



**THE DATASHEET OF
HC-49/U-S25000000ABJB**



AT-CUT CRYSTAL UNIT (Metal-can Type)

RoHS compliant

HC-49/U-S



■ FEATURES

- Frequency range : 3.5 ~ 50.0MHz
- External dimensions (mm)
L : 11.5 x W : 4.66 x H : 3.5
- Applications
Consumer products

■ DIMENSION [mm]

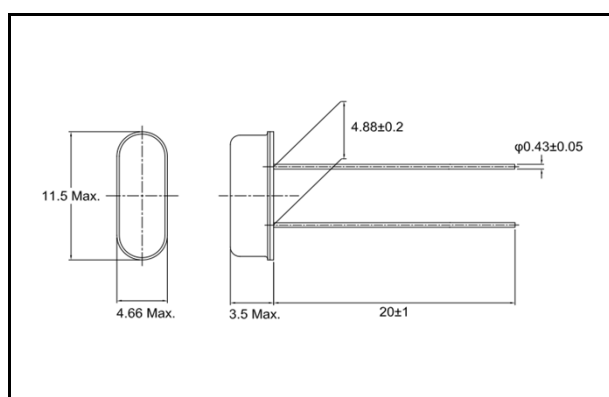

■ STANDARD SPECIFICATIONS

Item	Model	HC-49/U-S	Conditions
Nominal Frequency	f_0	3.5MHz ~ 30.0MHz (Fundamental) 30.0MHz ~ 50.0MHz (3rd Overtone)	Please contact us for frequencies available
Frequency Tolerance	$\Delta f/f_0$	± 30 ppm	at 25°C
Frequency Tolerance over Operating Temperature Range	$\Delta f/f_0$	below 6.0MHz: ± 50 ppm above 6.0MHz: ± 30 ppm	-10°C ~ +60°C
Operating Temperature Range	T _{OPR}	-20°C ~ +70°C	
Storage Temperature Range	T _{STR}	-40°C ~ +85°C	
Motional (series) resistance	R ₁	Refer to the following table	at 25°C
Load capacitance	C _L	Fundamental: 10.0pF ~ ∞ 3rd Overtone: 5.0pF ~ ∞	Please specify your requirement
Shunt capacitance	C ₀	7.0pF Max.	
Level of drive	D _L	100 μW	
Insulation Resistance	I _R	500MΩ Min.	DC100V ± 15V
Aging (first year)	$\Delta f/f_0$	± 5 ppm Max.	25°C ± 3°C

■ MOTIONAL (SERIES) RESISTANCE (R₁)

Freq. Range (MHz)	3.5 ≤ f ₀ < 4.0	4.0 ≤ f ₀ < 6.0	6.0 ≤ f ₀ < 10.0	10.0 ≤ f ₀ < 14.0	14.0 ≤ f ₀ < 30.0	30.0 ≤ f ₀ < 36.0	36.0 ≤ f ₀ ≤ 50.0
Mode	Fundamental	Fundamental	Fundamental	Fundamental	Fundamental	3rd Overtone	3rd Overtone
R ₁	200Ω Max.	150Ω Max.	100Ω Max.	80Ω Max.	50Ω Max.	140Ω Max.	100Ω Max.

■ PART NUMBERING SYSTEM

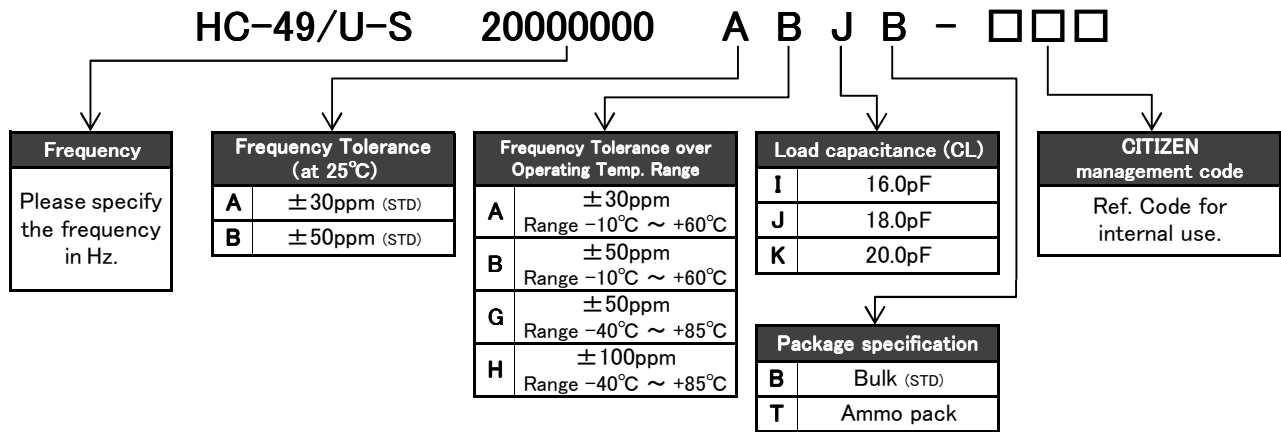

*Please contact us for specifications available.

■ Part Marking [standard]



f : The first 4 digits of Frequency including the decimal point

C : Manufacture's ID Code

y : The last digit of production year

m : Production month (See Table.1)

Table.1

Month	Jan	Feb	...	Sep	Oct	Nov	Dec
Code	1	2	...	9	X	Y	Z

■ Taping dimension : 2,000pcs/Ammo pack [mm]

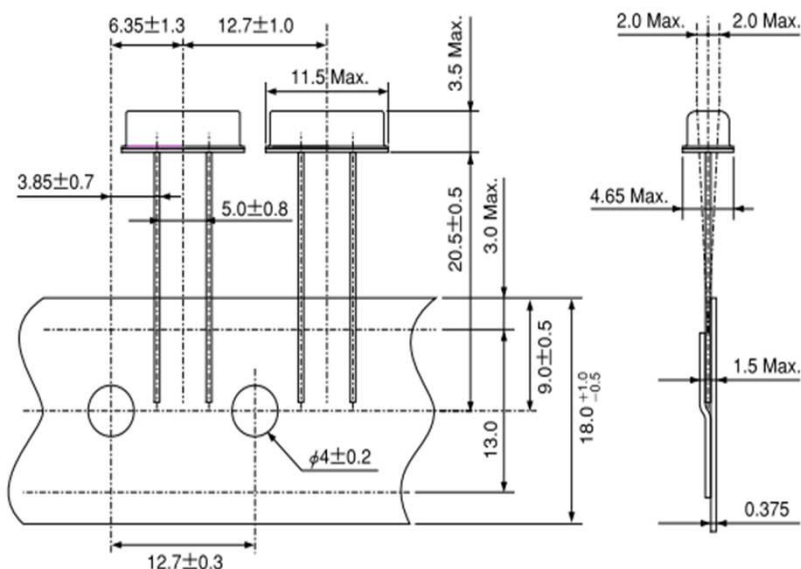

Product specifications are subject to change without notice.

Rev.2

Looking for pricing, stock, or lifecycle information?

Click below to explore more details on WIN SOURCE:

- ⊖ [View HC-49/U-S25000000ABJB on WIN SOURCE](#)
- ⊖ [Citizen Finedevice Co Ltd Information](#)

Optimize Your Supply Chain with WIN SOURCE Solutions

- ✓ Global Sourcing Solution
- ✓ Obsolete Management
- ✓ Cost Control Management
- ✓ Shortage Management
- ✓ Alternative Solution
- ✓ Excess Inventory Management