



**THE DATASHEET OF
BUK9832-55A,115**





BUK9832-55A

N-channel TrenchMOS logic level FET

Rev. 02 — 1 June 2010

Product data sheet

1. Product profile

1.1 General description

Logic level N-channel enhancement mode Field-Effect Transistor (FET) in a plastic package using TrenchMOS technology. This product has been designed and qualified to the appropriate AEC standard for use in automotive critical applications.

1.2 Features and benefits

- Low conduction losses due to low on-state resistance
- Suitable for logic level gate drive sources
- Q101 compliant

1.3 Applications

- 12 V and 24 V loads
- Motors, lamps and solenoids
- Automotive and general purpose power switching

1.4 Quick reference data

Table 1. Quick reference data

Symbol	Parameter	Conditions	Min	Typ	Max	Unit
V_{DS}	drain-source voltage	$T_j \geq 25\text{ °C}$; $T_j \leq 150\text{ °C}$	-	-	55	V
I_D	drain current	$V_{GS} = 5\text{ V}$; $T_{sp} = 25\text{ °C}$; see Figure 1 ; see Figure 3	-	-	12	A
P_{tot}	total power dissipation	$T_{sp} = 25\text{ °C}$; see Figure 2	-	-	8	W
Static characteristics						
$R_{DS(on)}$	drain-source on-state resistance	$V_{GS} = 4.5\text{ V}$; $I_D = 8\text{ A}$; $T_j = 25\text{ °C}$	-	-	36	m Ω
		$V_{GS} = 10\text{ V}$; $I_D = 8\text{ A}$; $T_j = 25\text{ °C}$	-	25	29	m Ω
		$V_{GS} = 5\text{ V}$; $I_D = 8\text{ A}$; $T_j = 25\text{ °C}$; see Figure 12 ; see Figure 13	-	27	32	m Ω
Avalanche ruggedness						
$E_{DS(AL)S}$	non-repetitive drain-source avalanche energy	$I_D = 10\text{ A}$; $V_{sup} \leq 55\text{ V}$; $R_{GS} = 50\text{ }\Omega$; $V_{GS} = 5\text{ V}$; $T_{j(init)} = 25\text{ °C}$; unclamped	-	-	100	mJ

2. Pinning information

Table 2. Pinning information

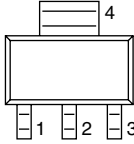
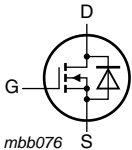
Pin	Symbol	Description	Simplified outline	Graphic symbol
1	G	gate	 <p>SOT223 (SC-73)</p>	 <p>mbb076</p>
2	D	drain		
3	S	source		
4	D	drain		

3. Ordering information

Table 3. Ordering information

Type number	Package		
	Name	Description	Version
BUK9832-55A	SC-73	plastic surface-mounted package with increased heatsink; 4 leads	SOT223

4. Limiting values

Table 4. Limiting values

In accordance with the Absolute Maximum Rating System (IEC 60134).

Symbol	Parameter	Conditions	Min	Typ	Max	Unit
V_{DS}	drain-source voltage	$T_j \geq 25\text{ °C}; T_j \leq 150\text{ °C}$	-	-	55	V
V_{DGR}	drain-gate voltage	$R_{GS} = 20\text{ k}\Omega$	-	-	55	V
V_{GS}	gate-source voltage		-10	-	10	V
I_D	drain current	$T_{sp} = 25\text{ °C}; V_{GS} = 5\text{ V};$ see Figure 1 ; see Figure 3	-	-	12	A
		$T_{sp} = 100\text{ °C}; V_{GS} = 5\text{ V};$ see Figure 1	-	-	7	A
I_{DM}	peak drain current	$T_{sp} = 25\text{ °C}; t_p \leq 10\text{ }\mu\text{s};$ pulsed; see Figure 3	-	-	47	A
P_{tot}	total power dissipation	$T_{sp} = 25\text{ °C};$ see Figure 2	-	-	8	W
T_{stg}	storage temperature		-55	-	150	°C
T_j	junction temperature		-55	-	150	°C
V_{GSM}	peak gate-source voltage	pulsed; $t_p \leq 50\text{ }\mu\text{s}$	-15	-	15	V

Source-drain diode

I_S	source current	$T_{sp} = 25\text{ °C}$	-	-	12	A
I_{SM}	peak source current	$t_p \leq 10\text{ }\mu\text{s};$ pulsed; $T_{sp} = 25\text{ °C}$	-	-	47	A

Avalanche ruggedness

$E_{DS(AL)S}$	non-repetitive drain-source avalanche energy	$I_D = 10\text{ A}; V_{sup} \leq 55\text{ V}; R_{GS} = 50\text{ }\Omega;$ $V_{GS} = 5\text{ V}; T_{j(\text{init})} = 25\text{ °C};$ unclamped	-	-	100	mJ
---------------	----------------------------------------------	--------------------------------------------------------------------------------------------------------------------------------------------------	---	---	-----	----

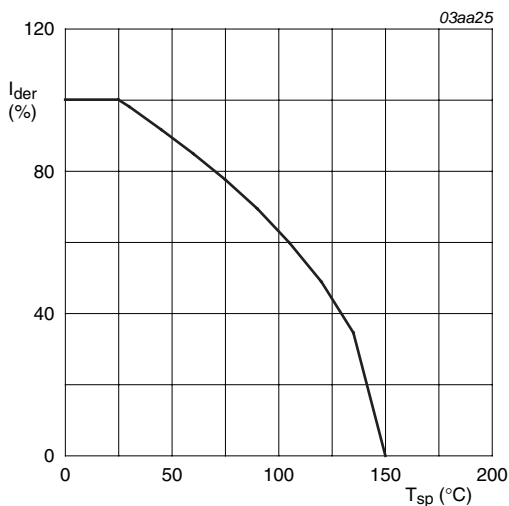

$$I_{der} = \frac{I_D}{I_{D(25^\circ\text{C})}} \times 100\%$$

Fig 1. Normalized continuous drain current as a function of solder point temperature

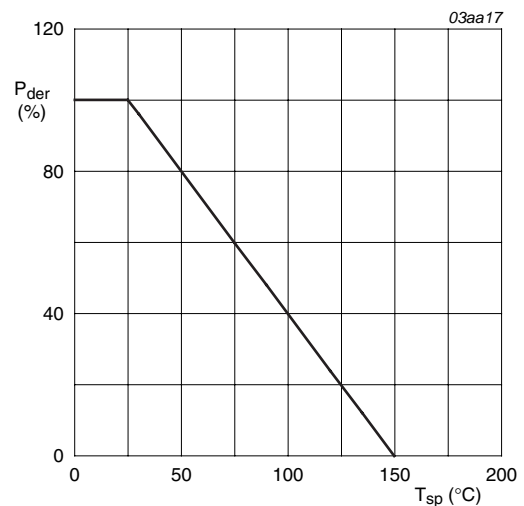

$$P_{der} = \frac{P_{tot}}{P_{tot(25^\circ\text{C})}} \times 100\%$$

Fig 2. Normalized total power dissipation as a function of solder point temperature

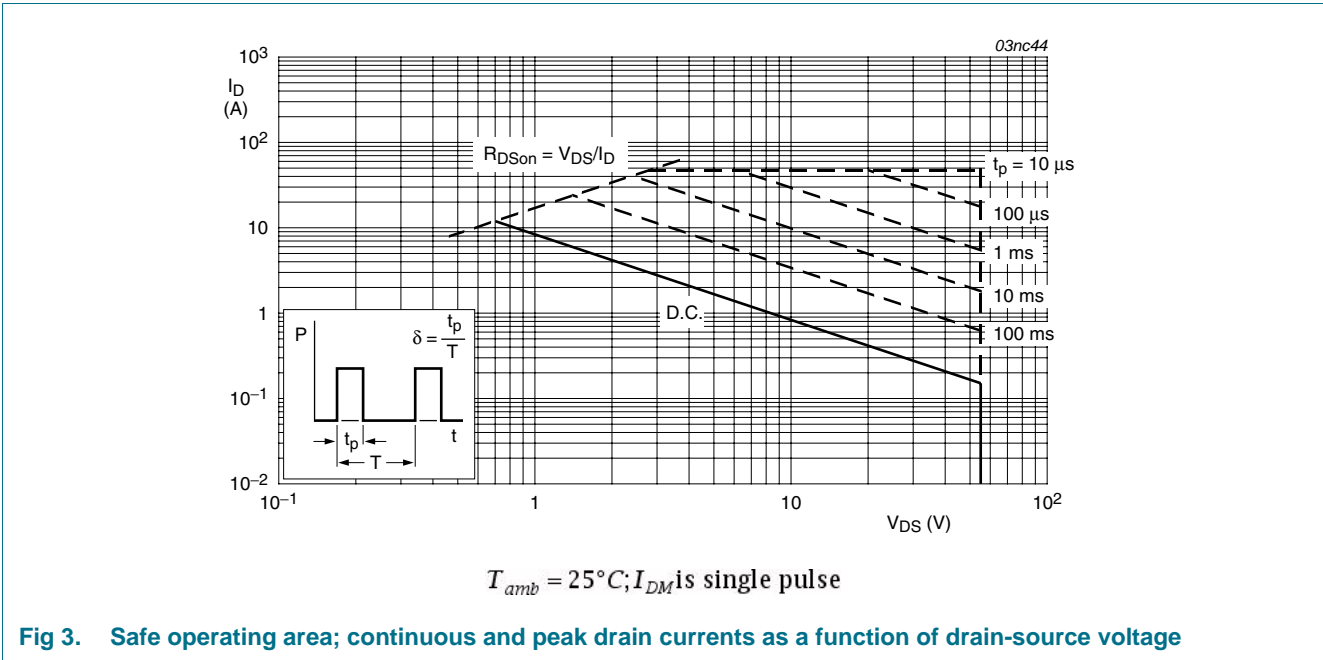

5. Thermal characteristics

Table 5. Thermal characteristics

Symbol	Parameter	Conditions	Min	Typ	Max	Unit
$R_{th(j-sp)}$	thermal resistance from junction to solder point		-	-	15	K/W
$R_{th(j-a)}$	thermal resistance from junction to ambient	see Figure 4	-	70	-	K/W

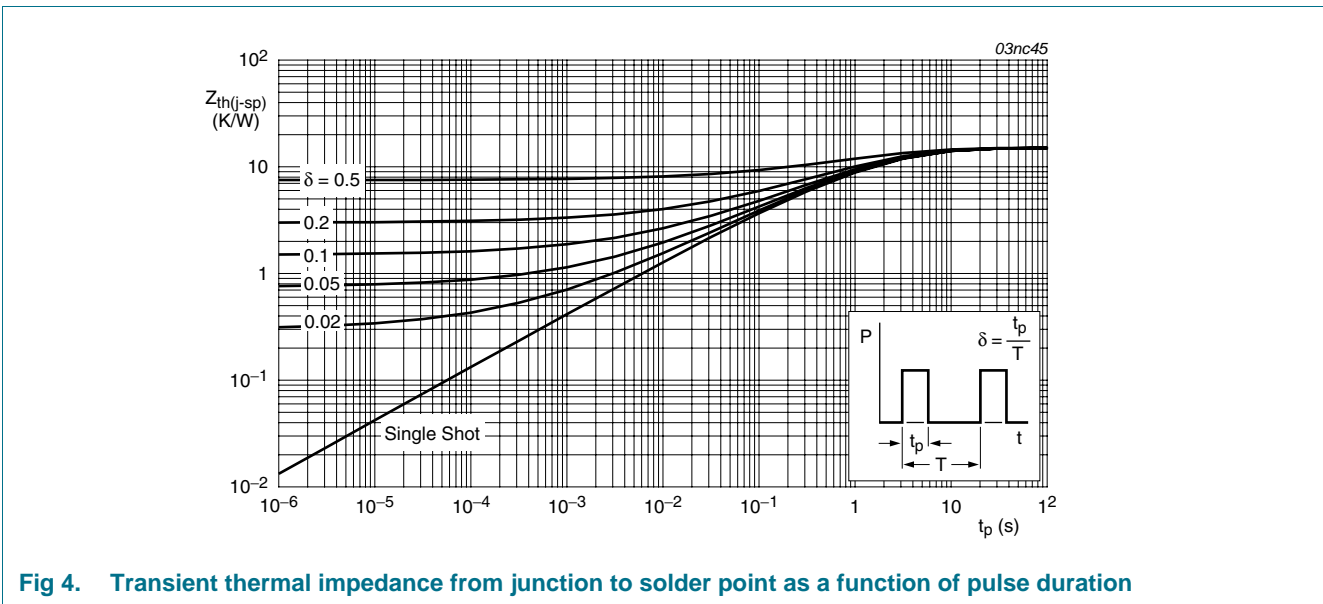

6. Characteristics

Table 6. Characteristics

Symbol	Parameter	Conditions	Min	Typ	Max	Unit
Static characteristics						
$V_{(BR)DSS}$	drain-source breakdown voltage	$I_D = 0.25 \text{ mA}; V_{GS} = 0 \text{ V}; T_j = -55 \text{ }^\circ\text{C}$	50	-	-	V
		$I_D = 0.25 \text{ mA}; V_{GS} = 0 \text{ V}; T_j = 25 \text{ }^\circ\text{C}$	55	-	-	V
$V_{GS(th)}$	gate-source threshold voltage	$I_D = 1 \text{ mA}; V_{DS} = V_{GS}; T_j = 25 \text{ }^\circ\text{C};$ see Figure 11	1	1.5	2	V
		$I_D = 1 \text{ mA}; V_{DS} = V_{GS}; T_j = -55 \text{ }^\circ\text{C};$ see Figure 11	-	-	2.3	V
		$I_D = 1 \text{ mA}; V_{DS} = V_{GS}; T_j = 150 \text{ }^\circ\text{C};$ see Figure 11	0.6	-	-	V
I_{DSS}	drain leakage current	$V_{DS} = 55 \text{ V}; V_{GS} = 0 \text{ V}; T_j = 150 \text{ }^\circ\text{C}$	-	-	500	μA
		$V_{DS} = 55 \text{ V}; V_{GS} = 0 \text{ V}; T_j = 25 \text{ }^\circ\text{C}$	-	0.05	10	μA
I_{GSS}	gate leakage current	$V_{DS} = 0 \text{ V}; V_{GS} = 10 \text{ V}; T_j = 25 \text{ }^\circ\text{C}$	-	2	100	nA
		$V_{DS} = 0 \text{ V}; V_{GS} = -10 \text{ V}; T_j = 25 \text{ }^\circ\text{C}$	-	2	100	nA
$R_{DS(on)}$	drain-source on-state resistance	$V_{GS} = 4.5 \text{ V}; I_D = 8 \text{ A}; T_j = 25 \text{ }^\circ\text{C}$	-	-	36	m Ω
		$V_{GS} = 5 \text{ V}; I_D = 8 \text{ A}; T_j = 150 \text{ }^\circ\text{C};$ see Figure 12 ; see Figure 13	-	-	59	m Ω
		$V_{GS} = 10 \text{ V}; I_D = 8 \text{ A}; T_j = 25 \text{ }^\circ\text{C}$	-	25	29	m Ω
		$V_{GS} = 5 \text{ V}; I_D = 8 \text{ A}; T_j = 25 \text{ }^\circ\text{C};$ see Figure 12 ; see Figure 13	-	27	32	m Ω
Dynamic characteristics						
C_{iss}	input capacitance	$V_{GS} = 0 \text{ V}; V_{DS} = 25 \text{ V}; f = 1 \text{ MHz};$ $T_j = 25 \text{ }^\circ\text{C};$ see Figure 14	-	1195	1594	pF
C_{oss}	output capacitance		-	212	254	pF
C_{rss}	reverse transfer capacitance		-	144	198	pF
$t_{d(on)}$	turn-on delay time	$V_{DS} = 30 \text{ V}; R_L = 1.2 \text{ } \Omega; V_{GS} = 5 \text{ V};$ $R_{G(ext)} = 10 \text{ } \Omega; T_j = 25 \text{ }^\circ\text{C}$	-	14	-	ns
t_r	rise time		-	125	-	ns
$t_{d(off)}$	turn-off delay time		-	64	-	ns
t_f	fall time		-	68	-	ns
Source-drain diode						
V_{SD}	source-drain voltage	$I_S = 18 \text{ A}; V_{GS} = 0 \text{ V}; T_j = 25 \text{ }^\circ\text{C};$ see Figure 15	-	0.85	1.2	V
t_{rr}	reverse recovery time	$I_S = 20 \text{ A}; dI_S/dt = -100 \text{ A}/\mu\text{s};$ $V_{GS} = -10 \text{ V}; V_{DS} = 30 \text{ V}; T_j = 25 \text{ }^\circ\text{C}$	-	51	-	ns
Q_r	recovered charge		-	80	-	nC

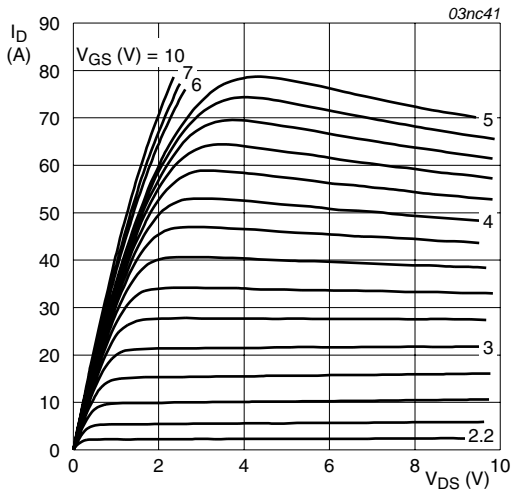

$T_j = 25^\circ\text{C}$

Fig 5. Output characteristics: drain current as a function of drain-source voltage; typical values

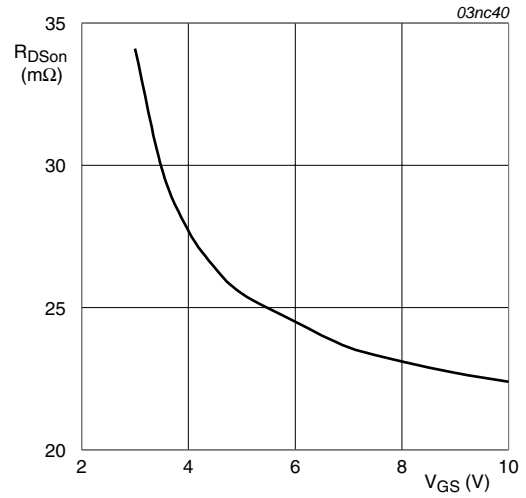

$T_j = 25^\circ\text{C}; I_D = 15\text{A}$

Fig 6. Drain-source on-state resistance as a function of gate-source voltage; typical values

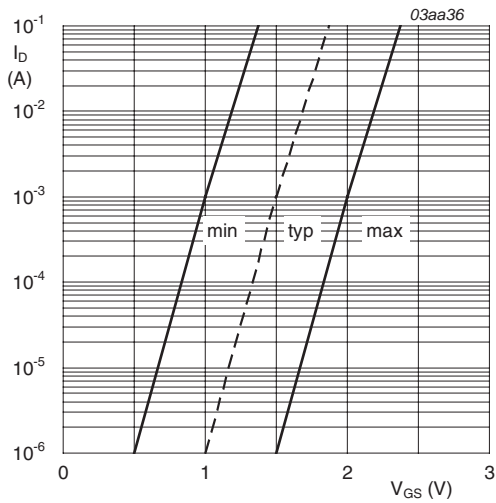

$T_j = 25^\circ\text{C}; V_{DS} = V_{GS}$

Fig 7. Sub-threshold drain current as a function of gate-source voltage

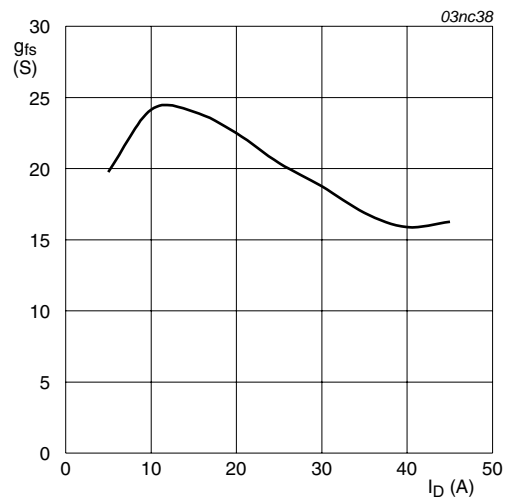

$T_j = 25^\circ\text{C}; V_{DS} = 25\text{V}$

Fig 8. Forward transconductance as a function of drain current; typical values

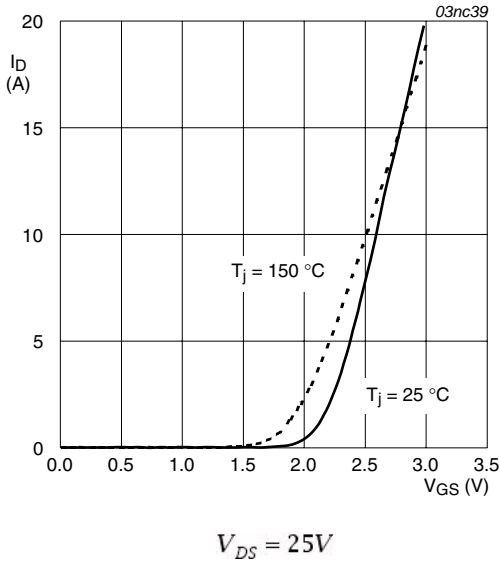

Fig 9. Transfer characteristics: drain current as a function of gate-source voltage; typical values

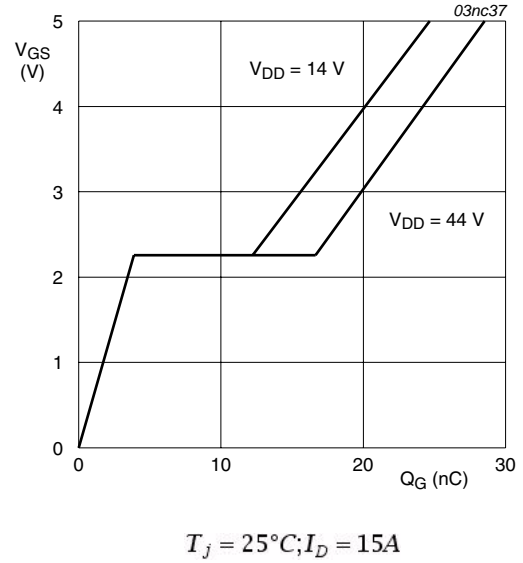

Fig 10. Gate-source voltage as a function of turn-on gate charge; typical values

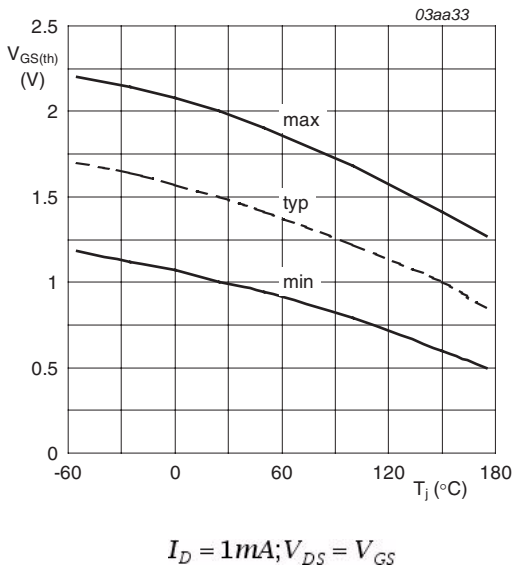

Fig 11. Gate-source threshold voltage as a function of junction temperature

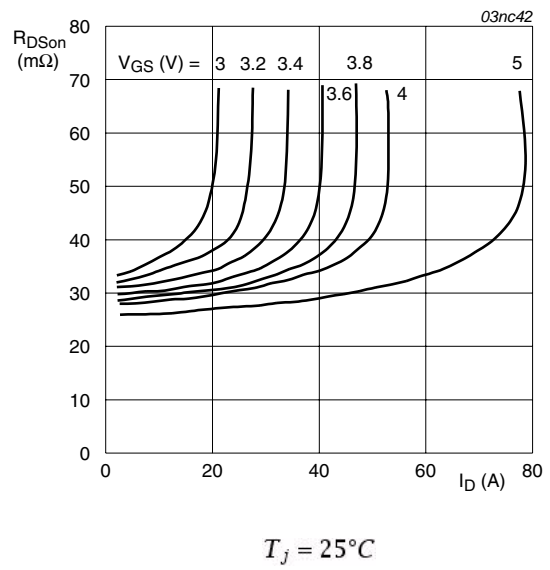
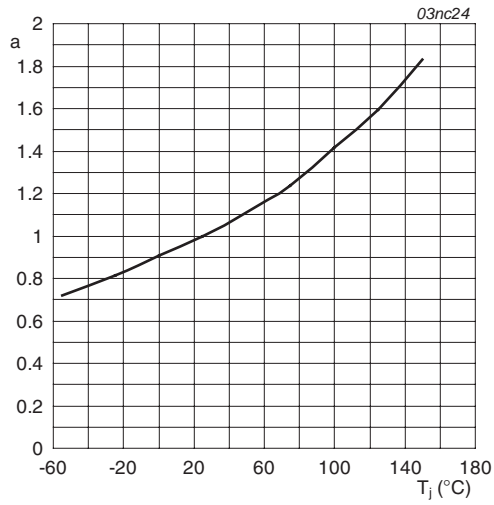
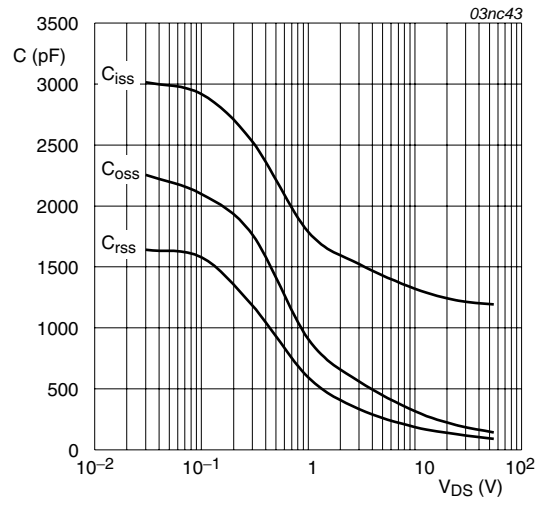

Fig 12. Drain-source on-state resistance as a function of drain current; typical values



$$a = \frac{R_{DSon}}{R_{DSon(25^{\circ}\text{C})}}$$

Fig 13. Normalized drain source on-state resistance factor as a function of junction temperature



$V_{GS} = 0\text{ V}; f = 1\text{ MHz}$

Fig 14. Input, output and reverse transfer capacitances as a function of drain-source voltage; typical values

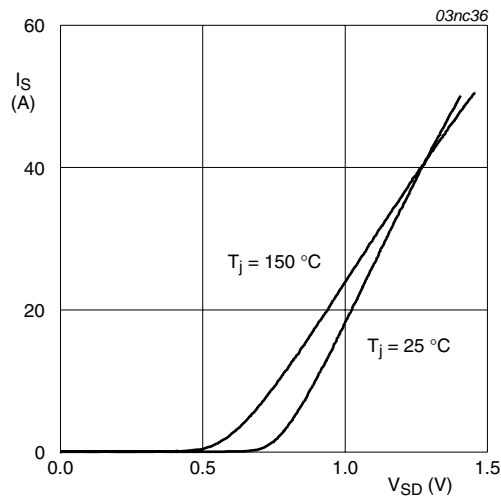

$V_{GS} = 0\text{ V}$

Fig 15. Reverse diode current as a function of reverse diode voltage; typical value

7. Package outline

Plastic surface-mounted package with increased heatsink; 4 leads

SOT223

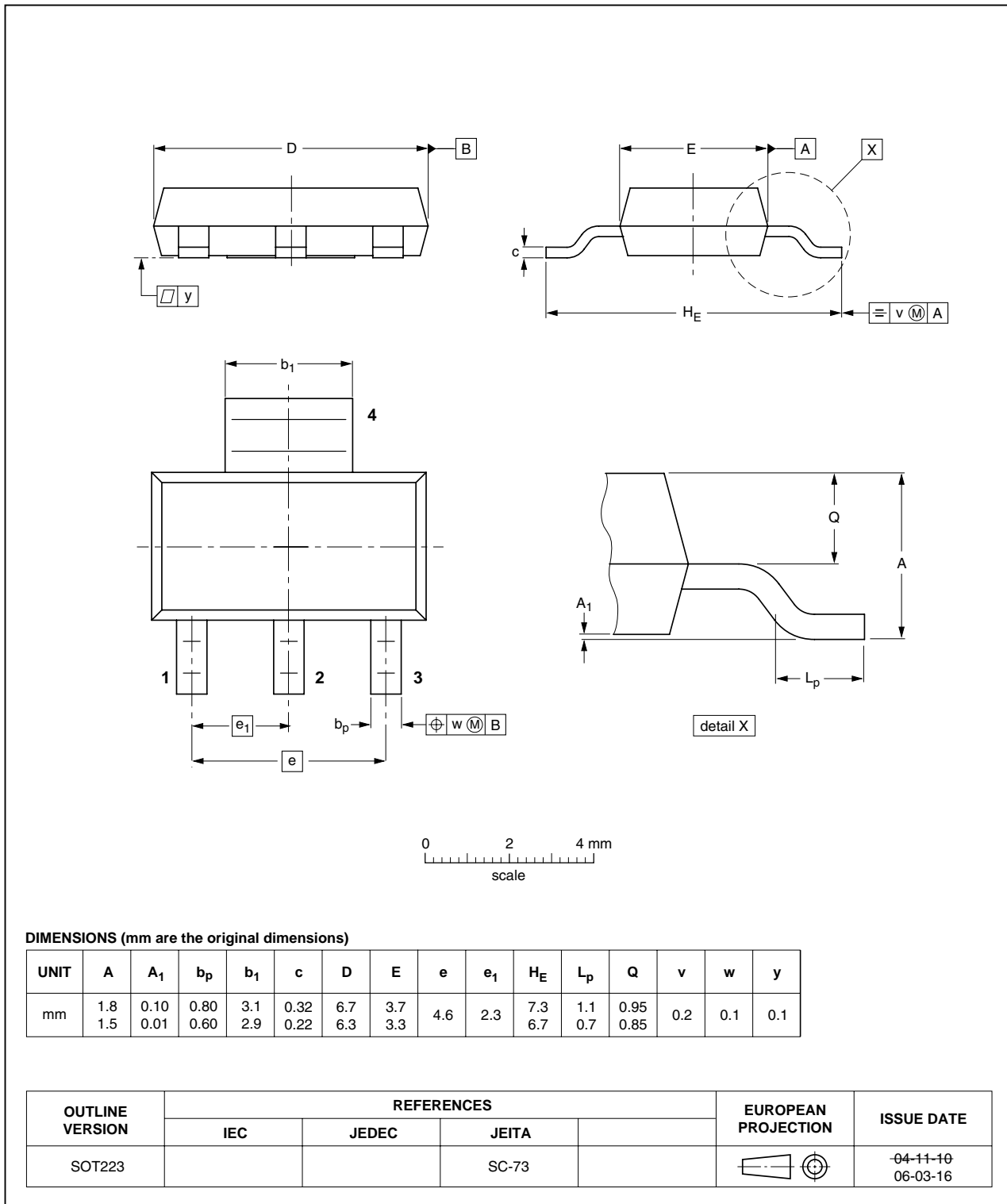

Fig 16. Package outline SOT223 (SC-73)

8. Revision history

Table 7. Revision history

Document ID	Release date	Data sheet status	Change notice	Supersedes
BUK9832-55A v.2	20100601	Product data sheet	-	BUK9832-55A-01
Modifications:	<ul style="list-style-type: none">• The format of this data sheet has been redesigned to comply with the new identity guidelines of NXP Semiconductors.• Legal texts have been adapted to the new company name where appropriate.			
BUK9832-55A-01 (9397 750 07734)	20010131	Product specification	-	-

9. Legal information

9.1 Data sheet status

Document status ^{[1][2]}	Product status ^[3]	Definition
Objective [short] data sheet	Development	This document contains data from the objective specification for product development.
Preliminary [short] data sheet	Qualification	This document contains data from the preliminary specification.
Product [short] data sheet	Production	This document contains the product specification.

[1] Please consult the most recently issued document before initiating or completing a design.

[2] The term 'short data sheet' is explained in section "Definitions".

[3] The product status of device(s) described in this document may have changed since this document was published and may differ in case of multiple devices. The latest product status information is available on the Internet at URL <http://www.nexperia.com>.

9.2 Definitions

Draft — The document is a draft version only. The content is still under internal review and subject to formal approval, which may result in modifications or additions. Nexperia does not give any representations or warranties as to the accuracy or completeness of information included herein and shall have no liability for the consequences of use of such information.

Short data sheet — A short data sheet is an extract from a full data sheet with the same product type number(s) and title. A short data sheet is intended for quick reference only and should not be relied upon to contain detailed and full information. For detailed and full information see the relevant full data sheet, which is available on request via the local Nexperia sales office. In case of any inconsistency or conflict with the short data sheet, the full data sheet shall prevail.

Product specification — The information and data provided in a Product data sheet shall define the specification of the product as agreed between Nexperia and its customer, unless Nexperia and customer have explicitly agreed otherwise in writing. In no event however, shall an agreement be valid in which the Nexperia product is deemed to offer functions and qualities beyond those described in the Product data sheet.

9.3 Disclaimers

Limited warranty and liability — Information in this document is believed to be accurate and reliable. However, Nexperia does not give any representations or warranties, expressed or implied, as to the accuracy or completeness of such information and shall have no liability for the consequences of use of such information.

In no event shall Nexperia be liable for any indirect, incidental, punitive, special or consequential damages (including - without limitation - lost profits, lost savings, business interruption, costs related to the removal or replacement of any products or rework charges) whether or not such damages are based on tort (including negligence), warranty, breach of contract or any other legal theory.

Notwithstanding any damages that customer might incur for any reason whatsoever, Nexperia's aggregate and cumulative liability towards customer for the products described herein shall be limited in accordance with the *Terms and conditions of commercial sale* of Nexperia.

Right to make changes — Nexperia reserves the right to make changes to information published in this document, including without limitation specifications and product descriptions, at any time and without notice. This document supersedes and replaces all information supplied prior to the publication hereof.

Suitability for use in automotive applications — This Nexperia product has been qualified for use in automotive applications. The product is not designed, authorized or warranted to be suitable for use in medical, military, aircraft, space or life support equipment, nor in applications where failure or malfunction of a Nexperia product can reasonably be expected to result in personal injury, death or severe property or environmental damage. Nexperia accepts no liability for inclusion and/or use of Nexperia products in such equipment or applications and therefore such inclusion and/or use is at the customer's own risk.

Applications — Applications that are described herein for any of these products are for illustrative purposes only. Nexperia makes no representation or warranty that such applications will be suitable for the specified use without further testing or modification.

Nexperia does not accept any liability related to any default, damage, costs or problem which is based on a weakness or default in the customer application/use or the application/use of customer's third party customer(s) (hereinafter both referred to as "Application"). It is customer's sole responsibility to check whether the Nexperia product is suitable and fit for the Application planned. Customer has to do all necessary testing for the Application in order to avoid a default of the Application and the product. Nexperia does not accept any liability in this respect.

Quick reference data — The Quick reference data is an extract of the product data given in the Limiting values and Characteristics sections of this document, and as such is not complete, exhaustive or legally binding. **Limiting values** — Stress above one or more limiting values (as defined in the Absolute Maximum Ratings System of IEC 60134) will cause permanent damage to the device. Limiting values are stress ratings only and (proper) operation of the device at these or any other conditions above those given in the Recommended operating conditions section (if present) or the Characteristics sections of this document is not warranted. Constant or repeated exposure to limiting values will permanently and irreversibly affect the quality and reliability of the device.

Terms and conditions of commercial sale — Nexperia products are sold subject to the general terms and conditions of commercial sale, as published at <http://www.nexperia.com/profile/terms>, unless otherwise agreed in a valid written individual agreement. In case an individual agreement is concluded only the terms and conditions of the respective agreement shall apply. Nexperia hereby expressly objects to applying the customer's general terms and conditions with regard to the purchase of Nexperia products by customer.

No offer to sell or license — Nothing in this document may be interpreted or construed as an offer to sell products that is open for acceptance or the grant, conveyance or implication of any license under any copyrights, patents or other industrial or intellectual property rights.

Export control — This document as well as the item(s) described herein may be subject to export control regulations. Export might require a prior authorization from national authorities.

10. Contact information

For more information, please visit: <http://www.nexperia.com>



For sales office addresses, please send an email to: salesaddresses@nexperia.com

11. Contents

1	Product profile	1
1.1	General description	1
1.2	Features and benefits	1
1.3	Applications	1
1.4	Quick reference data	1
2	Pinning information	2
3	Ordering information	2
4	Limiting values	3
5	Thermal characteristics	4
6	Characteristics	5
7	Package outline	9
8	Revision history	10
9	Legal information	11
9.1	Data sheet status	11
9.2	Definitions	11
9.3	Disclaimers	11
9.4	Trademarks	12
10	Contact information	12

Looking for pricing, stock, or lifecycle information?

Click below to explore more details on WIN SOURCE:

-  [View BUK9832-55A,115 on WIN SOURCE](#)
-  [NXP / Nexperia Information](#)

Optimize Your Supply Chain with WIN SOURCE Solutions

-  Global Sourcing Solution
-  Obsolete Management
-  Cost Control Management
-  Shortage Management
-  Alternative Solution
-  Excess Inventory Management