

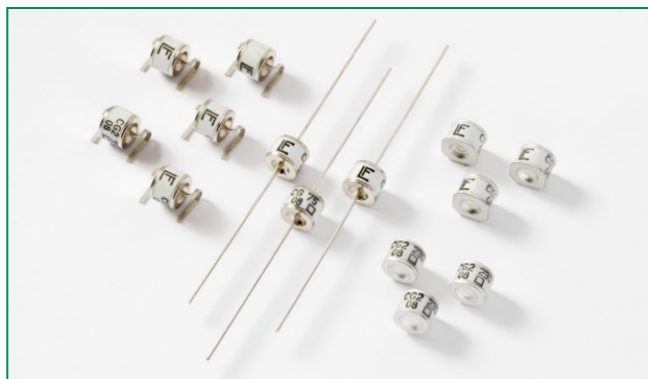



**THE DATASHEET OF
CG2470LSTR**



CG/CG2 Series



Agency Approvals

| AGENCY | AGENCY FILE NUMBER |
|---|----------------------|
|  | E128662 ¹ |
|  | E320116 ² |

NOTES:

1. Certified to UL 497B.
2. Only CG2300, CG2470, CG2600, CG2800 and CG221000. Certified to UL 1449.

2 Electrode GDT Graphical Symbol



Additional Information



Datasheet



Resources



Samples

Description

Littelfuse's highly reliable CG/CG2 Series GDTs provide a high degree of surge protection in a small size ideal for board level circuit protection.

GDTs function as switches which dissipate a minimum amount of energy and therefore handle currents that far surpass other types of transient voltage protection. Their gas-filled, rugged ceramic metal construction make them well suited to adverse environments.

The CG/CG2 series comes in a variety of forms including surface mount, core, straight and shaped leads, to serve a variety of mounting methods.

The CG Series (75V-110V) is ideal for protection of test and communication equipment and other devices in which low voltage limits and extremely low arc voltages are required.

The CG2 Series (145V-1000V) is ideal for protecting equipment where higher voltage limits and holdover voltages are necessary.

Features

- RoHS and Lead-free compliant
- Rugged Ceramic-Metal construction
- Low Capacitance (<1.5pf)
- Meets REA PE-80
- Available in surface mount, and a variety of lead options options
- RoHS Compliant and Lead-Free

Applications

- Communication lines and equipment
- CATV equipment
- Test equipment
- Data lines
- Power supplies
- Instrumentation circuits
- Medical electronics
- ADSL equipment
- Telecom SLIC protection

Electrical Characteristics

| Part Number | Device Specifications (at 25°C) | | | | | | Life Ratings | | | | | | | | | | | | |
|------------------------|---------------------------------|------|------|--|--|------------------------------|---------------------|--|------------------------------|--|---|--------------------------------------|----------------------------------|--|-----------|-----------------|------|-------|-------|
| | DC Breakdown in Volts (@100V/s) | | | Impulse Break-down in Volts (@100V/μs) | Impulse Break-down In Volts (@1 Kv/μsec) | Insulation Resistance | Capacitance (@1MHz) | Arc Voltage (on state Voltage) @1Amp Min | Surge Life (@500A 10/1000μs) | Nominal Impulse Discharge Current (8/20μs) | Nominal AC Discharge Current (10x1sec @50-60Hz) | AC Discharge Current (9 cycle @50Hz) | DC Holdover Voltage ² | Max Impulse Discharge Current (1 Application @ 10/350μs) | | | | | |
| | MIN | TYP | MAX | MAX | | MIN | MAX | TYP | | | | | TYP | | | | | | |
| CG75 | 60 | 75 | 90 | 400 | 650 | 10 ¹⁰ Ω (at 50V) | 1.5 pf | 15 V | 400 shots | 5 shots (@20kA) | 20 A | 100 A | 52 V | 4kA | | | | | |
| CG90 | 72 | 90 | 108 | 400 | 600 | | | | | | | | | | | | | | |
| CG90 SN | 72 | 90 | 108 | 400 | 600 | | | | | | | | | | | | | | |
| CG110 | 88 | 110 | 132 | 450 | 600 | 10 ¹⁰ Ω (at 100V) | | | | | | | 1.5 pf | 15 V | 400 shots | 5 shots (@20kA) | 20 A | 100 A | 2.5kA |
| CG2145 | 116 | 145 | 174 | 500 | 600 | | | | | | | | | | | | | | |
| CG2145 SN | 120 | 145 | 174 | 500 | 600 | | | | | | | | | | | | | | |
| CG2230 ¹ | 195 | 230 | 265 | 600 | 700 | | | | | | | | | | | | | | |
| CG2230 SN ¹ | 184 | 230 | 276 | 600 | 700 | | | | | | | | | | | | | | |
| CG2250 | 213 | 250 | 288 | 625 | 725 | | | | | | | | | | | | | | |
| CG2250 SN | 200 | 250 | 300 | 625 | 725 | | | | | | | | | | | | | | |
| CG2300 | 255 | 300 | 345 | 700 | 800 | | | | | | | | | | | | | | |
| CG2300 SN | 240 | 300 | 360 | 700 | 800 | | | | | | | | | | | | | | |
| CG2350 | 297 | 350 | 403 | 750 | 900 | | | | | | | | | | | | | | |
| CG2350 SN | 280 | 350 | 420 | 750 | 900 | | | | | | | | | | | | | | |
| CG2420 | 357 | 420 | 483 | 800 | 1000 | | | | | | | | | | | | | | |
| CG2470 ¹ | 400 | 470 | 540 | 850 | 1200 | | | | | | | | | | | | | | |
| CG2470 SN ¹ | 376 | 470 | 564 | 850 | 1200 | | | | | | | | | | | | | | |
| CG2600 ¹ | 510 | 600 | 690 | 1000 | 1400 | | | | | | | | | | | | | | |
| CG2600 SN ¹ | 480 | 600 | 720 | 1000 | 1400 | | | | | | | | | | | | | | |
| CG2800 ¹ | 680 | 800 | 920 | 1200 | 1500 | | | | | | | | | | | | | | |
| CG21000 ¹ | 850 | 1000 | 1150 | 1500 | 1600 | | | | | | | | | | | | | | |

NOTES:

- Certified to UL 1449.
- Reference REA PE-80, 0.2A. Tested to ITU-T Rec K.12 and REA PE 80 < 150 mSec.
- 5 x [5 (+) or 5 (-)] applications 20kA 8/20μSec. (75 to 600 volt devices.)
10 x [5 (+) and 5 (-)] applications 10kA 8/20μSec. (800 and 100 volt devices.)

Product Characteristics

| | | | |
|------------------------|--|--|---|
| Materials | LS, Axial: Device: Tin Plated 2–5 Microns Lead Wires: Tin Plated 17.5 ± 12.5 Microns Construction: Ceramic Insulator | Glow to arc transition current | < 0.5Amps |
| | Core: Device: Tin Plated 17.5 ± 12.5 Microns. Construction: Ceramic Insulator | Glow Voltage | 60-160 Volts |
| Product Marking | MS: Device: Dull Tin Plated 7–9 Microns Construction: Ceramic Insulator | Storage and Operational Temperature | -40 to +90 |
| | LF Logo, Voltage and date code; Black in positive print | Maximum Follow On Current¹ | 230 Volts r.m.s, 200 Amps. (800V and 1000V devices tested to UL1449 3rd edition) |

Device Dimensions

Leaded 'L' Type Straight Axial Devices

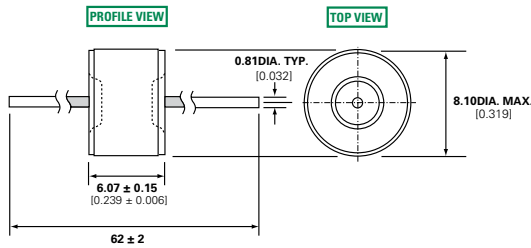

Leaded 'LS' Type Shaped Lead Devices

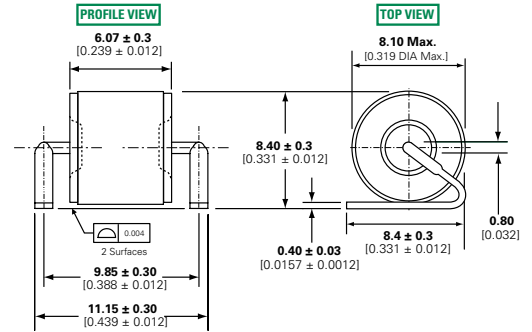

Core Devices

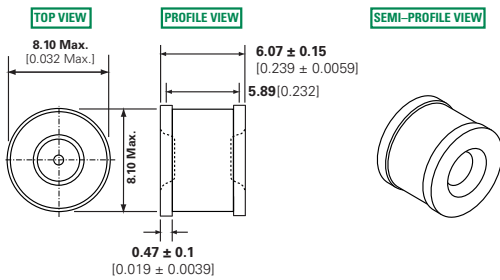

SOLDER PAD LAYOUT

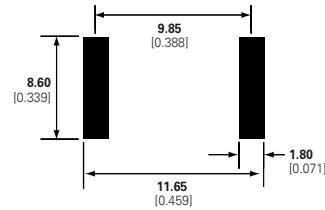

'MS' Type Devices

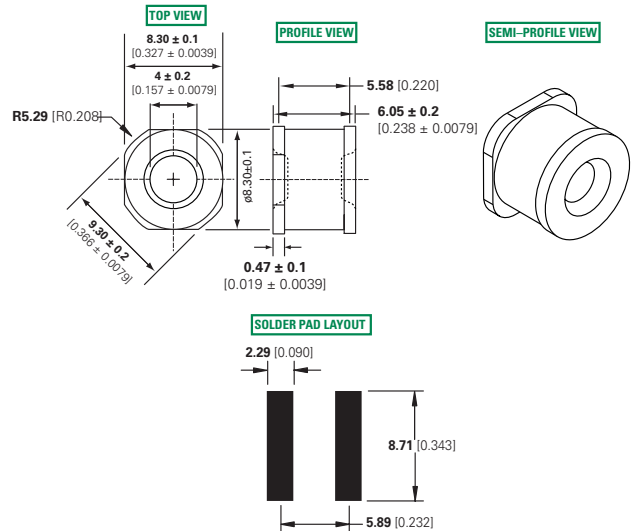

SOLDER PAD LAYOUT

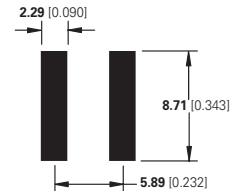

Soldering Parameters - Reflow Soldering (Surface Mount Devices)

| | | |
|--|------------------------------------|-------------------------|
| Reflow Condition | | Pb – Free assembly |
| Pre Heat | - Temperature Min ($T_{s(min)}$) | 150°C |
| | - Temperature Max ($T_{s(max)}$) | 200°C |
| | - Time (Min to Max) (t_s) | 60 – 180 secs |
| Average ramp up rate (Liquidus Temp (T_L) to peak) | | 3°C/second max |
| $T_{s(max)}$ to T_L - Ramp-up Rate | | 5°C/second max |
| Reflow | - Temperature (T_L) (Liquidus) | 217°C |
| | - Temperature (t_L) | 60 – 150 seconds |
| Peak Temperature (T_p) | | 260 ^{+0/-5} °C |
| Time within 5°C of actual peak Temperature (t_p) | | 10 – 30 seconds |
| Ramp-down Rate | | 6°C/second max |
| Time 25°C to peak Temperature (T_p) | | 8 minutes Max. |
| Do not exceed | | 260°C |

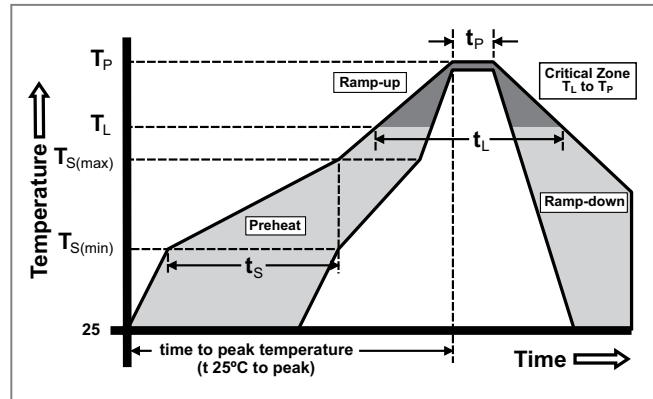

Soldering Parameters - Wave Soldering (Thru-Hole Devices)

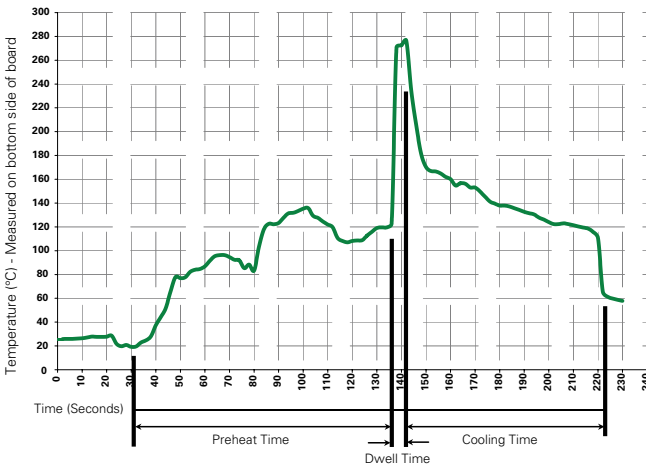

Recommended Process Parameters:

| Wave Parameter | Lead-Free Recommendation |
|---|--------------------------|
| Preheat: (Depends on Flux Activation Temperature) (Typical Industry Recommendation) | |
| Temperature Minimum: | 100° C |
| Temperature Maximum: | 150° C |
| Preheat Time: | 60-180 seconds |
| Solder Pot Temperature: | 280° C Maximum |
| Solder Dwell Time: | 2-5 seconds |

Soldering Parameters - Hand Soldering

Solder Iron Temperature: 350° C +/- 5°C
Heating Time: 5 seconds max.

Packaging Dimensions

For 'L' Type Axial Lead Items

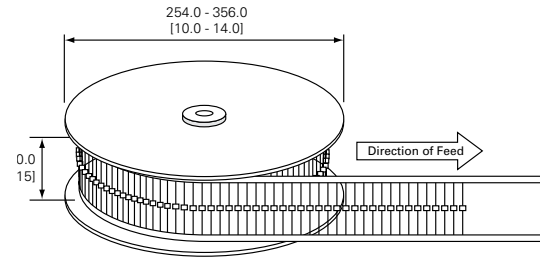
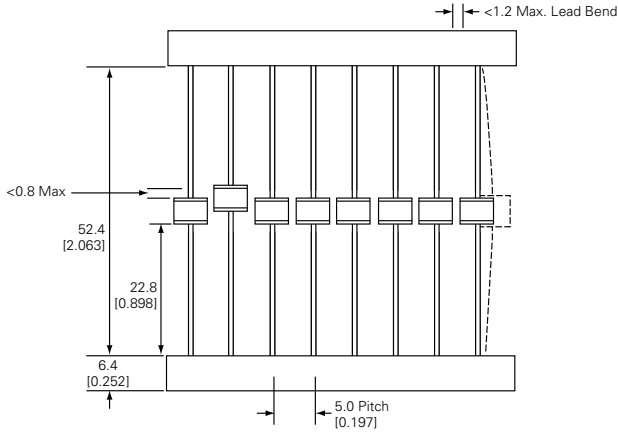

Core and 'MS' Type Items

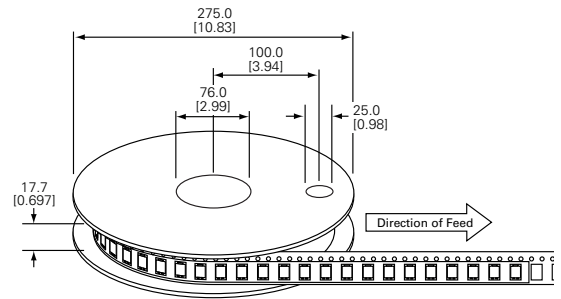
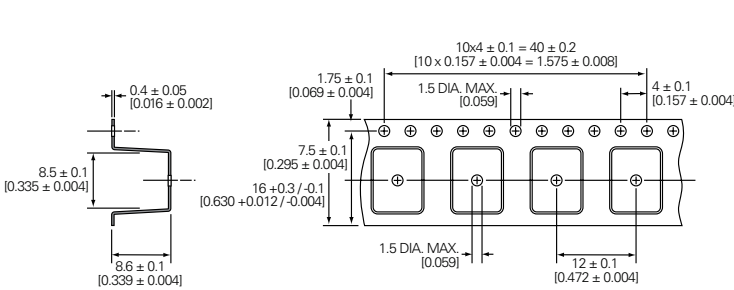

For 'LS' Type Shaped Lead Items

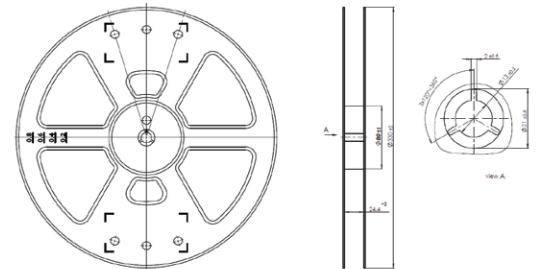
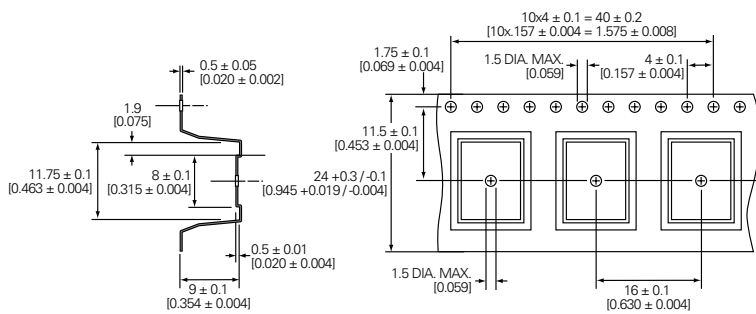

Part Numbering System and Ordering Information

CG2 XXX XX * XX

Series

CG – for 75, 90, or 110V
CG2 – for 145V to 1000V

Breakdown Voltage

| | |
|-----|------|
| 75 | 300 |
| 90 | 350 |
| 110 | 470 |
| 145 | 600 |
| 230 | 800 |
| 250 | 1000 |

Lead Option Code

(Blank) = No Leads / Core
L = Straight Leads
LS = Shaped Leads
MS = Surface Mount

Option Code*

SN = may have different DC Breakover Voltage Limit. Please refer to Electrical Characteristics table for additional information.

Packaging Option Code

(Blank) = No Leads / Core, Bulk Bag - 400 pcs
 L(Blank) = Straight Lead, Tray - 50 pcs
LTR = Straight Lead, Tape & Reel per EIA RS-296-E - 500 per reel
 LS(Blank) = Shaped Lead (see LS dimensions), Tape & Reel - 500 per reel

Examples:

- CG75** – A non-leaded 75V device
- CG2230L** – A leaded 230V device
- CG2800LTR** – A leaded 800V device, tape-and-reel (per EIA standard RS-296-D)

Notes:

CG/CG2 devices with other breakdown voltages in the 75-1000 V range are available upon request.

Looking for pricing, stock, or lifecycle information?

Click below to explore more details on WIN SOURCE:

 [View CG2470LSTR on WIN SOURCE](#)

 [Littelfuse Inc. Information](#)

Optimize Your Supply Chain with WIN SOURCE Solutions

-  Global Sourcing Solution
-  Obsolete Management
-  Cost Control Management
-  Shortage Management
-  Alternative Solution
-  Excess Inventory Management