



**THE DATASHEET OF
CLF1G0060-30U**



CLF1G0060-30; CLF1G0060S-30

Broadband RF power GaN HEMT

AMPLEON

Rev. 7 — 5 February 2018

Product data sheet

1. Product profile

1.1 General description

The CLF1G0060-30 and CLF1G0060S-30 are 30 W general purpose broadband GaN HEMTs usable from DC to 6.0 GHz.

Table 1. CW and pulsed RF application information

Typical RF performance at $T_{case} = 25\text{ }^{\circ}\text{C}$; $I_{Dq} = 70\text{ mA}$; $V_{DS} = 50\text{ V}$ in a class-AB broadband demo board.

Test signal	f	P_L	G_p	η_D
	(MHz)	(W)	(dB)	(%)
1-Tone CW	500	30	15.6	60.7
	1000	30	13.9	50.3
	1500	30	13.7	50.8
	2000	30	12.6	49
	2500	30	14.2	55.6
1-Tone pulsed [1]	500	30	16.6	61
	1000	30	15.8	50
	1500	30	15.5	52.5
	2000	30	14.5	50
	2500	30	15.9	59

[1] Pulsed RF; $t_p = 100\text{ }\mu\text{s}$; $\delta = 10\text{ }\%$.

Table 2. 2-Tone CW application information

Typical 2-Tone performance at $T_{case} = 25\text{ }^{\circ}\text{C}$; $I_{Dq} = 150\text{ mA}$; $V_{DS} = 50\text{ V}$ in a class-AB broadband demo board.

Test signal	f	$P_{L(PEP)}$	IMD3
	(MHz)	(W)	(dBc)
2-Tone CW [1]	500	10	-38
	1000	10	-50
	1500	10	-45
	2000	10	-50
	2500	10	-43

[1] 2-Tone CW; $\Delta f = 1\text{ MHz}$.

1.2 Features and benefits

- Frequency of operation is from DC to 6.0 GHz
- 30 W general purpose broadband RF Power GaN HEMT
- Excellent ruggedness (VSWR = 10 : 1)
- High voltage operation (50 V)
- Thermally enhanced package

1.3 Applications

- Commercial wireless infrastructure (cellular, WiMAX)
- Radar
- Broadband general purpose amplifier
- Public mobile radios
- Industrial, scientific, medical
- Jammers
- EMC testing
- Defense application

2. Pinning information

Table 3. Pinning

Pin	Description	Simplified outline	Graphic symbol
CLF1G0060-30 (SOT1227A)			
1	drain		 aaa-003693
2	gate		
3	source [1]		
CLF1G0060S-30 (SOT1227B)			
1	drain		 aaa-003693
2	gate		
3	source [1]		

[1] Connected to flange.

3. Ordering information

Table 4. Ordering information

Type number	Package		Version
	Name	Description	
CLF1G0060-30	-	flanged ceramic package; 2 mounting holes; 2 leads	SOT1227A
CLF1G0060S-30	-	earless flanged ceramic package; 2 leads	SOT1227B

4. Limiting values

Table 5. Limiting values

In accordance with the Absolute Maximum Rating System (IEC 60134).

Symbol	Parameter	Conditions	Min	Max	Unit
V_{DS}	drain-source voltage		-	150	V
V_{GS}	gate-source voltage		-8	+3	V
I_{GF}	forward gate current	external $R_G = 5 \Omega$	-	11	mA
T_{stg}	storage temperature		-65	+150	°C
T_j	junction temperature	measured via IR scan	-	250	°C

5. Thermal characteristics

Table 6. Thermal characteristics

Symbol	Parameter	Conditions	Typ	Unit	
$R_{th(j-c)}$	thermal resistance from junction to case	$T_j = 200 \text{ °C}$	[1]	3.1	K/W

[1] T_j is measured via IR scan with case temperature of 85 °C and power dissipation of 34 W.

6. Characteristics

Table 7. DC Characteristics

$T_{case} = 25 \text{ °C}$; unless otherwise specified.

Symbol	Parameter	Conditions	Min	Typ	Max	Unit
$V_{(BR)DSS}$	drain-source breakdown voltage	$V_{GS} = -7 \text{ V}$; $I_{DS} = 7.2 \text{ mA}$	150	-	-	V
$V_{GS(th)}$	gate-source threshold voltage	$V_{DS} = 0.1 \text{ V}$; $I_{DS} = 7.2 \text{ mA}$	-2.4	-2	-1.6	V
I_{DSX}	drain cut-off current	$V_{DS} = 10 \text{ V}$; $V_{GS} = 3 \text{ V}$	-	5.1	-	A
g_{fs}	forward transconductance	$V_{DS} = 10 \text{ V}$; $V_{GS} = 0 \text{ V}$	-	1.1	-	S

Table 8. RF Characteristics

Test signal: pulsed RF; $f = 3 \text{ GHz}$; $t_p = 100 \mu\text{s}$; $\delta = 10 \%$; RF performance at $V_{DS} = 50 \text{ V}$;
 $I_{DQ} = 70 \text{ mA}$; $T_{case} = 25 \text{ °C}$; unless otherwise specified in a class-AB production circuit.

Symbol	Parameter	Conditions	Min	Typ	Max	Unit
η_D	drain efficiency	$P_L = 30 \text{ W}$	46	54	-	%
G_p	power gain	$P_L = 30 \text{ W}$	11.8	13.5	-	dB
RL_{in}	input return loss	$P_L = 30 \text{ W}$	-	-7	-	dB
$P_{droop(pulse)}$	pulse droop power	$P_L = 30 \text{ W}$	-	0.04	-	dB
t_r	rise time	$P_L = 30 \text{ W}$	-	5	-	ns
t_f	fall time	$P_L = 30 \text{ W}$	-	5	-	ns

7. Application information

7.1 Demo circuit

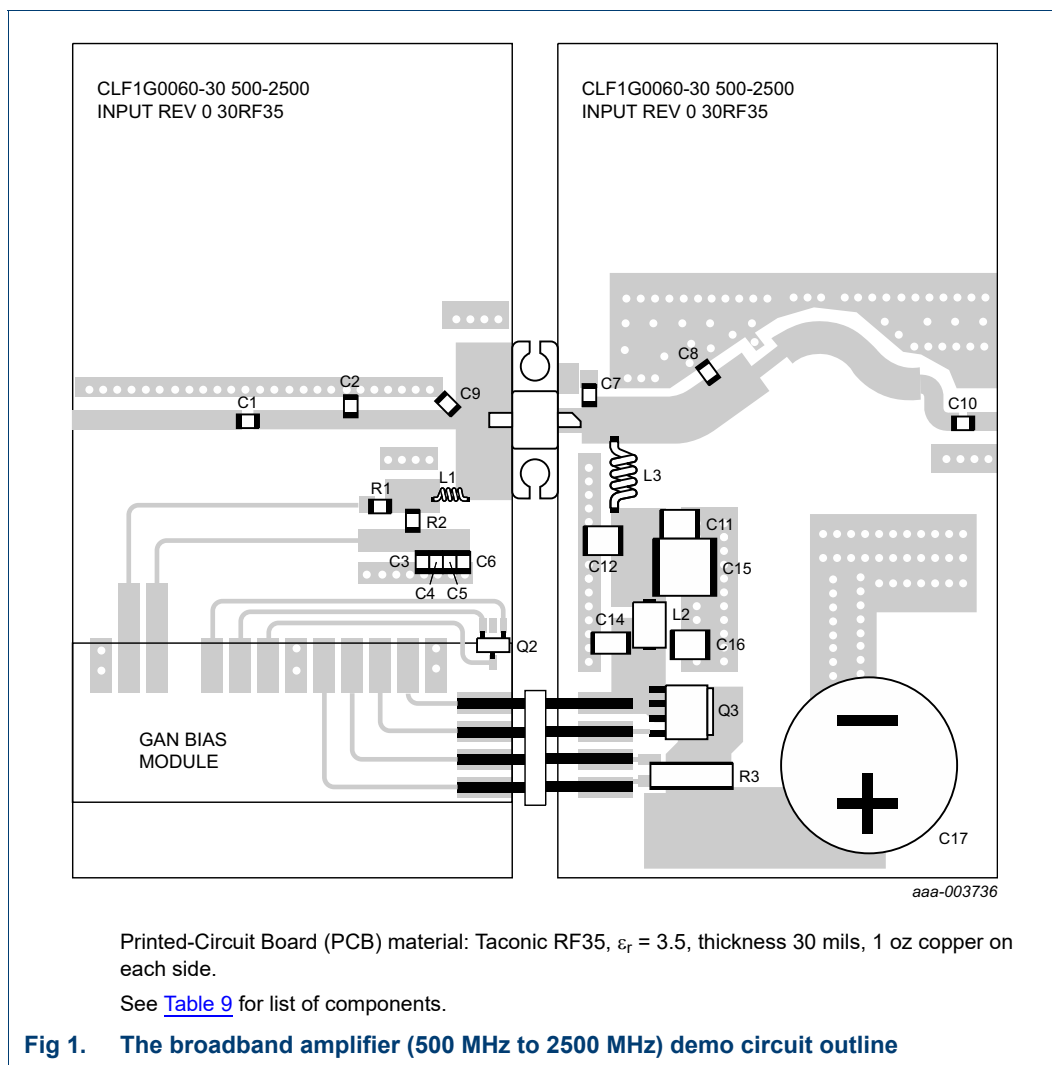

Table 9. List of components

See [Figure 1](#).

Component	Description	Value	Remarks
A1	GaN bias module v2	-	Ampleon
C1, C10	multilayer ceramic chip capacitor	8.2 pF	ATC 600F
C2, C7	multilayer ceramic chip capacitor	0.8 pF	ATC 600F
C3	electrolytic capacitor	100 nF, 50 V	SMD 0805
C4	electrolytic capacitor	10 nF, 50 V	SMD 0805
C5	electrolytic capacitor	22 pF, 100 V	SMD 0805
C6	electrolytic capacitor	1 nF, 100 V	SMD 1206
C8	multilayer ceramic chip capacitor	1.2 pF	ATC 600F
C9	multilayer ceramic chip capacitor	0.5 pF	ATC 600F

Table 9. List of components ...continued
See [Figure 1](#).

Component	Description	Value	Remarks
C11	multilayer ceramic chip capacitor	100 pF	ATC 100B
C12	multilayer ceramic chip capacitor	1 nF	ATC 700B
C14	electrolytic capacitor	1 μ F, 100V	SMD 1206
C15	electrolytic capacitor	10 μ F, 100 V	SMD 2220
C16	electrolytic capacitor	10 nF, 200 V	SMD 1210
C17	electrolytic capacitor	470 μ F, 63 V	PCE3667CT-ND
E1, E2	drain voltage connection	-	
J1	RF in connector	-	
J2	RF out connector	-	
L1	inductor	330 nH	1008CS-331XJB
L2	ferrite bead	-	2743019447
L3	inductor	-	1 turn, 18 AWG, inner diameter = 4.06 mm
Q1	transistor	-	CLF1G0060-30
Q2	transistor	-	NXP BC857B
Q3	transistor	-	NXP PSMN8R2-80YS
R1	resistor	10 k Ω	Vishay Dale
R2	resistor	10 Ω	Vishay Dale
R3	resistor	0.005 Ω	RL7520WT-R005-F
Z1, Z2, Z3, Z4, Z5, Z6, Z7, Z8, Z9, Z10, Z11, Z12, Z13	microstrip lines	-	

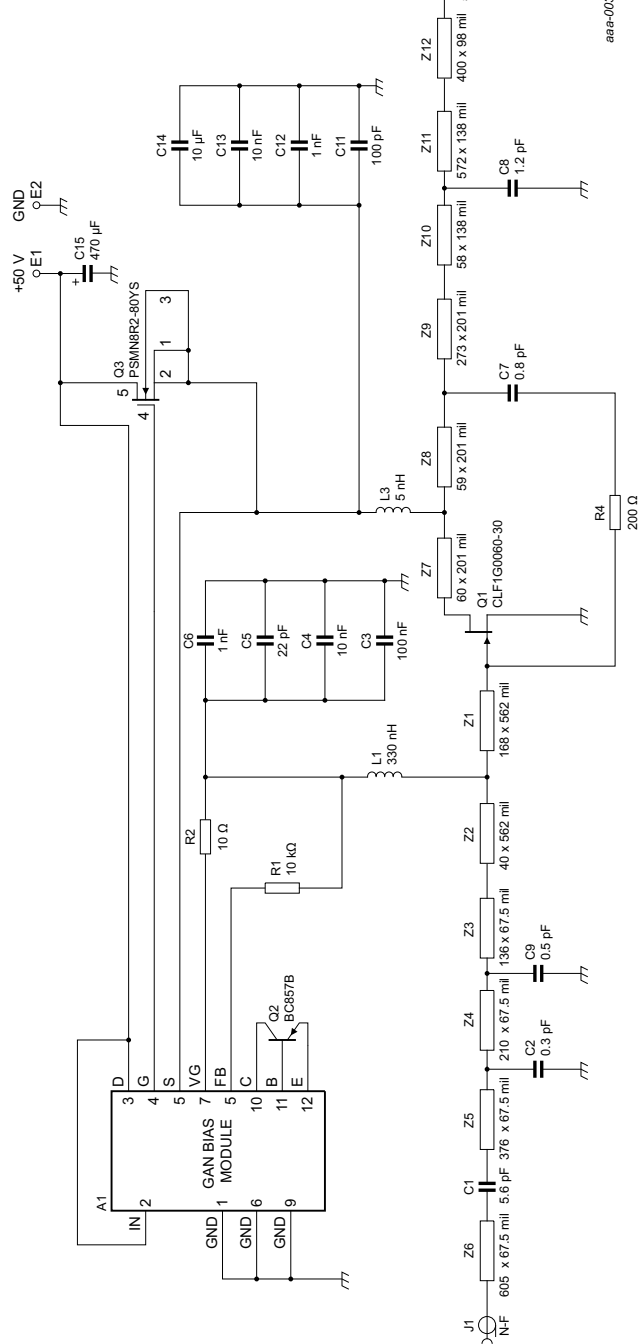

See [Table 9](#) for a list of components.

Fig 2. The broadband amplifier (500 MHz to 2500 MHz) demo circuit schematic

7.2 Application test results

Table 10. CW and pulsed RF application information

Typical RF performance at $T_{case} = 25\text{ }^{\circ}\text{C}$; $I_{Dq} = 70\text{ mA}$; $V_{DS} = 50\text{ V}$ in a class-AB broadband demo board.

Test signal	f	P _L	G _p	η _D
	(MHz)	(W)	(dB)	(%)
1-Tone CW	500	30	15.6	60.7
	1000	30	13.9	50.3
	1500	30	13.7	50.8
	2000	30	12.6	49
	2500	30	14.2	55.6
1-Tone pulsed [1]	500	30	16.6	61
	1000	30	15.8	50
	1500	30	15.5	52.5
	2000	30	14.5	50
	2500	30	15.9	59

[1] Pulsed RF; $t_p = 100\text{ }\mu\text{s}$; $\delta = 10\text{ }\%$.

Table 11. 2-Tone CW application information

Typical 2-Tone performance at $T_{case} = 25\text{ }^{\circ}\text{C}$; $I_{Dq} = 150\text{ mA}$; $V_{DS} = 50\text{ V}$ in a class-AB broadband demo board.

Test signal	f	P _{L(PEP)}	IMD3
	(MHz)	(W)	(dBc)
2-Tone CW [1]	500	10	-38
	1000	10	-50
	1500	10	-45
	2000	10	-50
	2500	10	-43

[1] 2-Tone CW; $\Delta f = 1\text{ MHz}$.

7.3 Graphical data

The following figures are measured in a broadband amplifier demo board from 500 MHz to 2500 MHz.

7.3.1 1-Tone CW RF performance

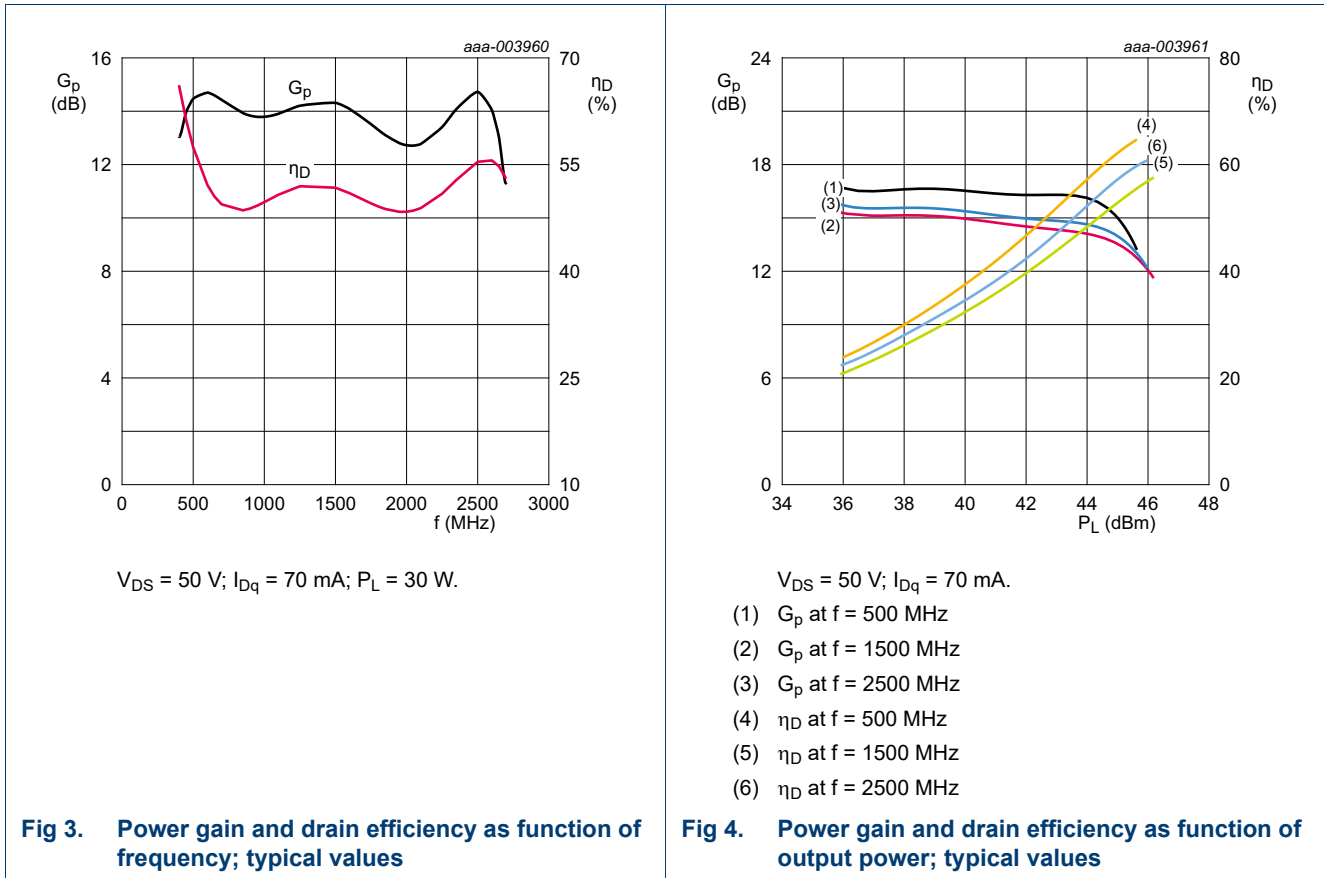

7.3.2 1-Tone pulsed RF performance

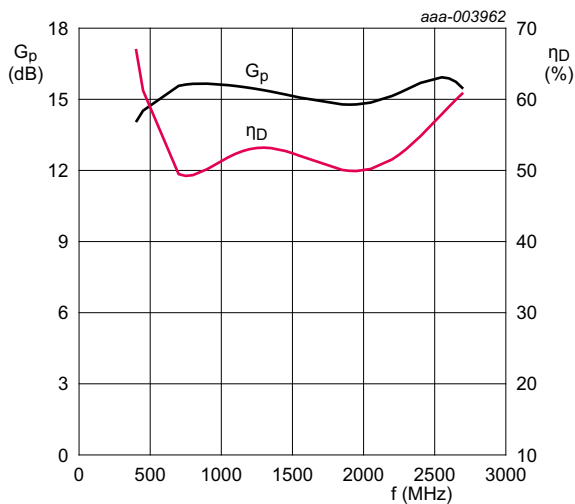

$V_{DS} = 50\text{ V}$; $I_{Dq} = 70\text{ mA}$; $P_L = 30\text{ W}$; $t_p = 100\ \mu\text{s}$;
 $\delta = 10\ \%$.

Fig 5. Power gain and drain efficiency as function of frequency; typical values

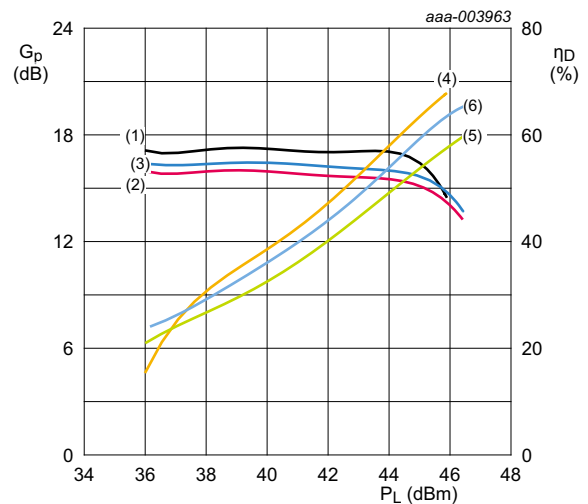

$V_{DS} = 50\text{ V}$; $I_{Dq} = 70\text{ mA}$; $t_p = 100\ \mu\text{s}$; $\delta = 10\ \%$.

- (1) G_p at $f = 500\text{ MHz}$
- (2) G_p at $f = 1500\text{ MHz}$
- (3) G_p at $f = 2500\text{ MHz}$
- (4) η_D at $f = 500\text{ MHz}$
- (5) η_D at $f = 1500\text{ MHz}$
- (6) η_D at $f = 2500\text{ MHz}$

Fig 6. Power gain and drain efficiency gain as function of output power; typical values

7.3.3 2-Tone CW performance

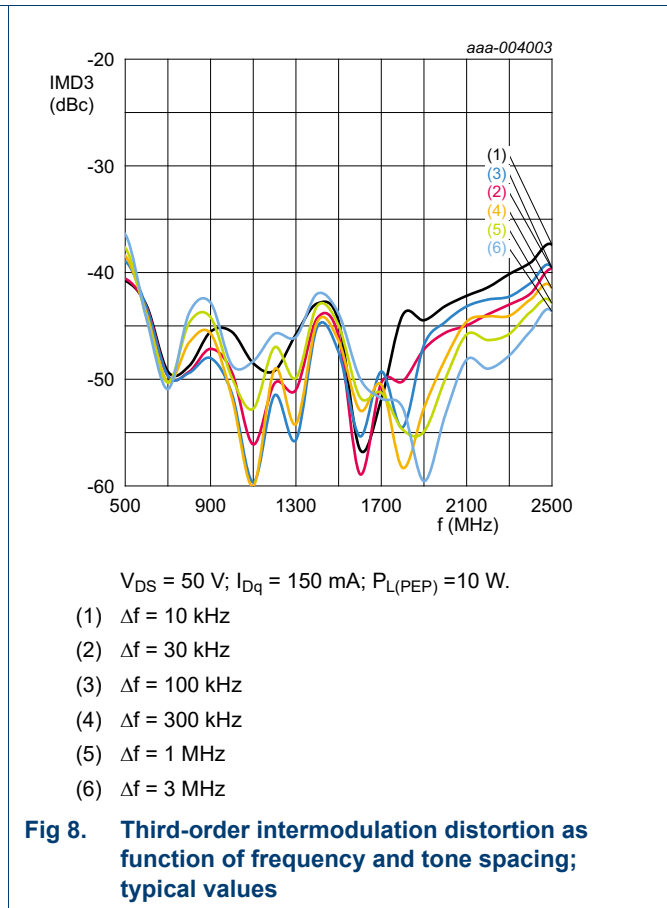
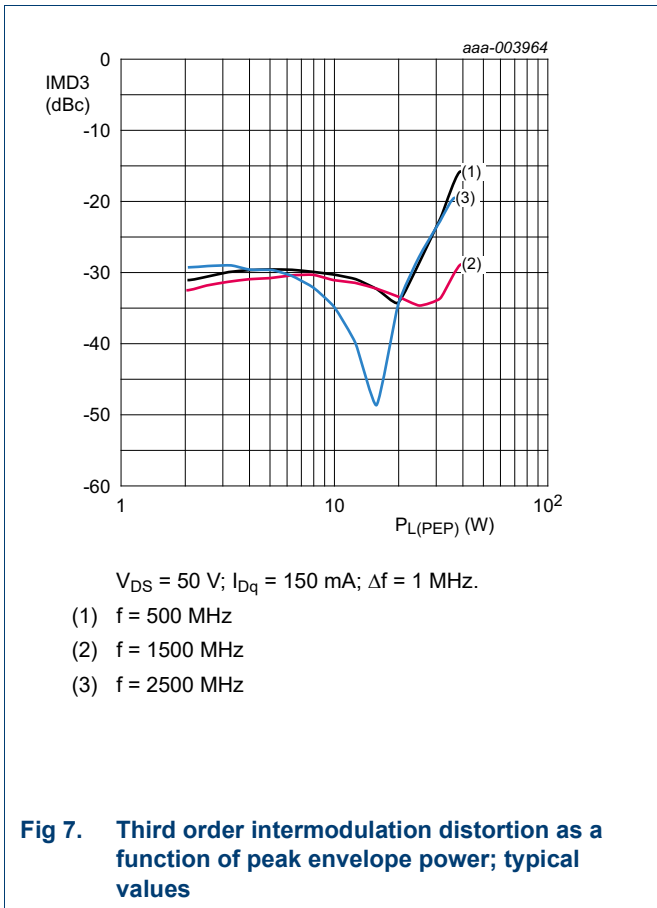

7.4 Bias module

The bias module information for the GaN HEMT amplifier is described in application note AN11130.

8. Test information

8.1 Ruggedness in class-AB operation

The CLF1G0060-30 and CLF1G0060S-30 are capable of withstanding a load mismatch corresponding to VSWR = 10 : 1 through all phases under the following conditions: $V_{DS} = 50 \text{ V}; P_L = 30 \text{ W}$ (pulsed RF), $f = 3000 \text{ MHz}.$

8.2 Load pull impedance information

The measured load pull impedances are shown below. Impedance reference plane defined at device leads. Measurements performed with Ampleon test fixtures. Test temperature set at 25 °C with a pulsed CW signal; $t_p = 100 \mu\text{s}; \delta = 10 \%;$ RF performance at $V_{DS} = 50 \text{ V}; I_{Dq} = 50 \text{ mA}.$

Table 12. Typical impedance
Typical values unless otherwise specified.

f (MHz)	Z _S (Ω)	Z _L (maximum P _{L(M)}) (Ω)	Z _L (maximum η _D) (Ω)
2140	1.4 – 4j	14 + 5.4j	12.5 + 9.7j
2500	2.8 – 6j	10.5 + 2.5j	7.6 + 5.6j
2700	2.8 – 7.5j	10.7 + 1.3j	7.6 + 4.3j
3000	3.0 – 10j	9.1 + 3.5j	7.7 + 4.2j
3300	3.0 – 11.5j	9.4 + 1.2j	7.6 + 2.5j
3500	3.0 – 13j	9.5	7.2 + 1.35j
3700	3.5 – 14.4j	9.4 – 1.1j	7.3 – 0.05j
4000	3.7 – 20.3j	9.3 – 2.4j	7.7 – 1.2j

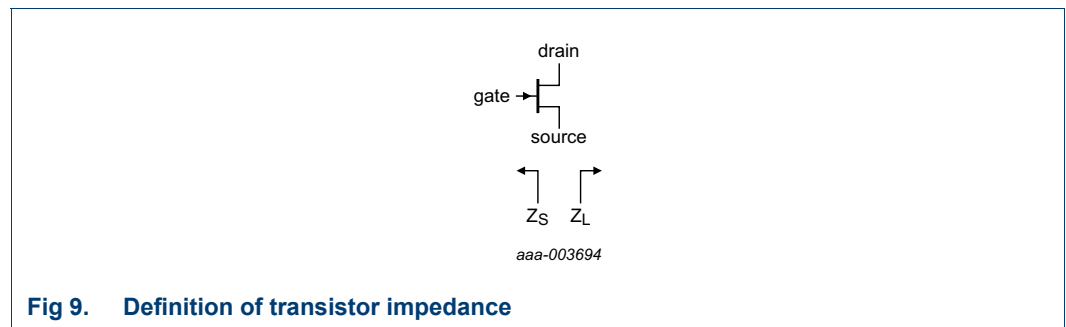

Fig 9. Definition of transistor impedance

Z_S is the measured source pull impedance presented to the device. Z_L is the measured load pull impedance presented to the device.

8.3 Packaged S-parameter data

Table 13. S-parameter

Small signal; $V_{DS} = 50\text{ V}$; $I_{Dq} = 50\text{ mA}$; $Z_S = Z_L = 50\ \Omega$.

f (MHz)	S ₁₁		S ₂₁		S ₁₂		S ₂₂	
	Magnitude (ratio)	Angle (degree)	Magnitude (ratio)	Angle (degree)	Magnitude (ratio)	Angle (degree)	Magnitude (ratio)	Angle (degree)
100	0.9302	-76.396	44.515	135.22	0.016195	46.871	0.7376	-43.407
200	0.87436	-115.47	29.415	111.96	0.021253	25.279	0.55438	-65.523
300	0.8537	-134.97	21.02	98.876	0.022516	13.903	0.47582	-77.762
400	0.8464	-146.22	16.096	89.855	0.02261	6.6529	0.44954	-86.181
500	0.8446	-153.57	12.919	82.761	0.022198	1.4192	0.44849	-92.826
600	0.84548	-158.81	10.71	76.739	0.021498	-2.6237	0.46041	-98.482
700	0.84785	-162.82	9.0883	71.392	0.020604	-5.8352	0.47921	-103.5
800	0.85112	-166.05	7.8465	66.516	0.019567	-8.375	0.50159	-108.06
900	0.85494	-168.77	6.8655	61.995	0.018424	-10.302	0.5256	-112.27
1000	0.85908	-171.15	6.0713	57.758	0.017205	-11.612	0.5501	-116.19
1100	0.86338	-173.27	5.4157	53.759	0.015936	-12.256	0.57433	-119.86
1200	0.86774	-175.22	4.866	49.966	0.014644	-12.138	0.59785	-123.33
1300	0.87206	-177.04	4.3993	46.356	0.01336	-11.113	0.62038	-126.6
1400	0.8763	-178.75	3.9988	42.911	0.012117	-8.9845	0.64176	-129.7
1500	0.88039	179.61	3.6521	39.616	0.010958	-5.505	0.66191	-132.65
1600	0.88432	178.03	3.3496	36.459	0.0099386	-0.40868	0.68081	-135.46
1700	0.88806	176.49	3.0841	33.428	0.0091267	6.4893	0.69846	-138.14
1800	0.8916	175	2.8497	30.514	0.0085991	15.099	0.7149	-140.7
1900	0.89493	173.53	2.6416	27.709	0.008424	24.853	0.73019	-143.15
2000	0.89806	172.09	2.4562	25.005	0.0086339	34.74	0.74438	-145.5
2100	0.90098	170.67	2.2902	22.395	0.0092114	43.73	0.75755	-147.76
2200	0.9037	169.26	2.1411	19.872	0.0101	51.208	0.76975	-149.93
2300	0.90622	167.87	2.0067	17.429	0.011233	57.053	0.78106	-152.02
2400	0.90856	166.48	1.8852	15.062	0.012549	61.439	0.79154	-154.04
2500	0.91072	165.11	1.775	12.766	0.014001	64.635	0.80125	-155.99
2600	0.91272	163.74	1.6748	10.534	0.015556	66.902	0.81025	-157.88
2700	0.91455	162.37	1.5835	8.3639	0.017191	68.455	0.8186	-159.71
2800	0.91623	161	1.5001	6.2502	0.01889	69.459	0.82634	-161.49
2900	0.91777	159.63	1.4237	4.1894	0.020642	70.039	0.83353	-163.22
3000	0.91917	158.27	1.3535	2.1779	0.022441	70.288	0.8402	-164.91
3100	0.92044	156.89	1.289	0.21252	0.024281	70.278	0.84641	-166.55
3200	0.9216	155.52	1.2296	-1.71	0.02616	70.06	0.85218	-168.16
3300	0.92264	154.14	1.1748	-3.5925	0.028076	69.675	0.85755	-169.73
3400	0.92357	152.75	1.1241	-5.4376	0.030027	69.154	0.86255	-171.27
3500	0.92441	151.35	1.0771	-7.2479	0.032015	68.521	0.8672	-172.78
3600	0.92515	149.94	1.0336	-9.0257	0.034039	67.795	0.87155	-174.26
3700	0.92579	148.53	0.99314	-10.773	0.036099	66.989	0.87559	-175.72

Table 13. S-parameter ...continued

Small signal; $V_{DS} = 50\text{ V}$; $I_{Dq} = 50\text{ mA}$; $Z_S = Z_L = 50\ \Omega$.

f (MHz)	S ₁₁		S ₂₁		S ₁₂		S ₂₂	
	Magnitude (ratio)	Angle (degree)	Magnitude (ratio)	Angle (degree)	Magnitude (ratio)	Angle (degree)	Magnitude (ratio)	Angle (degree)
3800	0.92635	147.1	0.95551	-12.493	0.038198	66.115	0.87937	-177.15
3900	0.92683	145.65	0.92046	-14.186	0.040336	65.183	0.8829	-178.57
4000	0.92723	144.2	0.88777	-15.855	0.042516	64.2	0.88619	-179.97
4100	0.92756	142.73	0.85724	-17.501	0.044737	63.171	0.88927	178.65
4200	0.92781	141.24	0.82871	-19.126	0.047003	62.101	0.89215	177.28
4300	0.928	139.73	0.802	-20.732	0.049315	60.994	0.89484	175.93
4400	0.92812	138.2	0.77698	-22.32	0.051676	59.853	0.89735	174.58
4500	0.92818	136.66	0.75351	-23.891	0.054087	58.68	0.8997	173.25
4600	0.92818	135.09	0.73149	-25.447	0.05655	57.477	0.9019	171.92
4700	0.92812	133.5	0.71079	-26.99	0.059068	56.245	0.90396	170.6
4800	0.928	131.89	0.69133	-28.519	0.061644	54.986	0.90588	169.28
4900	0.92783	130.25	0.67301	-30.038	0.064279	53.699	0.90767	167.97
5000	0.92761	128.59	0.65576	-31.546	0.066975	52.387	0.90935	166.66
5100	0.92734	126.9	0.63949	-33.046	0.069736	51.047	0.91092	165.35
5200	0.92701	125.17	0.62415	-34.537	0.072563	49.682	0.91238	164.04
5300	0.92664	123.42	0.60968	-36.022	0.075459	48.291	0.91375	162.73
5400	0.92622	121.64	0.596	-37.501	0.078426	46.874	0.91502	161.42
5500	0.92576	119.83	0.58307	-38.975	0.081467	45.43	0.9162	160.1
5600	0.92525	117.98	0.57085	-40.446	0.084583	43.959	0.9173	158.78
5700	0.9247	116.1	0.55929	-41.914	0.087778	42.461	0.91832	157.45
5800	0.92411	114.18	0.54834	-43.38	0.091053	40.935	0.91927	156.12
5900	0.92348	112.22	0.53797	-44.846	0.094411	39.381	0.92014	154.77
6000	0.92282	110.23	0.52814	-46.311	0.097853	37.797	0.92095	153.42

9. Package outline

Flanged ceramic package; 2 mounting holes; 2 leads

SOT1227A

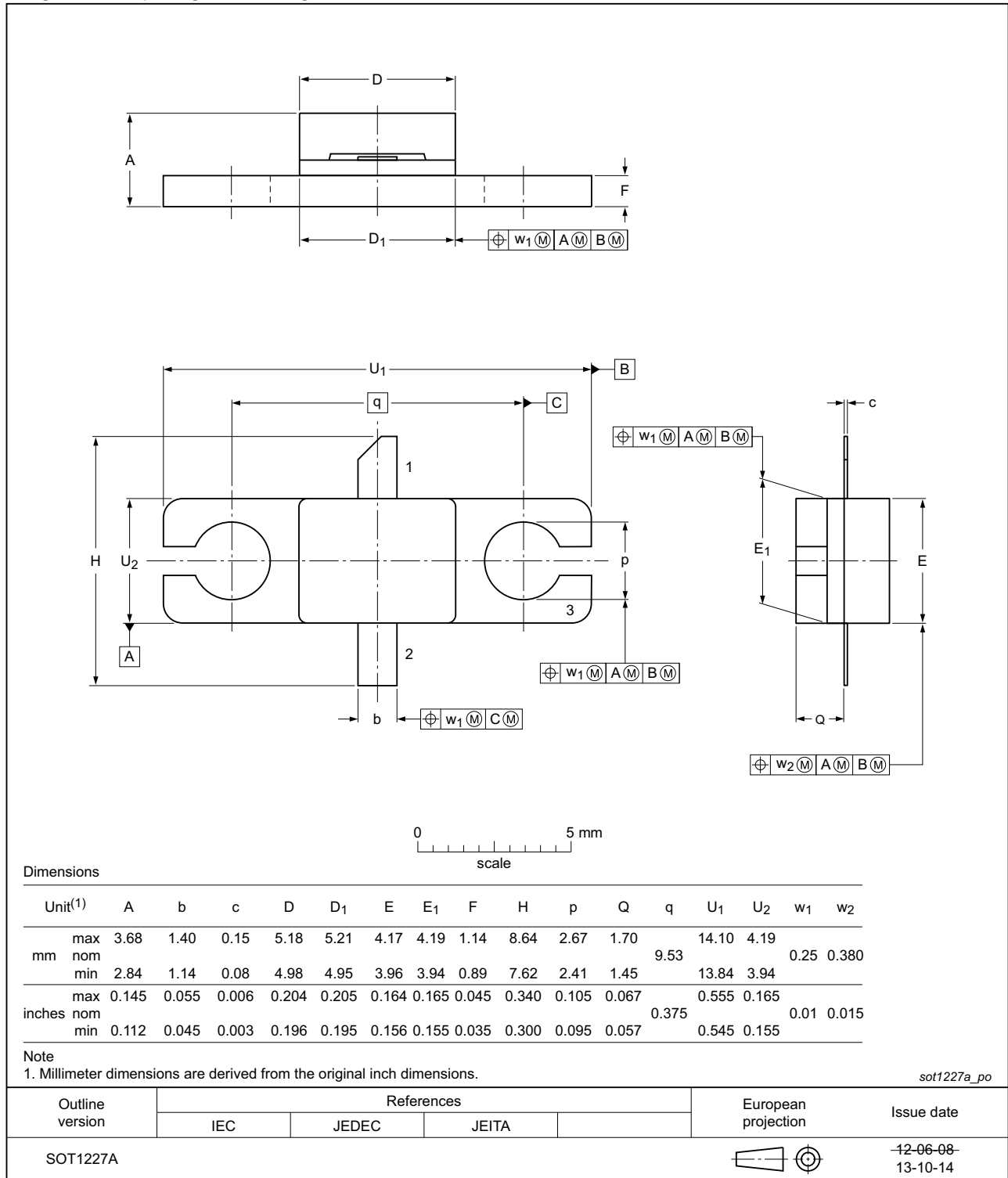

Fig 10. Package outline SOT1227A

Earless Flanged ceramic package; 2 leads

SOT1227B

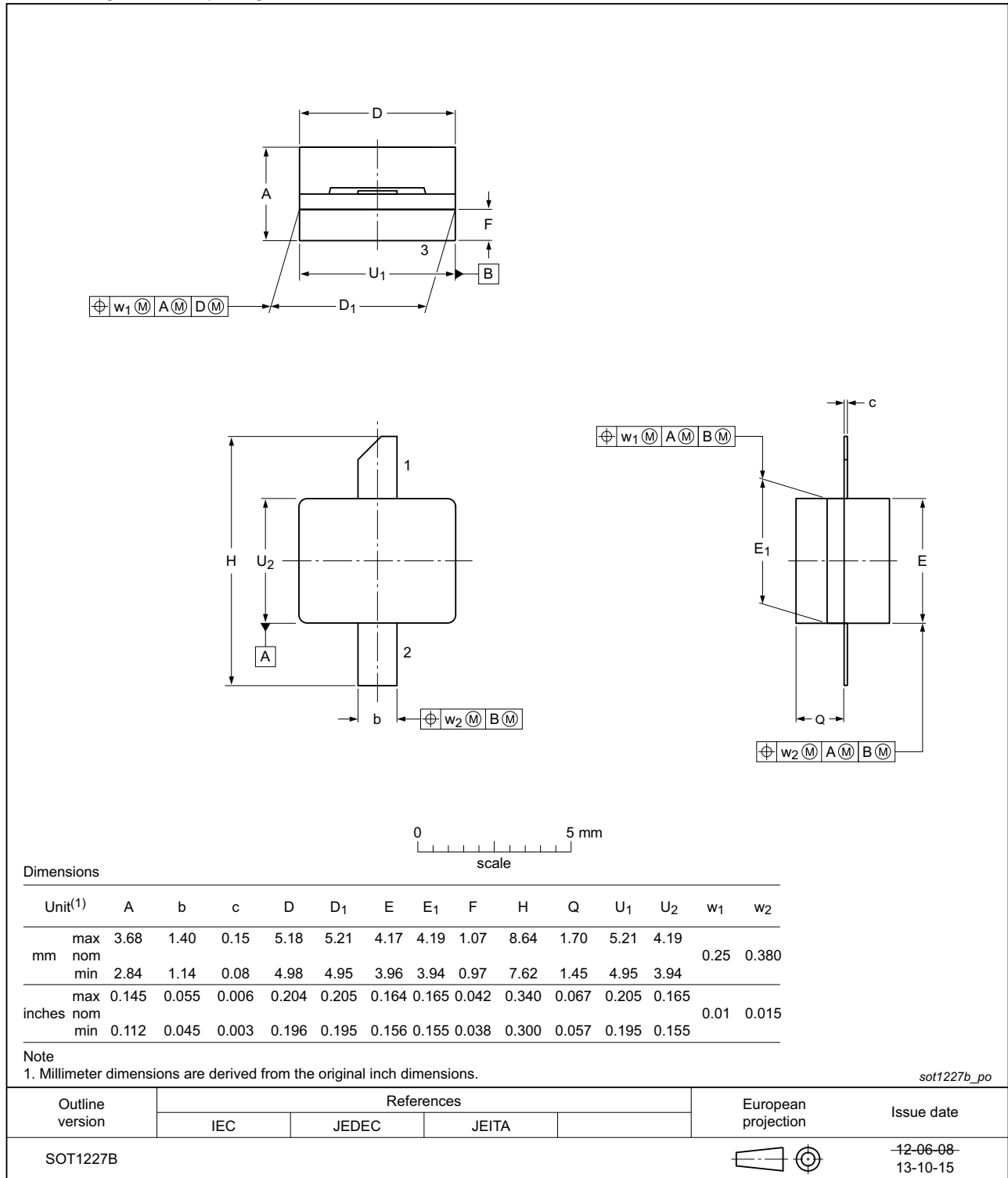

Fig 11. Package outline SOT1227B

10. Handling information

10.1 ESD Sensitivity

Table 14. ESD sensitivity

ESD model	Class
Human Body Model (HBM); According JEDEC standard JESD22-A114F	1B [1]

[1] Classification 1B is granted to any part that passes after exposure to an ESD pulse of 500 V, but fails after exposure to an ESD pulse of 1000 V.

11. Abbreviations

Table 15. Abbreviations

Acronym	Description
AWG	American Wire Gauge
CW	Continuous Wave
EMC	ElectroMagnetic Compatibility
ESD	ElectroStatic Discharge
GaN	Gallium Nitride
HEMT	High Electron Mobility Transistor
SMD	Surface Mounted Device
VSWR	Voltage Standing-Wave Ratio
WiMAX	Worldwide Interoperability for Microwave Access

12. Revision history

Table 16. Revision history

Document ID	Release date	Data sheet status	Change notice	Supersedes
CLF1G0060-30_1G0060S-30 v.7	20180205	Product data sheet	-	CLF1G0060-30_1G0060S-30 v.6
Modifications:	<ul style="list-style-type: none"> Table 9 on page 4: L1 remark updated Figure 2 on page 6: L1 value updated 			
CLF1G0060-30_1G0060S-30 v.6	20160218	Product data sheet	-	CLF1G0060-30_1G0060S-30#5
CLF1G0060-30_1G0060S-30#5	20150901	Objective data sheet	-	CLF1G0060-30_1G0060S-30 v.4
CLF1G0060-30_1G0060S-30 v.4	20130620	Objective data sheet	-	CLF1G0060-30_1G0060S-30 v.3
CLF1G0060-30_1G0060S-30 v.3	20130327	Objective data sheet	-	CLF1G0060-30_1G0060S-30 v.2
CLF1G0060-30_1G0060S-30 v.2	20130129	Objective data sheet	-	CLF1G0060-30_1G0060S-30 v.1
CLF1G0060-30_1G0060S-30 v.1	20121008	Objective data sheet	-	-

13. Legal information

13.1 Data sheet status

Document status ^{[1][2]}	Product status ^[3]	Definition
Objective [short] data sheet	Development	This document contains data from the objective specification for product development.
Preliminary [short] data sheet	Qualification	This document contains data from the preliminary specification.
Product [short] data sheet	Production	This document contains the product specification.

[1] Please consult the most recently issued document before initiating or completing a design.

[2] The term 'short data sheet' is explained in section "Definitions".

[3] The product status of device(s) described in this document may have changed since this document was published and may differ in case of multiple devices. The latest product status information is available on the Internet at URL <http://www.ampleon.com>.

13.2 Definitions

Draft — The document is a draft version only. The content is still under internal review and subject to formal approval, which may result in modifications or additions. Ampleon does not give any representations or warranties as to the accuracy or completeness of information included herein and shall have no liability for the consequences of use of such information.

Short data sheet — A short data sheet is an extract from a full data sheet with the same product type number(s) and title. A short data sheet is intended for quick reference only and should not be relied upon to contain detailed and full information. For detailed and full information see the relevant full data sheet, which is available on request via the local Ampleon sales office. In case of any inconsistency or conflict with the short data sheet, the full data sheet shall prevail.

Product specification — The information and data provided in a Product data sheet shall define the specification of the product as agreed between Ampleon and its customer, unless Ampleon and customer have explicitly agreed otherwise in writing. In no event however, shall an agreement be valid in which the Ampleon product is deemed to offer functions and qualities beyond those described in the Product data sheet.

13.3 Disclaimers

Limited warranty and liability — Information in this document is believed to be accurate and reliable. However, Ampleon does not give any representations or warranties, expressed or implied, as to the accuracy or completeness of such information and shall have no liability for the consequences of use of such information. Ampleon takes no responsibility for the content in this document if provided by an information source outside of Ampleon.

In no event shall Ampleon be liable for any indirect, incidental, punitive, special or consequential damages (including - without limitation - lost profits, lost savings, business interruption, costs related to the removal or replacement of any products or rework charges) whether or not such damages are based on tort (including negligence), warranty, breach of contract or any other legal theory.

Notwithstanding any damages that customer might incur for any reason whatsoever, Ampleon's aggregate and cumulative liability towards customer for the products described herein shall be limited in accordance with the *Terms and conditions of commercial sale* of Ampleon.

Right to make changes — Ampleon reserves the right to make changes to information published in this document, including without limitation specifications and product descriptions, at any time and without notice. This document supersedes and replaces all information supplied prior to the publication hereof.

Suitability for use — Ampleon products are not designed, authorized or warranted to be suitable for use in life support, life-critical or safety-critical systems or equipment, nor in applications where failure or malfunction of an

Ampleon product can reasonably be expected to result in personal injury, death or severe property or environmental damage. Ampleon and its suppliers accept no liability for inclusion and/or use of Ampleon products in such equipment or applications and therefore such inclusion and/or use is at the customer's own risk.

Applications — Applications that are described herein for any of these products are for illustrative purposes only. Ampleon makes no representation or warranty that such applications will be suitable for the specified use without further testing or modification.

Customers are responsible for the design and operation of their applications and products using Ampleon products, and Ampleon accepts no liability for any assistance with applications or customer product design. It is customer's sole responsibility to determine whether the Ampleon product is suitable and fit for the customer's applications and products planned, as well as for the planned application and use of customer's third party customer(s). Customers should provide appropriate design and operating safeguards to minimize the risks associated with their applications and products.

Ampleon does not accept any liability related to any default, damage, costs or problem which is based on any weakness or default in the customer's applications or products, or the application or use by customer's third party customer(s). Customer is responsible for doing all necessary testing for the customer's applications and products using Ampleon products in order to avoid a default of the applications and the products or of the application or use by customer's third party customer(s). Ampleon does not accept any liability in this respect.

Limiting values — Stress above one or more limiting values (as defined in the Absolute Maximum Ratings System of IEC 60134) will cause permanent damage to the device. Limiting values are stress ratings only and (proper) operation of the device at these or any other conditions above those given in the Recommended operating conditions section (if present) or the Characteristics sections of this document is not warranted. Constant or repeated exposure to limiting values will permanently and irreversibly affect the quality and reliability of the device.

Terms and conditions of commercial sale — Ampleon products are sold subject to the general terms and conditions of commercial sale, as published at <http://www.ampleon.com/terms>, unless otherwise agreed in a valid written individual agreement. In case an individual agreement is concluded only the terms and conditions of the respective agreement shall apply. Ampleon hereby expressly objects to applying the customer's general terms and conditions with regard to the purchase of Ampleon products by customer.

No offer to sell or license — Nothing in this document may be interpreted or construed as an offer to sell products that is open for acceptance or the grant, conveyance or implication of any license under any copyrights, patents or other industrial or intellectual property rights.

Export control — This document as well as the item(s) described herein may be subject to export control regulations. Export might require a prior authorization from competent authorities.

Non-automotive qualified products — Unless this data sheet expressly states that this specific Ampleon product is automotive qualified, the product is not suitable for automotive use. It is neither qualified nor tested in accordance with automotive testing or application requirements. Ampleon accepts no liability for inclusion and/or use of non-automotive qualified products in automotive equipment or applications.

In the event that customer uses the product for design-in and use in automotive applications to automotive specifications and standards, customer (a) shall use the product without Ampleon's warranty of the product for such automotive applications, use and specifications, and (b) whenever customer uses the product for automotive applications beyond Ampleon's specifications such use shall be solely at customer's own risk, and (c) customer fully indemnifies Ampleon for any liability, damages or failed product claims resulting from customer design and use of the product for automotive applications beyond Ampleon's standard warranty and Ampleon's product specifications.

Translations — A non-English (translated) version of a document is for reference only. The English version shall prevail in case of any discrepancy between the translated and English versions.

13.4 Trademarks

Notice: All referenced brands, product names, service names and trademarks are the property of their respective owners.

Any reference or use of any 'NXP' trademark in this document or in or on the surface of Ampleon products does not result in any claim, liability or entitlement vis-à-vis the owner of this trademark. Ampleon is no longer part of the NXP group of companies and any reference to or use of the 'NXP' trademarks will be replaced by reference to or use of Ampleon's own trademarks.

14. Contact information

For more information, please visit: <http://www.ampleon.com>

For sales office addresses, please visit: <http://www.ampleon.com/sales>

15. Contents

1 Product profile 1

1.1 General description 1

1.2 Features and benefits 2

1.3 Applications 2

2 Pinning information 2

3 Ordering information 2

4 Limiting values 3

5 Thermal characteristics 3

6 Characteristics 3

7 Application information 4

7.1 Demo circuit 4

7.2 Application test results 7

7.3 Graphical data 8

7.3.1 1-Tone CW RF performance 8

7.3.2 1-Tone pulsed RF performance 9

7.3.3 2-Tone CW performance 10

7.4 Bias module 10

8 Test information 10

8.1 Ruggedness in class-AB operation 10

8.2 Load pull impedance information 10

8.3 Packaged S-parameter data 12

9 Package outline 14

10 Handling information 16

10.1 ESD Sensitivity 16

11 Abbreviations 16

12 Revision history 16

13 Legal information 17

13.1 Data sheet status 17

13.2 Definitions 17

13.3 Disclaimers 17

13.4 Trademarks 18

14 Contact information 18

15 Contents 19

Please be aware that important notices concerning this document and the product(s) described herein, have been included in section 'Legal information'.

© Ampleon Netherlands B.V. 2018. All rights reserved.



For more information, please visit: <http://www.ampleon.com>
 For sales office addresses, please visit: <http://www.ampleon.com/sales>

Date of release: 5 February 2018





Document identifier: CLF1G0060-30_1G0060S-30

Looking for pricing, stock, or lifecycle information?

Click below to explore more details on WIN SOURCE:

-  [View CLF1G0060-30U on WIN SOURCE](#)
-  [Ampleon USA Inc. Information](#)

Optimize Your Supply Chain with WIN SOURCE Solutions

-  Global Sourcing Solution
-  Obsolete Management
-  Cost Control Management
-  Shortage Management
-  Alternative Solution
-  Excess Inventory Management