



THE DATASHEET OF LDW25-24S



LDW25 Series

25 W Wide Input Range DIN Rail Power Supply

LDW25 Series are 25 W single- or two-phase wide input range DIN rail power supplies.

Its compact size, high efficiency, excellent reliability together with easy installation due to pluggable connectors makes it market leader for various industrial and renewable energy applications and applications with harsh main conditions.

LDW25 Series are Class II isolation devices designed to be mounted on DIN rail and installed inside a protective enclosure.

FEATURES

- Single or two or phase AC input 90 - 550 VAC or wide DC input voltage range 150 - 725 VDC
- Output voltages 12 V 24 V, 48 V (adjustable)
- Operating temperature range -40°C to +70°C with derating
- Overload 130%
- Compliant to renewable energy system and high voltage DC BUS
- Models with suffix S have conformal coating on PCB
- Class II insulation
- Simplified wiring (no PE connection)
- Compact size in plastic enclosure (circuit breaker shape)
- Dimensions: 72 x 114.2 x 61.5 mm

APPLICATIONS

- Industrial control and instrumentation equipment
- Renewable energy applications
- Harsh environment applications

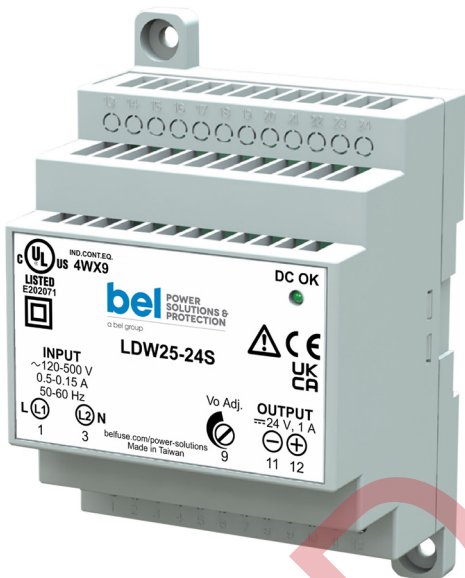

1. MODEL SELECTION

MODEL ¹	INPUT VOLTAGE RANGE	# OF PHASES	OUTPUT VOLTAGE	MAX OUTPUT CURRENT	EFFICIENCY	MAX OUTPUT POWER
LDW25-12 LDW25-12S	120 - 500 VAC (150 - 725 VDC)	1 / 2	12 V	2.0 - 1.6 A	81.5 %	25 W
LDW25-24 LDW25-24S	120 - 500 VAC (150 - 725 VDC)	1 / 2	24 V	1.0 A	84.5 %	25 W
LDW25-48 LDW25-48S	120 - 500 VAC (150 - 725 VDC)	1 / 2	48 V	0.5 A	84 %	25 W

¹ Models with suffix S have conformal coating on PC-Board. For models without suffix S consult factory.

2. INPUT SPECIFICATIONS

PARAMETER	DESCRIPTION / CONDITIONS	SPECIFICATION
AC Input Voltage	Nominal 1 / 2 phases Range	120 - 500 VAC 90 - 550 VAC
DC Input Voltage	Range	150 - 725 VDC
Input Frequency		47 - 63 Hz
AC Input Current	V _{in} = 120 VAC Single phase	0.50 A
	V _{in} = 500 VAC Two phase	0.15 A
DC Input Current	V _{in} = 150 VDC	0.30 A
	V _{in} = 725 VDC	< 0.10 A
Inrush Peak Current I _{pt}	Peak Current measured after 0.2 ms from main connection; 400 VAC / 50 Hz; T _a = 25°C; Cold Start	≤ 17 A 0.10 A ² s
Touch (Leakage) Current		≤ 0.2 mA
Internal Protection Fuse	None, external fuse must be provided	
Recommended External Protection ²	It is strongly recommended to provide external surge arresters (SPD) according to local regulations.	MCB 2 A C curve or Cartridge fuse Class CC 2 AT 600 VAC

² In order to be UL compliant use Listed Cartridge non-renewable (JDDZ) fuse Class CC 2 AT 600 VAC.

3. OUTPUT SPECIFICATIONS

PARAMETER	DESCRIPTION / CONDITIONS	SPECIFICATION
Output Voltage (Adjustable)	12 V model	12 - 15 VDC
	24 V model	23 - 28 VDC
	48 V model	45 - 55 VDC
Output Current (Continuous)	12 V model	2.0 - 1.6 A
	24 V model	1.0 A
	48 V model	0.5 A
Load Regulation		≤ 0.5 %
Ripple & Noise ³		≤ 50 mVpp
Hold-up Time	V _{in} = 240 VAC	≥ 35 ms
	V _{in} = 500 VAC	≥ 180 ms
Status Signals	DC OK - green LED	
Parallel Connection	Possible for redundancy (with external ORing module)	

³ Ripple and Noise are measured with 20 MHz bandwidth, probe terminated with a 0.1 μF MKP parallel capacitor.

4. PROTECTIONS

PARAMETER	DESCRIPTION / CONDITIONS	SPECIFICATION	
Short Circuit Protection	Hiccup mode, Short Circuit Peak Current:	12 V model	6.5 A
		24 V model	4.0 A
		48 V model	2.5 A
Overload Protection	Hiccup mode, Overload Limit ⁴ :	Vin = 120 VAC 12 V model	2.65 A
		24 V model	1.45 A
		48 V model	0.75 A
	Vin = 240/400/500 VAC	12 V model	2.9 A
		24 V model	1.7 A
		48 V model	0.9 A
Thermal Protection			
Over Voltage Protection		12 V model	≥ 18 VDC
		24 V model	≥ 33 VDC
		48 V model	≥ 68 VDC

⁴ On LDW25-12S measures are performed with output set to 12 VDC.

5. ENVIRONMENTAL, EMC & SAFETY SPECIFICATIONS

PARAMETER	DESCRIPTION / CONDITIONS	SPECIFICATION
Operating Temperature	Start-up type tested: - 40°C, possible at Vnom with load deration.	-40 to +70 °C
Storage Temperature		-40 to +80 °C
Derating	See derating curves (<i>Figure 1.</i> and <i>Figure 2.</i>)	
Dissipated Power	12 V model	< 5.5 W
	24 V model	< 4.5 W
	48 V model	< 4.6 W
Humidity	Non-condescending	5 - 95 % RH
Life Time Expectancy	Ta = 25°C, full load	179 477 (20.4) hrs (years)
MTBF	MIL-HDBK-217F at Ta = 25°C, full load	> 600 000 hrs
Overvoltage Category	EN 50178	III
Pollution Degree	IEC 60664-1	2
Protection Class	Class II	
Isolation	Input to Output	4.2 kVDC
Safety Standards & Approvals	UL 508 (certified) IEC/EN 61010-1 IEC/EN 61010-2-201 IEC/EN 60950	
EMC Emissions	EN 55011 / CISPR 11	Class B
	EN 55022 / CISPR 22	Class B
EMC Immunity	EN 61000-4-2	Level 3
	EN 61000-4-3	Level 3
	EN 61000-4-4	Level 3
	EN 61000-4-5	Level 4
	EN 61000-4-11	Level 2
Protection Degree	EN 60529	IP20
Vibration Sinusoidal	IEC 60068-2-6	5 - 17.8 Hz: ±1.6 mm; 17.8 - 500 Hz: 2 g 2 hours / axis (X, Y, Z)
Shock	IEC 60068-2-27	30 g 6 ms, 20 g 11 ms; 3 bumps / direction, 18 bumps total

6. DERATING CURVES

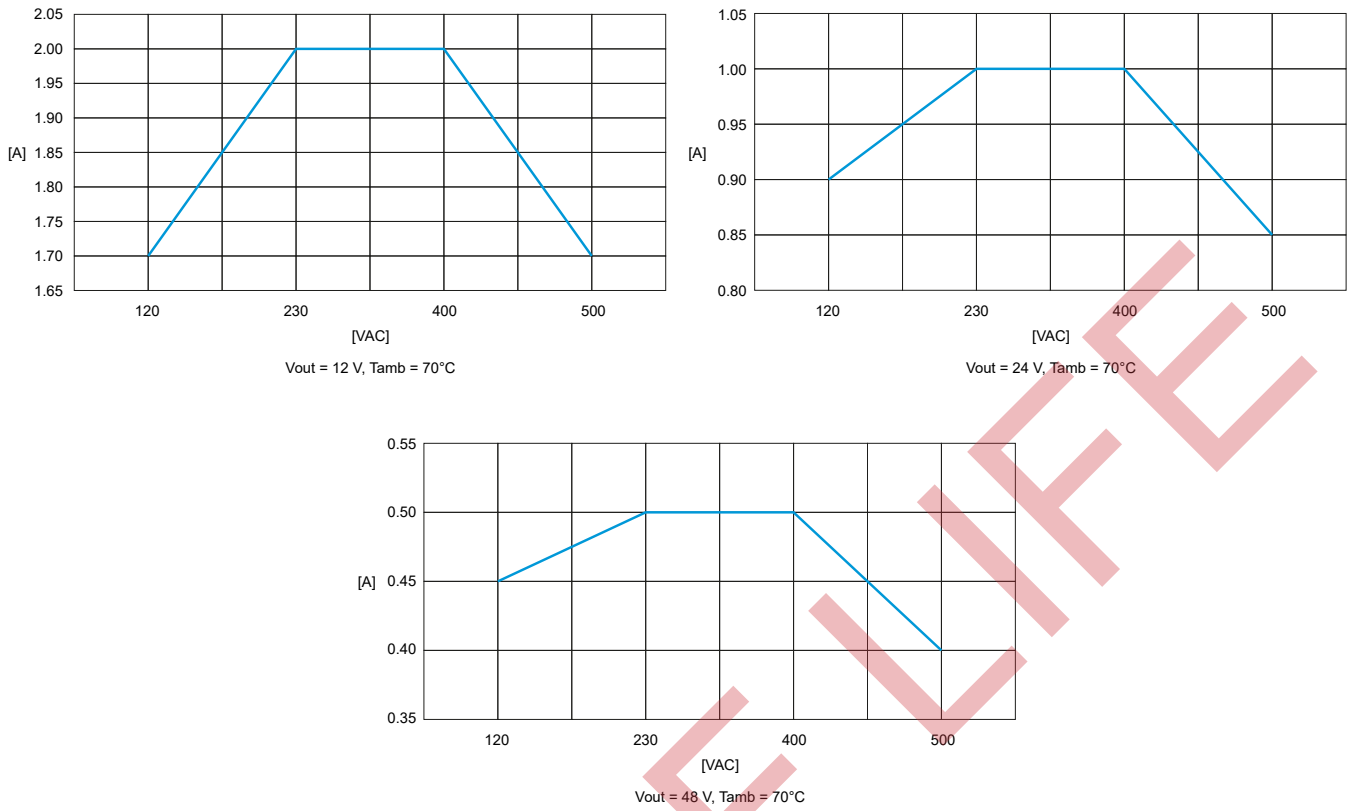

Figure 1. Input voltage vs Output current derating

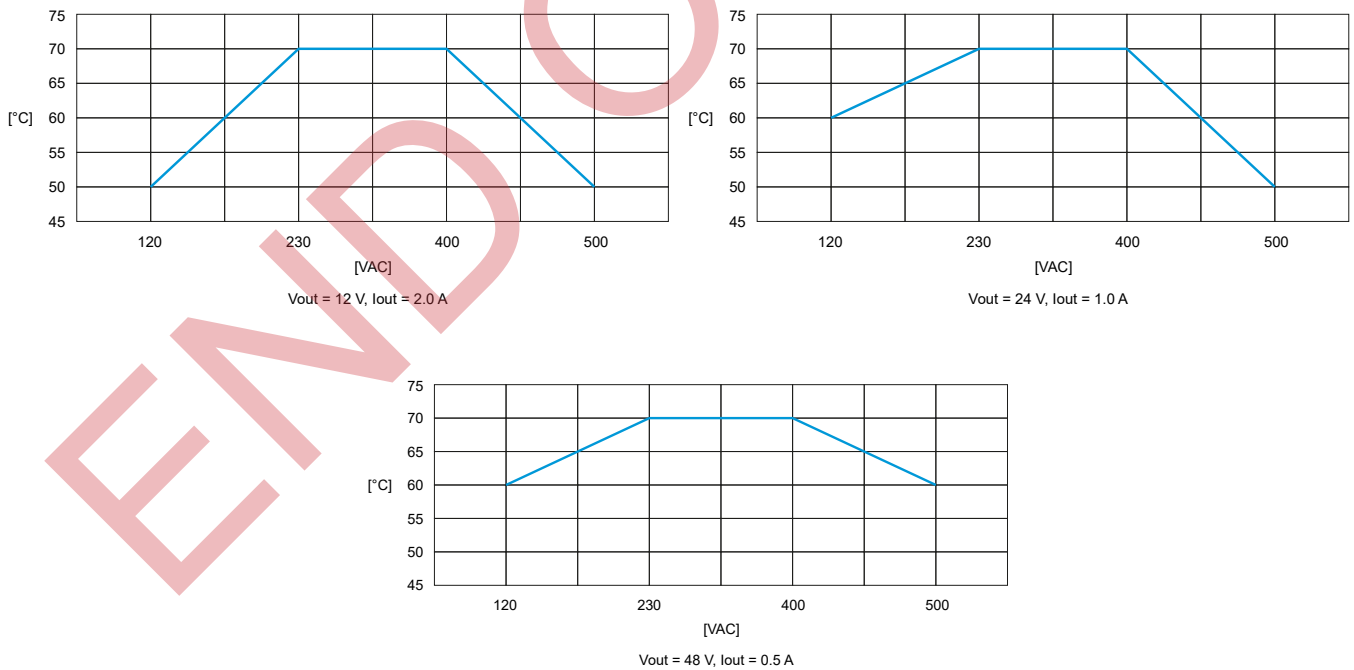
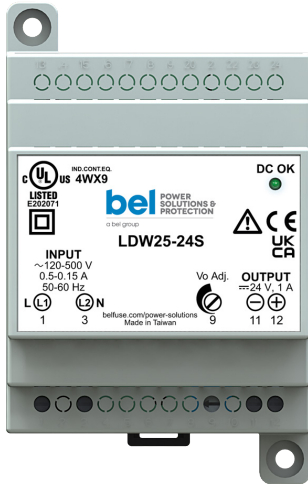

Figure 1. Input voltage vs Temperature derating

7. MECHANICAL SPECIFICATIONS

PARAMETER	DESCRIPTION / CONDITIONS	SPECIFICATION
Dimensions		72 x 114.2 x 61.5 mm 2.83 x 4.5 x 2.42 in
Weight		170 g
Mounting Rail	IEC 60715/H15/TH35-7.5(-15)	
Connection Terminals	Screw type pluggable (24 - 12 AWG)	2.5 mm ²
Case Material	Aluminum	

8. PIN LAYOUT & DESCRIPTION



PIN	DESCRIPTION
1, 3	AC/DC input
11, 12	DC output (load)
9	Output voltage adjustment
Green LED: Output OK	

INPUT CONNECTION	Single-phase	Two-phase	DC Input
	L = Line (1) N = Neutral (3)	L1 = Phase 1 (1) L2 = Phase 2 (3)	L (L1) = + Positive DC (1) N (L2) = - Negative DC (3)

OUTPUT CONNECTION	+ = Positive DC (12) - = Negative DC (11)
--------------------------	--

9. MECHANICAL DRAWING

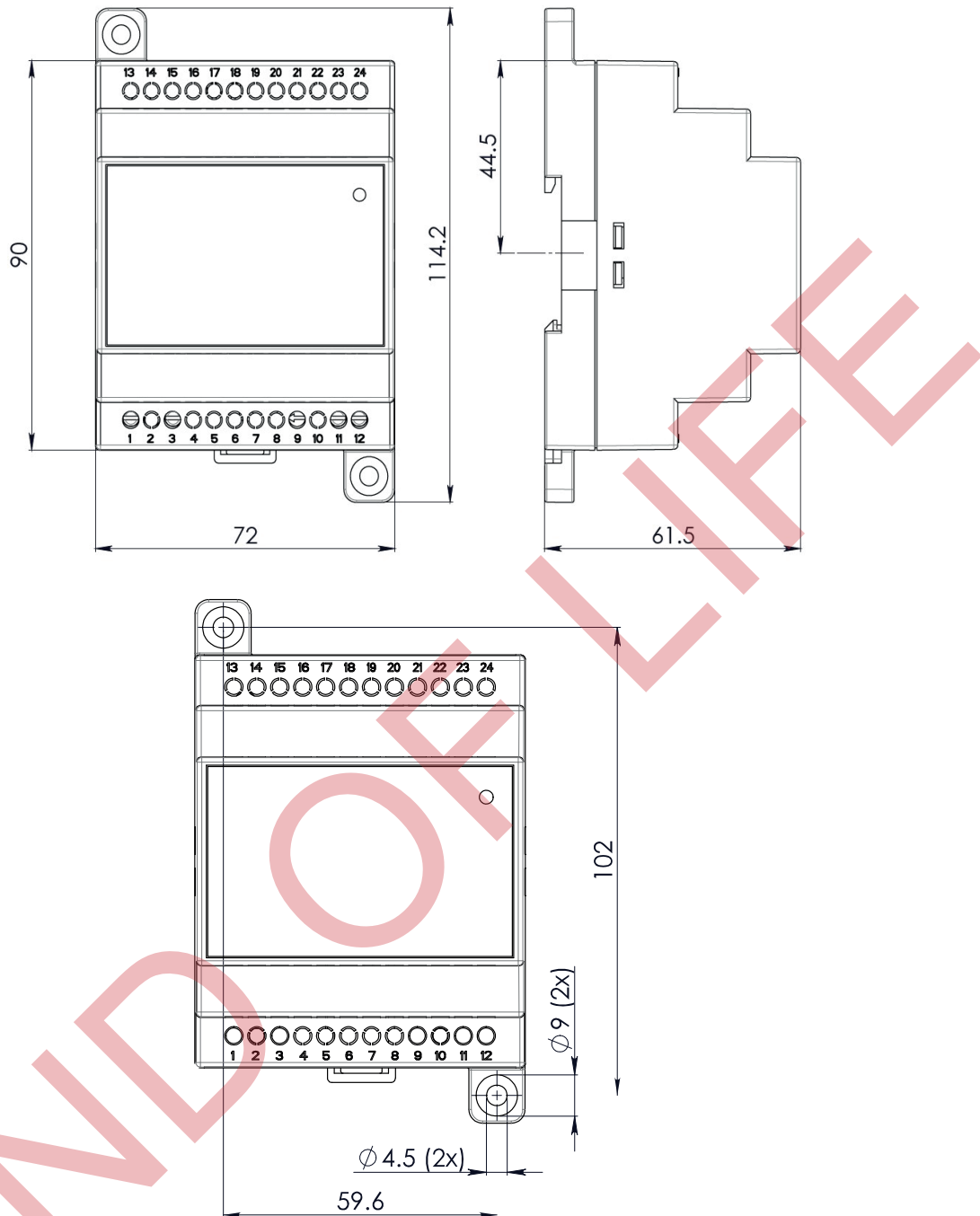

Figure 1. Mechanical Drawing

Notes:



Technical parameters are typical, measured in laboratory environment at 25°C and 240 VAC / 50 Hz, at nominal values, after minimum 5 minutes of operation. Power rating, losses, efficiency, ripple, thermal behaviour and start-up may change outside of the nominal rated input range. Contact factory for details.

NUCLEAR AND MEDICAL APPLICATIONS - Products are not designed or intended for use as critical components in life support systems, equipment used in hazardous environments, or nuclear control systems.

TECHNICAL REVISIONS - The appearance of products, including safety agency certifications pictured on labels, may change depending on the date manufactured. Specifications are subject to change without notice.

Looking for pricing, stock, or lifecycle information?

Click below to explore more details on WIN SOURCE:

-  [View LDW25-24S on WIN SOURCE](#)
-  [Bel Power Solutions Information](#)

Optimize Your Supply Chain with WIN SOURCE Solutions

-  Global Sourcing Solution
-  Obsolete Management
-  Cost Control Management
-  Shortage Management
-  Alternative Solution
-  Excess Inventory Management