

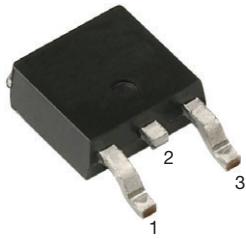

**THE DATASHEET OF
VS-10WQ045FNTRLHM3**



High Performance Schottky Rectifier, 10 A



DPAK (TO-252AA)

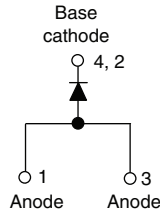

FEATURES

- Low forward voltage drop
- Guard ring for enhanced ruggedness and long term reliability
- Popular DPAK (TO-252AA) outline
- Small foot print, surface mountable
- High frequency operation
- AEC-Q101 qualified
- Meets JESD 201 class 2 whisker test
- Meets MSL level 1, per J-STD-020, LF maximum peak of 260 °C
- Material categorization: for definitions of compliance please see www.vishay.com/doc?99912

RoHS
 COMPLIANT
 HALOGEN
FREE

DESCRIPTION

The VS-10WQ045FNHM3 surface mount Schottky rectifier has been designed for applications requiring low forward drop and small foot prints on PC board. Typical applications are in disk drives, switching power supplies, converters, freewheeling diodes, battery charging, and reverse battery protection.

PRIMARY CHARACTERISTICS

$I_{F(AV)}$	10 A
V_R	45 V
V_F at I_F	0.53 V
I_{RM}	15 mA at 125 °C
T_J max.	175 °C
E_{AS}	20 mJ
Package	DPAK (TO-252AA)
Circuit configuration	Single

MAJOR RATINGS AND CHARACTERISTICS

SYMBOL	CHARACTERISTICS	VALUES	UNITS
$I_{F(AV)}$	Rectangular waveform	10	A
V_{RRM}		45	V
I_{FSM}	$t_p = 5 \mu s$ sine	400	A
V_F	10 A _{pk} , $T_J = 125$ °C	0.53	V
T_J	Range	-40 to +175	°C

VOLTAGE RATINGS

PARAMETER	SYMBOL	VS-10WQ045FNHM3	UNITS
Maximum DC reverse voltage	V_R	45	V
Maximum working peak reverse voltage	V_{RWM}		

ABSOLUTE MAXIMUM RATINGS

PARAMETER	SYMBOL	TEST CONDITIONS	VALUES	UNITS
Maximum average forward current See fig. 5	$I_{F(AV)}$	50 % duty cycle at $T_C = 157$ °C, rectangular waveform	10	A
Maximum peak one cycle non-repetitive surge current See fig. 7	I_{FSM}	5 μs sine or 3 μs rect. pulse	Following any rated load condition and with rated V_{RRM} applied	A
		10 ms sine or 6 ms rect. pulse		
Non-repetitive avalanche energy	E_{AS}	$T_J = 25$ °C, $I_{AS} = 3$ A, $L = 4.4$ mH	20	mJ
Repetitive avalanche current	I_{AR}	Current decaying linearly to zero in 1 μs Frequency limited by T_J maximum $V_A = 1.5 \times V_R$ typical	3.0	A



ELECTRICAL SPECIFICATIONS					
PARAMETER	SYMBOL	TEST CONDITIONS		VALUES	UNITS
Maximum forward voltage drop See fig. 1	$V_{FM}^{(1)}$	10 A	$T_J = 25\text{ }^\circ\text{C}$	0.63	V
		20 A		0.80	
		10 A	$T_J = 125\text{ }^\circ\text{C}$	0.53	
		20 A		0.71	
Maximum reverse leakage current See fig. 2	$I_{RM}^{(1)}$	$T_J = 25\text{ }^\circ\text{C}$	$V_R = \text{rated } V_R$	1	mA
		$T_J = 125\text{ }^\circ\text{C}$		15	
Threshold voltage	$V_{F(TO)}$	$T_J = T_J \text{ maximum}$		0.255	V
Forward slope resistance	r_t			22	m Ω
Typical junction capacitance	C_T	$V_R = 5\text{ }V_{DC}$ (test signal range 100 kHz to 1 MHz), $25\text{ }^\circ\text{C}$		760	pF
Typical series inductance	L_S	Measured lead to lead 5 mm from package body		5.0	nH

Note(1) Pulse width < 300 μs , duty cycle < 2 %

THERMAL - MECHANICAL SPECIFICATIONS					
PARAMETER	SYMBOL	TEST CONDITIONS		VALUES	UNITS
Maximum junction and storage temperature range	$T_J^{(1)}, T_{Stg}$			-40 to +175	$^\circ\text{C}$
Maximum thermal resistance, junction to case	R_{thJC}	DC operation See fig. 4		2.0	$^\circ\text{C/W}$
Maximum thermal resistance, junction to ambient	R_{thJA}			50	
Approximate weight				0.3	g
				0.01	oz.
Marking device		Case style DPAK (TO-252AA)		10WQ045FNH	

Note(1) $\frac{dP_{tot}}{dT_J} < \frac{1}{R_{thJA}}$ thermal runaway condition for a diode on its own heatsink

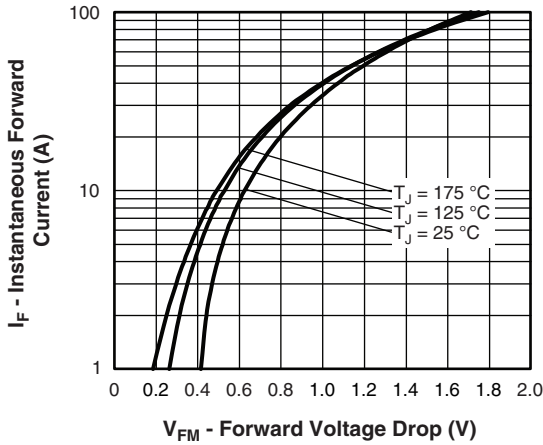

Fig. 1 - Maximum Forward Voltage Drop Characteristics

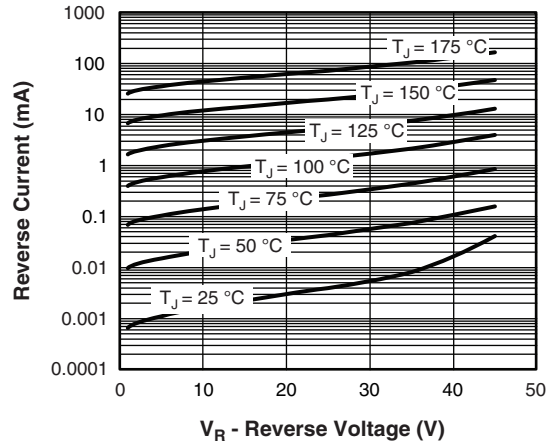

Fig. 2 - Typical Values of Reverse Current vs. Reverse Voltage

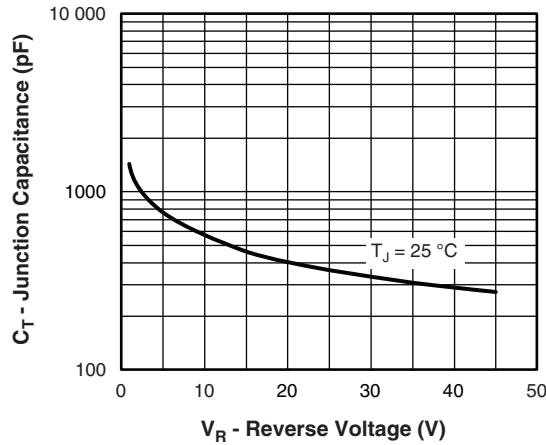

Fig. 3 - Typical Junction Capacitance vs. Reverse Voltage

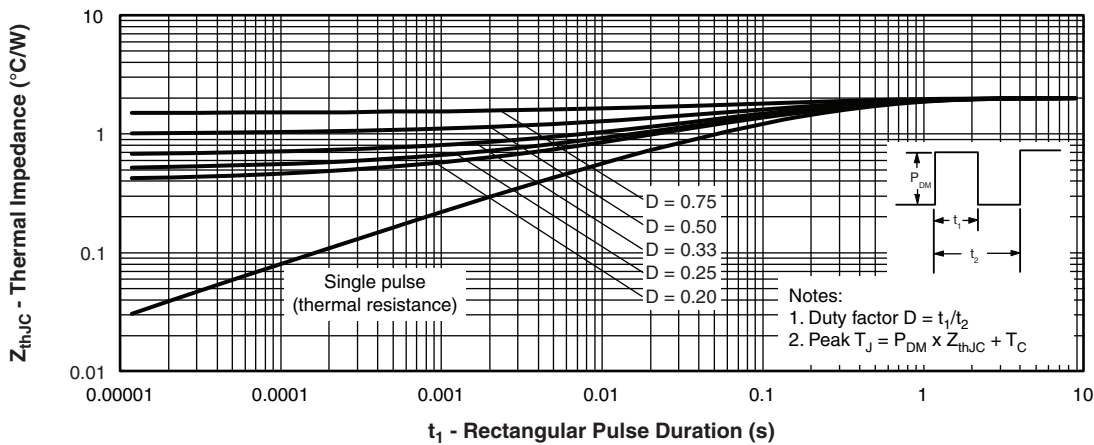

Fig. 4 - Maximum Thermal Impedance Z_{thJC} Characteristics

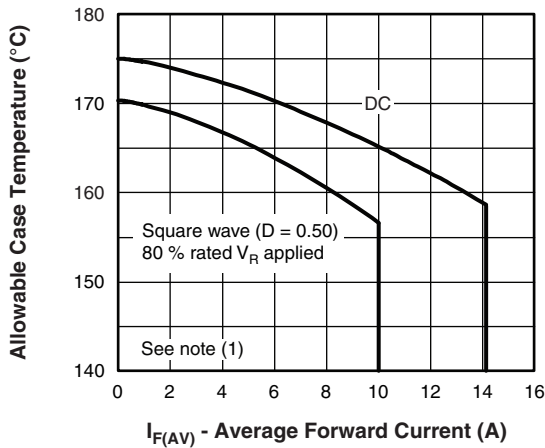

Fig. 5 - Maximum Allowable Case Temperature vs. Average Forward Current

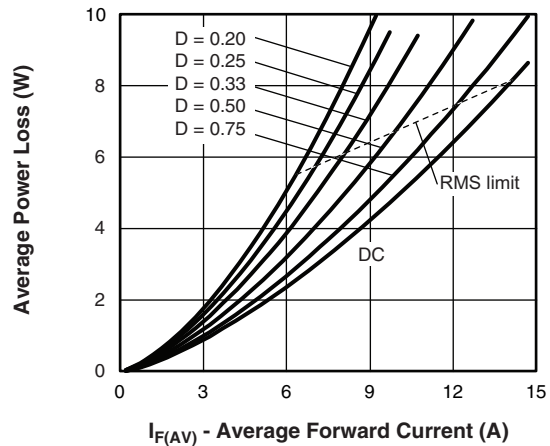

Fig. 6 - Forward Power Loss Characteristics

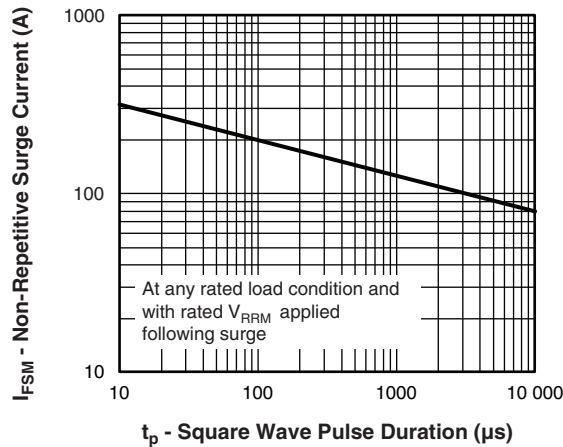

Fig. 7 - Maximum Non-Repetitive Surge Current

Note

- (1) Formula used: $T_C = T_J - (P_d + P_{d_{REV}}) \times R_{thJC}$;
- P_d = forward power loss = $I_{F(AV)} \times V_{FM}$ at $(I_{F(AV)}/D)$ (see fig. 6);
- $P_{d_{REV}}$ = inverse power loss = $V_{R1} \times I_R (1 - D)$; I_R at $V_{R1} = 80\%$ rated V_R



ORDERING INFORMATION TABLE

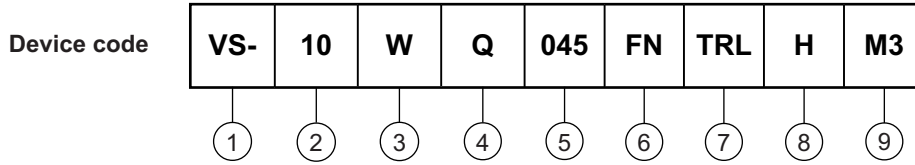

- 1** - Vishay Semiconductors product
- 2** - Current rating (10 A)
- 3** - Package identifier:
W = DPAK
- 4** - Schottky "Q" series
- 5** - Voltage rating (045 = 45 V)
- 6** - FN = TO-252AA (DPAK)
- 7** -
 - None = Tube
 - TR = Tape and reel
 - TRL = Tape and reel (left oriented)
 - TRR = Tape and reel (right oriented)
- 8** - H = AEC-Q101 qualified
- 9** - Environmental digit:
M3 = Halogen-free, RoHS-compliant, and terminations lead (Pb)-free

ORDERING INFORMATION (Example)			
PREFERRED P/N	QUANTITY PER T/R	MINIMUM ORDER QUANTITY	PACKAGING DESCRIPTION
VS-10WQ045FNHM3	75	3000	Antistatic plastic tube
VS-10WQ045FNTRHM3	2000	2000	13" diameter reel
VS-10WQ045FNTRRHM3	3000	3000	13" diameter reel
VS-10WQ045FNTRLHM3	3000	3000	13" diameter reel

LINKS TO RELATED DOCUMENTS	
Dimensions	www.vishay.com/doc?95519
Part marking information	www.vishay.com/doc?95518
Packaging information	www.vishay.com/doc?95033
SPICE model	www.vishay.com/doc?96555

DPAK (TO-252AA)

DIMENSIONS in millimeters and inches

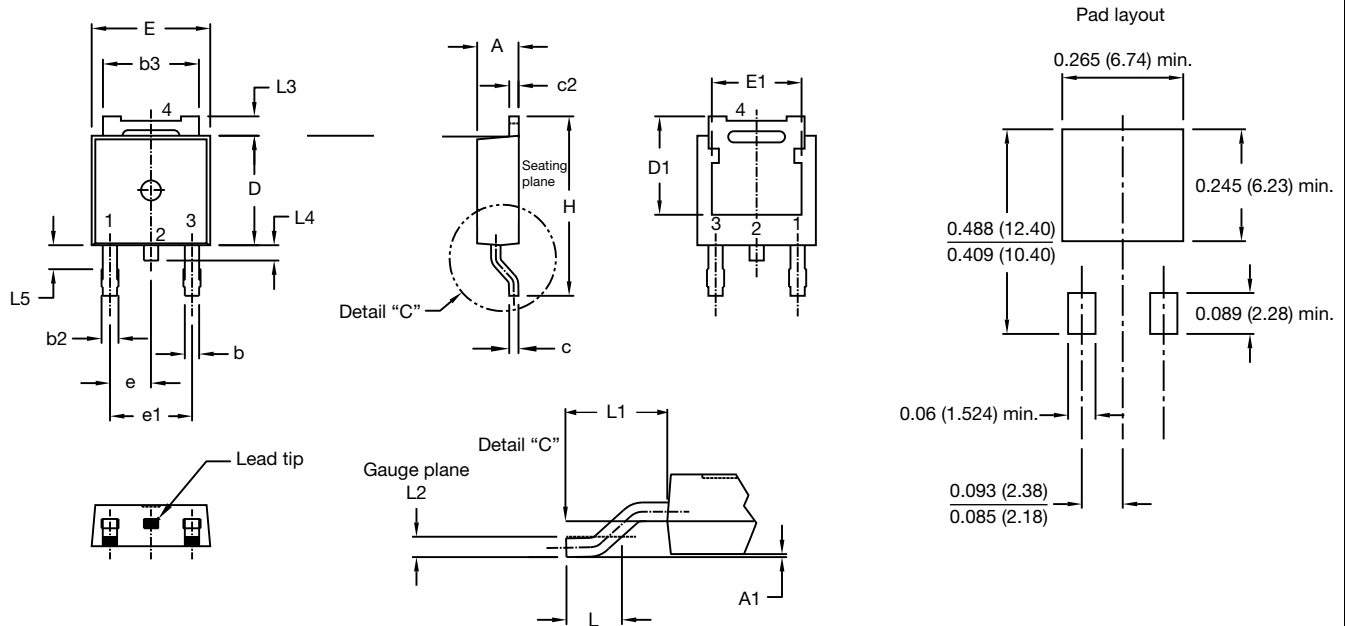

SYMBOL	MILLIMETERS		INCHES		NOTES	SYMBOL	MILLIMETERS		INCHES		NOTES
	MIN.	MAX.	MIN.	MAX.			MIN.	MAX.	MIN.	MAX.	
A	2.18	2.39	0.086	0.094		e	2.29 BSC		0.090 BSC		
A1	-	0.13	-	0.005		H	9.40	10.41	0.370	0.410	
b	0.64	0.89	0.025	0.035		L	1.40	1.78	0.055	0.070	
b2	0.76	1.14	0.030	0.045		L1	2.74 BSC		0.108 REF.		
b3	4.95	5.46	0.195	0.215	3	L2	0.51 BSC		0.020 BSC		
c	0.46	0.61	0.018	0.024		L3	0.89	1.27	0.035	0.050	3
c2	0.46	0.89	0.018	0.035		L4	-	1.02	-	0.040	
D	5.97	6.22	0.235	0.245	5	L5	1.14	1.52	0.045	0.060	2
D1	4.93	-	0.194	-	3						
E	6.35	6.73	0.250	0.265	5						
E1	4.32	-	0.170	-	3						

Notes

- (1) Dimensioning and tolerancing as per ASME Y14.5M-1994
- (2) Lead dimension uncontrolled in L5
- (3) Dimension D1, E1, L3 and b3 establish a minimum mounting surface for thermal pad
- (4) Dimensions D and E do not include mold flash. Mold flash shall not exceed 0.127 mm (0.005") per side. These dimensions are measured at the outermost extremes of the plastic body
- (5) Outline conforms to JEDEC® outline TO-252AA, except for D1 dimension



Disclaimer

ALL PRODUCT, PRODUCT SPECIFICATIONS AND DATA ARE SUBJECT TO CHANGE WITHOUT NOTICE TO IMPROVE RELIABILITY, FUNCTION OR DESIGN OR OTHERWISE.

Vishay Intertechnology, Inc., its affiliates, agents, and employees, and all persons acting on its or their behalf (collectively, "Vishay"), disclaim any and all liability for any errors, inaccuracies or incompleteness contained in any datasheet or in any other disclosure relating to any product.

Vishay makes no warranty, representation or guarantee regarding the suitability of the products for any particular purpose or the continuing production of any product. To the maximum extent permitted by applicable law, Vishay disclaims (i) any and all liability arising out of the application or use of any product, (ii) any and all liability, including without limitation special, consequential or incidental damages, and (iii) any and all implied warranties, including warranties of fitness for particular purpose, non-infringement and merchantability.

Statements regarding the suitability of products for certain types of applications are based on Vishay's knowledge of typical requirements that are often placed on Vishay products in generic applications. Such statements are not binding statements about the suitability of products for a particular application. It is the customer's responsibility to validate that a particular product with the properties described in the product specification is suitable for use in a particular application. Parameters provided in datasheets and / or specifications may vary in different applications and performance may vary over time. All operating parameters, including typical parameters, must be validated for each customer application by the customer's technical experts. Product specifications do not expand or otherwise modify Vishay's terms and conditions of purchase, including but not limited to the warranty expressed therein.

Hyperlinks included in this datasheet may direct users to third-party websites. These links are provided as a convenience and for informational purposes only. Inclusion of these hyperlinks does not constitute an endorsement or an approval by Vishay of any of the products, services or opinions of the corporation, organization or individual associated with the third-party website. Vishay disclaims any and all liability and bears no responsibility for the accuracy, legality or content of the third-party website or for that of subsequent links.

Except as expressly indicated in writing, Vishay products are not designed for use in medical, life-saving, or life-sustaining applications or for any other application in which the failure of the Vishay product could result in personal injury or death. Customers using or selling Vishay products not expressly indicated for use in such applications do so at their own risk. Please contact authorized Vishay personnel to obtain written terms and conditions regarding products designed for such applications.

No license, express or implied, by estoppel or otherwise, to any intellectual property rights is granted by this document or by any conduct of Vishay. Product names and markings noted herein may be trademarks of their respective owners.

Looking for pricing, stock, or lifecycle information?

Click below to explore more details on WIN SOURCE:

 [View VS-10WQ045FNTRLHM3 on WIN SOURCE](#)

 [Vishay Information](#)

Optimize Your Supply Chain with WIN SOURCE Solutions

-  Global Sourcing Solution
-  Obsolete Management
-  Cost Control Management
-  Shortage Management
-  Alternative Solution
-  Excess Inventory Management