



**THE DATASHEET OF
LQW15AN3N2B00D**



CHIP COILS (CHIP INDUCTORS) LQW15AN□□□□00□ REFERENCE SPECIFICATION

1. Scope

This reference specification applies to chip coils (chip inductors) LQW15AN_00 series for general electronic equipment.

2. Part Numbering

(Ex.)

| | | | | | | | | | |
|------------|-----------|-------------------|--------------------------------|----------|------------|-----------|-------------|-------------------------|------------------------------------|
| LQ | W | 15 | A | N | 1N5 | B | 0 | 0 | D |
| Product ID | Structure | Dimension (L × W) | Application and characteristic | Category | Inductance | Tolerance | Performance | Electrode specification | Packaging D: taping *B: bulk |

*B: Bulk packing is also available (taping condition: however, products without reels are put in plastic bags).

3. Part Number and Rating

| | |
|-----------------------------|-----------------|
| Operating temperature range | -55°C to +125°C |
| Storage temperature range | -55°C to +125°C |

| Customer Part number | Murata Part number | Inductance | | Q (Min.) | DC resistance (Ω max.) | Self-resonant frequency (GHz min.) | Rated current (mA) |
|----------------------|--------------------|--------------------|------------|----------|------------------------|------------------------------------|--------------------|
| | | Nominal value (nH) | Tolerance | | | | |
| | LQW15AN1N5B00D | 1.5 | B: ±0.1 nH | 10 | 0.03 | 18.0 | 1000 |
| | LQW15AN1N5C00D | 1.5 | C: ±0.2 nH | 10 | 0.03 | 18.0 | 1000 |
| | LQW15AN1N5D00D | 1.5 | D: ±0.5 nH | 10 | 0.03 | 18.0 | 1000 |
| | LQW15AN1N6C00D | 1.6 | C: ±0.2 nH | 10 | 0.07 | 17.0 | 750 |
| | LQW15AN1N6D00D | 1.6 | D: ±0.5 nH | 10 | 0.07 | 17.0 | 750 |
| | LQW15AN1N7C00D | 1.7 | C: ±0.2 nH | 10 | 0.10 | 17.0 | 640 |
| | LQW15AN1N7D00D | 1.7 | D: ±0.5 nH | 10 | 0.10 | 17.0 | 640 |
| | LQW15AN1N8C00D | 1.8 | C: ±0.2 nH | 10 | 0.16 | 16.0 | 460 |
| | LQW15AN1N8D00D | 1.8 | D: ±0.5 nH | 10 | 0.16 | 16.0 | 460 |
| | LQW15AN2N4B00D | 2.4 | B: ±0.1 nH | 20 | 0.05 | 15.0 | 850 |
| | LQW15AN2N4C00D | 2.4 | C: ±0.2 nH | 20 | 0.05 | 15.0 | 850 |
| | LQW15AN2N4D00D | 2.4 | D: ±0.5 nH | 20 | 0.05 | 15.0 | 850 |
| | LQW15AN2N5B00D | 2.5 | B: ±0.1 nH | 20 | 0.05 | 15.0 | 850 |
| | LQW15AN2N5C00D | 2.5 | C: ±0.2 nH | 20 | 0.05 | 15.0 | 850 |
| | LQW15AN2N5D00D | 2.5 | D: ±0.5 nH | 20 | 0.05 | 15.0 | 850 |
| | LQW15AN2N6B00D | 2.6 | B: ±0.1 nH | 20 | 0.05 | 15.0 | 850 |
| | LQW15AN2N6C00D | 2.6 | C: ±0.2 nH | 20 | 0.05 | 15.0 | 850 |
| | LQW15AN2N6D00D | 2.6 | D: ±0.5 nH | 20 | 0.05 | 15.0 | 850 |
| | LQW15AN2N7B00D | 2.7 | B: ±0.1 nH | 20 | 0.05 | 15.0 | 850 |
| | LQW15AN2N7C00D | 2.7 | C: ±0.2 nH | 20 | 0.05 | 15.0 | 850 |
| | LQW15AN2N7D00D | 2.7 | D: ±0.5 nH | 20 | 0.05 | 15.0 | 850 |
| | LQW15AN2N8B00D | 2.8 | B: ±0.1 nH | 20 | 0.05 | 15.0 | 850 |
| | LQW15AN2N8C00D | 2.8 | C: ±0.2 nH | 20 | 0.05 | 15.0 | 850 |
| | LQW15AN2N8D00D | 2.8 | D: ±0.5 nH | 20 | 0.05 | 15.0 | 850 |
| | LQW15AN2N9B00D | 2.9 | B: ±0.1 nH | 20 | 0.07 | 15.0 | 750 |
| | LQW15AN2N9C00D | 2.9 | C: ±0.2 nH | 20 | 0.07 | 15.0 | 750 |
| | LQW15AN2N9D00D | 2.9 | D: ±0.5 nH | 20 | 0.07 | 15.0 | 750 |
| | LQW15AN3N0B00D | 3.0 | B: ±0.1 nH | 20 | 0.07 | 15.0 | 750 |
| | LQW15AN3N0C00D | 3.0 | C: ±0.2 nH | 20 | 0.07 | 15.0 | 750 |
| | LQW15AN3N0D00D | 3.0 | D: ±0.5 nH | 20 | 0.07 | 15.0 | 750 |
| | LQW15AN3N1B00D | 3.1 | B: ±0.1 nH | 20 | 0.13 | 14.0 | 570 |

| Customer Part number | Murata Part number | Inductance | | Q (Min.) | DC resistance (Ω max.) | Self-resonant frequency (GHz min.) | Rated current (mA) |
|----------------------|--------------------|--------------------|-----------------|----------|--------------------------------|------------------------------------|--------------------|
| | | Nominal value (nH) | Tolerance | | | | |
| | LQW15AN3N1C00D | 3.1 | C: ± 0.2 nH | 20 | 0.13 | 14.0 | 570 |
| | LQW15AN3N1D00D | 3.1 | D: ± 0.5 nH | 20 | 0.13 | 14.0 | 570 |
| | LQW15AN3N2B00D | 3.2 | B: ± 0.1 nH | 15 | 0.17 | 14.0 | 500 |
| | LQW15AN3N2C00D | 3.2 | C: ± 0.2 nH | 15 | 0.17 | 14.0 | 500 |
| | LQW15AN3N2D00D | 3.2 | D: ± 0.5 nH | 15 | 0.17 | 14.0 | 500 |
| | LQW15AN3N9B00D | 3.9 | B: ± 0.1 nH | 25 | 0.07 | 10.0 | 750 |
| | LQW15AN3N9C00D | 3.9 | C: ± 0.2 nH | 25 | 0.07 | 10.0 | 750 |
| | LQW15AN3N9D00D | 3.9 | D: ± 0.5 nH | 25 | 0.07 | 10.0 | 750 |
| | LQW15AN4N1B00D | 4.1 | B: ± 0.1 nH | 25 | 0.07 | 10.0 | 750 |
| | LQW15AN4N1C00D | 4.1 | C: ± 0.2 nH | 25 | 0.07 | 10.0 | 750 |
| | LQW15AN4N1D00D | 4.1 | D: ± 0.5 nH | 25 | 0.07 | 10.0 | 750 |
| | LQW15AN4N3B00D | 4.3 | B: ± 0.1 nH | 25 | 0.07 | 10.0 | 750 |
| | LQW15AN4N3C00D | 4.3 | C: ± 0.2 nH | 25 | 0.07 | 10.0 | 750 |
| | LQW15AN4N3D00D | 4.3 | D: ± 0.5 nH | 25 | 0.07 | 10.0 | 750 |
| | LQW15AN4N4B00D | 4.4 | B: ± 0.1 nH | 25 | 0.07 | 8.0 | 750 |
| | LQW15AN4N4C00D | 4.4 | C: ± 0.2 nH | 25 | 0.07 | 8.0 | 750 |
| | LQW15AN4N4D00D | 4.4 | D: ± 0.5 nH | 25 | 0.07 | 8.0 | 750 |
| | LQW15AN4N5B00D | 4.5 | B: ± 0.1 nH | 25 | 0.07 | 8.0 | 750 |
| | LQW15AN4N5C00D | 4.5 | C: ± 0.2 nH | 25 | 0.07 | 8.0 | 750 |
| | LQW15AN4N5D00D | 4.5 | D: ± 0.5 nH | 25 | 0.07 | 8.0 | 750 |
| | LQW15AN4N6B00D | 4.6 | B: ± 0.1 nH | 25 | 0.07 | 8.0 | 750 |
| | LQW15AN4N6C00D | 4.6 | C: ± 0.2 nH | 25 | 0.07 | 8.0 | 750 |
| | LQW15AN4N6D00D | 4.6 | D: ± 0.5 nH | 25 | 0.07 | 8.0 | 750 |
| | LQW15AN4N7B00D | 4.7 | B: ± 0.1 nH | 25 | 0.07 | 8.0 | 750 |
| | LQW15AN4N7C00D | 4.7 | C: ± 0.2 nH | 25 | 0.07 | 8.0 | 750 |
| | LQW15AN4N7D00D | 4.7 | D: ± 0.5 nH | 25 | 0.07 | 8.0 | 750 |
| | LQW15AN4N8B00D | 4.8 | B: ± 0.1 nH | 25 | 0.07 | 8.0 | 750 |
| | LQW15AN4N8C00D | 4.8 | C: ± 0.2 nH | 25 | 0.07 | 8.0 | 750 |
| | LQW15AN4N8D00D | 4.8 | D: ± 0.5 nH | 25 | 0.07 | 8.0 | 750 |
| | LQW15AN4N9B00D | 4.9 | B: ± 0.1 nH | 25 | 0.12 | 8.0 | 600 |
| | LQW15AN4N9C00D | 4.9 | C: ± 0.2 nH | 25 | 0.12 | 8.0 | 600 |
| | LQW15AN4N9D00D | 4.9 | D: ± 0.5 nH | 25 | 0.12 | 8.0 | 600 |
| | LQW15AN5N0B00D | 5.0 | B: ± 0.1 nH | 25 | 0.12 | 8.0 | 600 |
| | LQW15AN5N0C00D | 5.0 | C: ± 0.2 nH | 25 | 0.12 | 8.0 | 600 |
| | LQW15AN5N0D00D | 5.0 | D: ± 0.5 nH | 25 | 0.12 | 8.0 | 600 |
| | LQW15AN5N1B00D | 5.1 | B: ± 0.1 nH | 25 | 0.12 | 8.0 | 600 |
| | LQW15AN5N1C00D | 5.1 | C: ± 0.2 nH | 25 | 0.12 | 8.0 | 600 |
| | LQW15AN5N1D00D | 5.1 | D: ± 0.5 nH | 25 | 0.12 | 8.0 | 600 |
| | LQW15AN5N8B00D | 5.8 | B: ± 0.1 nH | 25 | 0.09 | 8.0 | 700 |
| | LQW15AN5N8C00D | 5.8 | C: ± 0.2 nH | 25 | 0.09 | 8.0 | 700 |
| | LQW15AN5N8D00D | 5.8 | D: ± 0.5 nH | 25 | 0.09 | 8.0 | 700 |
| | LQW15AN6N2B00D | 6.2 | B: ± 0.1 nH | 25 | 0.09 | 8.0 | 700 |
| | LQW15AN6N2C00D | 6.2 | C: ± 0.2 nH | 25 | 0.09 | 8.0 | 700 |
| | LQW15AN6N2D00D | 6.2 | D: ± 0.5 nH | 25 | 0.09 | 8.0 | 700 |
| | LQW15AN6N3B00D | 6.3 | B: ± 0.1 nH | 25 | 0.09 | 6.0 | 700 |
| | LQW15AN6N3C00D | 6.3 | C: ± 0.2 nH | 25 | 0.09 | 6.0 | 700 |

| Customer Part number | Murata Part number | Inductance | | Q (Min.) | DC resistance (Ω max.) | Self-resonant frequency (GHz min.) | Rated current (mA) |
|----------------------|--------------------|--------------------|-----------------|----------|--------------------------------|------------------------------------|--------------------|
| | | Nominal value (nH) | Tolerance | | | | |
| | LQW15AN6N3D00D | 6.3 | D: ± 0.5 nH | 25 | 0.09 | 6.0 | 700 |
| | LQW15AN6N4B00D | 6.4 | B: ± 0.1 nH | 25 | 0.09 | 6.0 | 700 |
| | LQW15AN6N4C00D | 6.4 | C: ± 0.2 nH | 25 | 0.09 | 6.0 | 700 |
| | LQW15AN6N4D00D | 6.4 | D: ± 0.5 nH | 25 | 0.09 | 6.0 | 700 |
| | LQW15AN6N5B00D | 6.5 | B: ± 0.1 nH | 25 | 0.09 | 6.0 | 700 |
| | LQW15AN6N5C00D | 6.5 | C: ± 0.2 nH | 25 | 0.09 | 6.0 | 700 |
| | LQW15AN6N5D00D | 6.5 | D: ± 0.5 nH | 25 | 0.09 | 6.0 | 700 |
| | LQW15AN6N6B00D | 6.6 | B: ± 0.1 nH | 25 | 0.09 | 6.0 | 700 |
| | LQW15AN6N6C00D | 6.6 | C: ± 0.2 nH | 25 | 0.09 | 6.0 | 700 |
| | LQW15AN6N6D00D | 6.6 | D: ± 0.5 nH | 25 | 0.09 | 6.0 | 700 |
| | LQW15AN6N7B00D | 6.7 | B: ± 0.1 nH | 25 | 0.09 | 6.0 | 700 |
| | LQW15AN6N7C00D | 6.7 | C: ± 0.2 nH | 25 | 0.09 | 6.0 | 700 |
| | LQW15AN6N7D00D | 6.7 | D: ± 0.5 nH | 25 | 0.09 | 6.0 | 700 |
| | LQW15AN6N8G00D | 6.8 | G: $\pm 2\%$ | 25 | 0.09 | 6.0 | 700 |
| | LQW15AN6N8H00D | 6.8 | H: $\pm 3\%$ | 25 | 0.09 | 6.0 | 700 |
| | LQW15AN6N8J00D | 6.8 | J: $\pm 5\%$ | 25 | 0.09 | 6.0 | 700 |
| | LQW15AN6N9G00D | 6.9 | G: $\pm 2\%$ | 25 | 0.13 | 6.0 | 570 |
| | LQW15AN6N9H00D | 6.9 | H: $\pm 3\%$ | 25 | 0.13 | 6.0 | 570 |
| | LQW15AN6N9J00D | 6.9 | J: $\pm 5\%$ | 25 | 0.13 | 6.0 | 570 |
| | LQW15AN7N0G00D | 7.0 | G: $\pm 2\%$ | 25 | 0.13 | 6.0 | 570 |
| | LQW15AN7N0H00D | 7.0 | H: $\pm 3\%$ | 25 | 0.13 | 6.0 | 570 |
| | LQW15AN7N0J00D | 7.0 | J: $\pm 5\%$ | 25 | 0.13 | 6.0 | 570 |
| | LQW15AN7N1G00D | 7.1 | G: $\pm 2\%$ | 25 | 0.13 | 6.0 | 570 |
| | LQW15AN7N1H00D | 7.1 | H: $\pm 3\%$ | 25 | 0.13 | 6.0 | 570 |
| | LQW15AN7N1J00D | 7.1 | J: $\pm 5\%$ | 25 | 0.13 | 6.0 | 570 |
| | LQW15AN7N2G00D | 7.2 | G: $\pm 2\%$ | 25 | 0.13 | 6.0 | 570 |
| | LQW15AN7N2H00D | 7.2 | H: $\pm 3\%$ | 25 | 0.13 | 6.0 | 570 |
| | LQW15AN7N2J00D | 7.2 | J: $\pm 5\%$ | 25 | 0.13 | 6.0 | 570 |
| | LQW15AN7N3G00D | 7.3 | G: $\pm 2\%$ | 25 | 0.13 | 6.0 | 570 |
| | LQW15AN7N3H00D | 7.3 | H: $\pm 3\%$ | 25 | 0.13 | 6.0 | 570 |
| | LQW15AN7N3J00D | 7.3 | J: $\pm 5\%$ | 25 | 0.13 | 6.0 | 570 |
| | LQW15AN7N5G00D | 7.5 | G: $\pm 2\%$ | 25 | 0.13 | 6.0 | 570 |
| | LQW15AN7N5H00D | 7.5 | H: $\pm 3\%$ | 25 | 0.13 | 6.0 | 570 |
| | LQW15AN7N5J00D | 7.5 | J: $\pm 5\%$ | 25 | 0.13 | 6.0 | 570 |
| | LQW15AN8N2G00D | 8.2 | G: $\pm 2\%$ | 25 | 0.14 | 5.5 | 540 |
| | LQW15AN8N2H00D | 8.2 | H: $\pm 3\%$ | 25 | 0.14 | 5.5 | 540 |
| | LQW15AN8N2J00D | 8.2 | J: $\pm 5\%$ | 25 | 0.14 | 5.5 | 540 |
| | LQW15AN8N6G00D | 8.6 | G: $\pm 2\%$ | 25 | 0.14 | 5.5 | 540 |
| | LQW15AN8N6H00D | 8.6 | H: $\pm 3\%$ | 25 | 0.14 | 5.5 | 540 |
| | LQW15AN8N6J00D | 8.6 | J: $\pm 5\%$ | 25 | 0.14 | 5.5 | 540 |
| | LQW15AN8N7G00D | 8.7 | G: $\pm 2\%$ | 25 | 0.14 | 5.5 | 540 |
| | LQW15AN8N7H00D | 8.7 | H: $\pm 3\%$ | 25 | 0.14 | 5.5 | 540 |
| | LQW15AN8N7J00D | 8.7 | J: $\pm 5\%$ | 25 | 0.14 | 5.5 | 540 |
| | LQW15AN8N8G00D | 8.8 | G: $\pm 2\%$ | 25 | 0.14 | 5.5 | 540 |
| | LQW15AN8N8H00D | 8.8 | H: $\pm 3\%$ | 25 | 0.14 | 5.5 | 540 |
| | LQW15AN8N8J00D | 8.8 | J: $\pm 5\%$ | 25 | 0.14 | 5.5 | 540 |

| Customer Part number | Murata Part number | Inductance | | Q (Min.) | DC resistance (Ω max.) | Self-resonant frequency (GHz min.) | Rated current (mA) |
|----------------------|--------------------|--------------------|--------------|----------|--------------------------------|------------------------------------|--------------------|
| | | Nominal value (nH) | Tolerance | | | | |
| | LQW15AN8N9G00D | 8.9 | G: $\pm 2\%$ | 25 | 0.14 | 5.5 | 540 |
| | LQW15AN8N9H00D | 8.9 | H: $\pm 3\%$ | 25 | 0.14 | 5.5 | 540 |
| | LQW15AN8N9J00D | 8.9 | J: $\pm 5\%$ | 25 | 0.14 | 5.5 | 540 |
| | LQW15AN9N0G00D | 9.0 | G: $\pm 2\%$ | 25 | 0.14 | 5.5 | 540 |
| | LQW15AN9N0H00D | 9.0 | H: $\pm 3\%$ | 25 | 0.14 | 5.5 | 540 |
| | LQW15AN9N0J00D | 9.0 | J: $\pm 5\%$ | 25 | 0.14 | 5.5 | 540 |
| | LQW15AN9N1G00D | 9.1 | G: $\pm 2\%$ | 25 | 0.14 | 5.5 | 540 |
| | LQW15AN9N1H00D | 9.1 | H: $\pm 3\%$ | 25 | 0.14 | 5.5 | 540 |
| | LQW15AN9N1J00D | 9.1 | J: $\pm 5\%$ | 25 | 0.14 | 5.5 | 540 |
| | LQW15AN9N2G00D | 9.2 | G: $\pm 2\%$ | 25 | 0.14 | 5.5 | 540 |
| | LQW15AN9N2H00D | 9.2 | H: $\pm 3\%$ | 25 | 0.14 | 5.5 | 540 |
| | LQW15AN9N2J00D | 9.2 | J: $\pm 5\%$ | 25 | 0.14 | 5.5 | 540 |
| | LQW15AN9N3G00D | 9.3 | G: $\pm 2\%$ | 25 | 0.14 | 5.5 | 540 |
| | LQW15AN9N3H00D | 9.3 | H: $\pm 3\%$ | 25 | 0.14 | 5.5 | 540 |
| | LQW15AN9N3J00D | 9.3 | J: $\pm 5\%$ | 25 | 0.14 | 5.5 | 540 |
| | LQW15AN9N4G00D | 9.4 | G: $\pm 2\%$ | 25 | 0.14 | 5.5 | 540 |
| | LQW15AN9N4H00D | 9.4 | H: $\pm 3\%$ | 25 | 0.14 | 5.5 | 540 |
| | LQW15AN9N4J00D | 9.4 | J: $\pm 5\%$ | 25 | 0.14 | 5.5 | 540 |
| | LQW15AN9N5G00D | 9.5 | G: $\pm 2\%$ | 25 | 0.14 | 5.5 | 540 |
| | LQW15AN9N5H00D | 9.5 | H: $\pm 3\%$ | 25 | 0.14 | 5.5 | 540 |
| | LQW15AN9N5J00D | 9.5 | J: $\pm 5\%$ | 25 | 0.14 | 5.5 | 540 |
| | LQW15AN9N6G00D | 9.6 | G: $\pm 2\%$ | 25 | 0.14 | 5.5 | 540 |
| | LQW15AN9N6H00D | 9.6 | H: $\pm 3\%$ | 25 | 0.14 | 5.5 | 540 |
| | LQW15AN9N6J00D | 9.6 | J: $\pm 5\%$ | 25 | 0.14 | 5.5 | 540 |
| | LQW15AN9N7G00D | 9.7 | G: $\pm 2\%$ | 25 | 0.14 | 5.5 | 540 |
| | LQW15AN9N7H00D | 9.7 | H: $\pm 3\%$ | 25 | 0.14 | 5.5 | 540 |
| | LQW15AN9N7J00D | 9.7 | J: $\pm 5\%$ | 25 | 0.14 | 5.5 | 540 |
| | LQW15AN9N8G00D | 9.8 | G: $\pm 2\%$ | 25 | 0.14 | 5.5 | 540 |
| | LQW15AN9N8H00D | 9.8 | H: $\pm 3\%$ | 25 | 0.14 | 5.5 | 540 |
| | LQW15AN9N8J00D | 9.8 | J: $\pm 5\%$ | 25 | 0.14 | 5.5 | 540 |
| | LQW15AN9N9G00D | 9.9 | G: $\pm 2\%$ | 25 | 0.14 | 5.5 | 540 |
| | LQW15AN9N9H00D | 9.9 | H: $\pm 3\%$ | 25 | 0.14 | 5.5 | 540 |
| | LQW15AN9N9J00D | 9.9 | J: $\pm 5\%$ | 25 | 0.14 | 5.5 | 540 |
| | LQW15AN10NG00D | 10 | G: $\pm 2\%$ | 25 | 0.17 | 5.5 | 500 |
| | LQW15AN10NH00D | 10 | H: $\pm 3\%$ | 25 | 0.17 | 5.5 | 500 |
| | LQW15AN10NJ00D | 10 | J: $\pm 5\%$ | 25 | 0.17 | 5.5 | 500 |
| | LQW15AN11NG00D | 11 | G: $\pm 2\%$ | 30 | 0.14 | 5.5 | 500 |
| | LQW15AN11NH00D | 11 | H: $\pm 3\%$ | 30 | 0.14 | 5.5 | 500 |
| | LQW15AN11NJ00D | 11 | J: $\pm 5\%$ | 30 | 0.14 | 5.5 | 500 |
| | LQW15AN12NG00D | 12 | G: $\pm 2\%$ | 30 | 0.14 | 5.5 | 500 |
| | LQW15AN12NH00D | 12 | H: $\pm 3\%$ | 30 | 0.14 | 5.5 | 500 |
| | LQW15AN12NJ00D | 12 | J: $\pm 5\%$ | 30 | 0.14 | 5.5 | 500 |
| | LQW15AN13NG00D | 13 | G: $\pm 2\%$ | 25 | 0.21 | 5.0 | 430 |
| | LQW15AN13NH00D | 13 | H: $\pm 3\%$ | 25 | 0.21 | 5.0 | 430 |
| | LQW15AN13NJ00D | 13 | J: $\pm 5\%$ | 25 | 0.21 | 5.0 | 430 |
| | LQW15AN15NG00D | 15 | G: $\pm 2\%$ | 30 | 0.16 | 5.0 | 460 |

| Customer Part number | Murata Part number | Inductance | | Q (Min.) | DC resistance (Ω max.) | Self-resonant frequency (GHz min.) | Rated current (mA) |
|----------------------|--------------------|--------------------|--------------|----------|--------------------------------|------------------------------------|--------------------|
| | | Nominal value (nH) | Tolerance | | | | |
| | LQW15AN15NH00D | 15 | H: $\pm 3\%$ | 30 | 0.16 | 5.0 | 460 |
| | LQW15AN15NJ00D | 15 | J: $\pm 5\%$ | 30 | 0.16 | 5.0 | 460 |
| | LQW15AN16NG00D | 16 | G: $\pm 2\%$ | 25 | 0.24 | 4.5 | 370 |
| | LQW15AN16NH00D | 16 | H: $\pm 3\%$ | 25 | 0.24 | 4.5 | 370 |
| | LQW15AN16NJ00D | 16 | J: $\pm 5\%$ | 25 | 0.24 | 4.5 | 370 |
| | LQW15AN18NG00D | 18 | G: $\pm 2\%$ | 25 | 0.27 | 4.5 | 370 |
| | LQW15AN18NH00D | 18 | H: $\pm 3\%$ | 25 | 0.27 | 4.5 | 370 |
| | LQW15AN18NJ00D | 18 | J: $\pm 5\%$ | 25 | 0.27 | 4.5 | 370 |
| | LQW15AN19NG00D | 19 | G: $\pm 2\%$ | 25 | 0.27 | 4.5 | 370 |
| | LQW15AN19NH00D | 19 | H: $\pm 3\%$ | 25 | 0.27 | 4.5 | 370 |
| | LQW15AN19NJ00D | 19 | J: $\pm 5\%$ | 25 | 0.27 | 4.5 | 370 |
| | LQW15AN20NG00D | 20 | G: $\pm 2\%$ | 25 | 0.27 | 4.0 | 370 |
| | LQW15AN20NH00D | 20 | H: $\pm 3\%$ | 25 | 0.27 | 4.0 | 370 |
| | LQW15AN20NJ00D | 20 | J: $\pm 5\%$ | 25 | 0.27 | 4.0 | 370 |
| | LQW15AN22NG00D | 22 | G: $\pm 2\%$ | 25 | 0.30 | 4.0 | 310 |
| | LQW15AN22NH00D | 22 | H: $\pm 3\%$ | 25 | 0.30 | 4.0 | 310 |
| | LQW15AN22NJ00D | 22 | J: $\pm 5\%$ | 25 | 0.30 | 4.0 | 310 |
| | LQW15AN23NG00D | 23 | G: $\pm 2\%$ | 25 | 0.30 | 3.8 | 310 |
| | LQW15AN23NH00D | 23 | H: $\pm 3\%$ | 25 | 0.30 | 3.8 | 310 |
| | LQW15AN23NJ00D | 23 | J: $\pm 5\%$ | 25 | 0.30 | 3.8 | 310 |
| | LQW15AN24NG00D | 24 | G: $\pm 2\%$ | 25 | 0.52 | 3.5 | 280 |
| | LQW15AN24NH00D | 24 | H: $\pm 3\%$ | 25 | 0.52 | 3.5 | 280 |
| | LQW15AN24NJ00D | 24 | J: $\pm 5\%$ | 25 | 0.52 | 3.5 | 280 |
| | LQW15AN27NG00D | 27 | G: $\pm 2\%$ | 25 | 0.52 | 3.5 | 280 |
| | LQW15AN27NH00D | 27 | H: $\pm 3\%$ | 25 | 0.52 | 3.5 | 280 |
| | LQW15AN27NJ00D | 27 | J: $\pm 5\%$ | 25 | 0.52 | 3.5 | 280 |
| | LQW15AN30NG00D | 30 | G: $\pm 2\%$ | 25 | 0.58 | 3.3 | 270 |
| | LQW15AN30NH00D | 30 | H: $\pm 3\%$ | 25 | 0.58 | 3.3 | 270 |
| | LQW15AN30NJ00D | 30 | J: $\pm 5\%$ | 25 | 0.58 | 3.3 | 270 |
| | LQW15AN33NG00D | 33 | G: $\pm 2\%$ | 25 | 0.63 | 3.2 | 260 |
| | LQW15AN33NH00D | 33 | H: $\pm 3\%$ | 25 | 0.63 | 3.2 | 260 |
| | LQW15AN33NJ00D | 33 | J: $\pm 5\%$ | 25 | 0.63 | 3.2 | 260 |
| | LQW15AN36NG00D | 36 | G: $\pm 2\%$ | 25 | 0.63 | 3.1 | 260 |
| | LQW15AN36NH00D | 36 | H: $\pm 3\%$ | 25 | 0.63 | 3.1 | 260 |
| | LQW15AN36NJ00D | 36 | J: $\pm 5\%$ | 25 | 0.63 | 3.1 | 260 |
| | LQW15AN39NG00D | 39 | G: $\pm 2\%$ | 25 | 0.70 | 3.0 | 250 |
| | LQW15AN39NH00D | 39 | H: $\pm 3\%$ | 25 | 0.70 | 3.0 | 250 |
| | LQW15AN39NJ00D | 39 | J: $\pm 5\%$ | 25 | 0.70 | 3.0 | 250 |
| | LQW15AN40NG00D | 40 | G: $\pm 2\%$ | 25 | 0.70 | 3.0 | 250 |
| | LQW15AN40NH00D | 40 | H: $\pm 3\%$ | 25 | 0.70 | 3.0 | 250 |
| | LQW15AN40NJ00D | 40 | J: $\pm 5\%$ | 25 | 0.70 | 3.0 | 250 |
| | LQW15AN43NG00D | 43 | G: $\pm 2\%$ | 25 | 0.70 | 3.0 | 250 |
| | LQW15AN43NH00D | 43 | H: $\pm 3\%$ | 25 | 0.70 | 3.0 | 250 |
| | LQW15AN43NJ00D | 43 | J: $\pm 5\%$ | 25 | 0.70 | 3.0 | 250 |
| | LQW15AN47NG00D | 47 | G: $\pm 2\%$ | 25 | 1.08 | 2.9 | 210 |
| | LQW15AN47NH00D | 47 | H: $\pm 3\%$ | 25 | 1.08 | 2.9 | 210 |

| Customer Part number | Murata Part number | Inductance | | Q (Min.) | DC resistance (Ω max.) | Self-resonant frequency (GHz min.) | Rated current (mA) |
|----------------------|--------------------|--------------------|--------------|----------|--------------------------------|------------------------------------|--------------------|
| | | Nominal value (nH) | Tolerance | | | | |
| | LQW15AN47NJ00D | 47 | J: $\pm 5\%$ | 25 | 1.08 | 2.9 | 210 |
| | LQW15AN51NG00D | 51 | G: $\pm 2\%$ | 25 | 1.08 | 2.85 | 210 |
| | LQW15AN51NH00D | 51 | H: $\pm 3\%$ | 25 | 1.08 | 2.85 | 210 |
| | LQW15AN51NJ00D | 51 | J: $\pm 5\%$ | 25 | 1.08 | 2.85 | 210 |
| | LQW15AN56NG00D | 56 | G: $\pm 2\%$ | 25 | 1.17 | 2.8 | 200 |
| | LQW15AN56NH00D | 56 | H: $\pm 3\%$ | 25 | 1.17 | 2.8 | 200 |
| | LQW15AN56NJ00D | 56 | J: $\pm 5\%$ | 25 | 1.17 | 2.8 | 200 |
| | LQW15AN62NG00D | 62 | G: $\pm 2\%$ | 20 | 1.82 | 2.6 | 145 |
| | LQW15AN62NH00D | 62 | H: $\pm 3\%$ | 20 | 1.82 | 2.6 | 145 |
| | LQW15AN62NJ00D | 62 | J: $\pm 5\%$ | 20 | 1.82 | 2.6 | 145 |
| | LQW15AN68NG00D | 68 | G: $\pm 2\%$ | 20 | 1.96 | 2.5 | 140 |
| | LQW15AN68NJ00D | 68 | J: $\pm 5\%$ | 20 | 1.96 | 2.5 | 140 |
| | LQW15AN72NG00D | 72 | G: $\pm 2\%$ | 20 | 2.10 | 2.5 | 135 |
| | LQW15AN72NJ00D | 72 | J: $\pm 5\%$ | 20 | 2.10 | 2.5 | 135 |
| | LQW15AN75NG00D | 75 | G: $\pm 2\%$ | 20 | 2.10 | 2.4 | 135 |
| | LQW15AN75NJ00D | 75 | J: $\pm 5\%$ | 20 | 2.10 | 2.4 | 135 |
| | LQW15AN82NG00D | 82 | G: $\pm 2\%$ | 20 | 2.24 | 2.3 | 130 |
| | LQW15AN82NJ00D | 82 | J: $\pm 5\%$ | 20 | 2.24 | 2.3 | 130 |
| | LQW15AN91NG00D | 91 | G: $\pm 2\%$ | 20 | 2.38 | 2.1 | 125 |
| | LQW15AN91NJ00D | 91 | J: $\pm 5\%$ | 20 | 2.38 | 2.1 | 125 |
| | LQW15ANR10J00D | 100 | J: $\pm 5\%$ | 20 | 2.52 | 1.5 | 120 |
| | LQW15ANR12J00D | 120 | J: $\pm 5\%$ | 20 | 2.66 | 1.0 | 110 |

4. Testing Conditions

| | |
|----------------------------|---|
| Unless otherwise specified | Temperature: ordinary temperature (15°C to 35°C) Humidity: ordinary humidity [25% to 85% (RH)] |
| In case of doubt | Temperature: 20°C \pm 2°C Humidity: 60% to 70% (RH) Atmospheric pressure: 86 kPa to 106 kPa |

5. Appearance and Dimensions

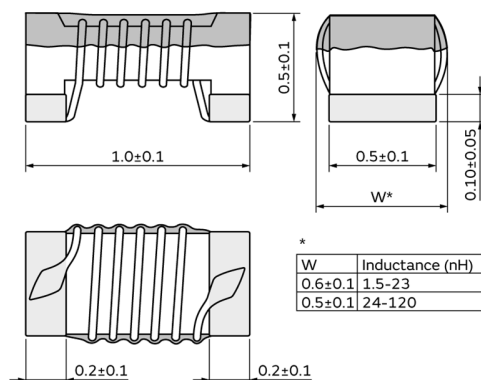

(in mm)

Unit mass (typical value): 0.0008 g

6. Marking

No marking.

7. Electrical Performance

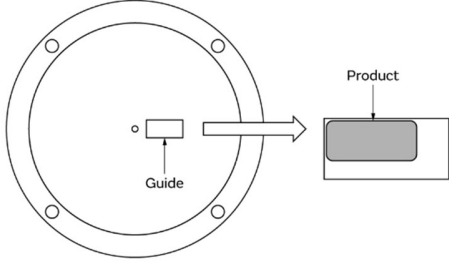
| No. | Item | Specification | Test method | | | | | | | | | | |
|------------|-------------------------|-------------------------------------|--|------------|---------|--|---|---------|-----------------|---------|----------------|---------|-----------------|
| 7.1 | Inductance | Meet chapter 3 ratings. | Measuring equipment: Keysight E4991A or the equivalent Measuring frequency: <table border="1" style="margin-left: 20px;"> <tr> <td>Inductance</td> <td colspan="2">100 MHz</td> </tr> <tr> <td rowspan="3">Q</td> <td>250 MHz</td> <td>1.5 nH to 43 nH</td> </tr> <tr> <td>200 MHz</td> <td>47 nH to 68 nH</td> </tr> <tr> <td>150 MHz</td> <td>72 nH to 120 nH</td> </tr> </table> Measuring conditions: Measurement signal level: Approx. 0 dBm Measurement terminal distance: 0.5 mm Electrical length: 10.0 mm Measuring fixture: Keysight 16197A Position the chip coil under test as shown in the measuring example below and connect it to the electrode by applying weight. Measurement example: | Inductance | 100 MHz | | Q | 250 MHz | 1.5 nH to 43 nH | 200 MHz | 47 nH to 68 nH | 150 MHz | 72 nH to 120 nH |
| Inductance | 100 MHz | | | | | | | | | | | | |
| Q | 250 MHz | 1.5 nH to 43 nH | | | | | | | | | | | |
| | 200 MHz | 47 nH to 68 nH | | | | | | | | | | | |
| | 150 MHz | 72 nH to 120 nH | | | | | | | | | | | |
| 7.2 | Q | Meet chapter 3 ratings. |  <p style="text-align: center;">Guide</p> <p style="text-align: right;">Product</p> Measuring method: see "Electrical performance: Measuring method for inductance/Q" in the chapter "16. Appendix". | | | | | | | | | | |
| 7.3 | DC resistance | Meet chapter 3 ratings. | Measuring equipment: digital multimeter | | | | | | | | | | |
| 7.4 | Self-resonant frequency | Meet chapter 3 ratings. | Measuring equipment: Keysight N5230A or the equivalent | | | | | | | | | | |
| 7.5 | Rated current | Product temperature rise: 20°C max. | Apply the rated current specified in chapter 3. | | | | | | | | | | |

8. Mechanical Performance

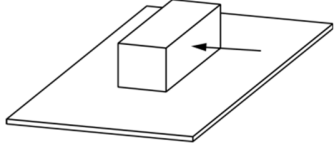
| No. | Item | Specification | Test method |
|-----|------------|---|--|
| 8.1 | Shear test | No significant mechanical damage or no sign of electrode peeling off shall be observed. | Test substrate: glass-epoxy substrate Force application direction:  <p style="margin-left: 20px;">Applying force: 5 N Holding time: 5 s±1 s</p> |

| No. | Item | Specification | Test method |
|-----|------------------------------|---|--|
| 8.2 | Bending test | No significant mechanical damage or no sign of electrode peeling off shall be observed. | <p>Test substrate: glass-epoxy substrate (100 mm × 40 mm × 0.8 mm) Pressurizing speed: 1 mm/s Deflection: 2 mm Holding time: 5 s</p>  |
| 8.3 | Vibration | Appearance shall have no significant mechanical damage. | <p>Oscillation frequency: 10 Hz to 55 Hz to 10 Hz, for approx. 1 min Total amplitude: 1.5 mm Test time: 3 directions perpendicular to each other, 2 h for each direction (6 h in total)</p> |
| 8.4 | Solderability | 90% or more of the outer electrode shall be covered with new solder seamlessly. | <p>Flux: immersed in ethanol solution [including an activator with a chlorine conversion value of 0.06(wt)%] with a rosin content of 25(wt)% for 5 s to 10 s. Solder: Sn-3.0Ag-0.5Cu solder Pre-heating: 150°C±10°C/60 s to 90 s Solder temperature: 240°C±5°C Immersion time: 3 s±1 s</p> |
| 8.5 | Resistance to soldering heat | Appearance: No significant mechanical damage shall be observed. Inductance change rate: within ±5% | <p>Flux: immersed in ethanol solution [including an activator with a chlorine conversion value of 0.06(wt)%] with a rosin content of 25(wt)% for 5 s to 10 s. Solder: Sn-3.0Ag-0.5Cu solder Pre-heating: 150°C±10°C/60 s to 90 s Solder temperature: 270°C±5°C Immersion time: 10 s±1 s Post-treatment: left at a room condition for 24 h±2 h</p> |

9. Environmental Performance

The product is soldered on a substrate for test.

| No. | Item | Specification | Test method |
|-----|-------------------|---|---|
| 9.1 | Heat resistance | Appearance: No significant mechanical damage shall be observed. Inductance change rate: within ±5% Q change rate: within ±20% | <p>Temperature: 125°C±2°C Test time: 1000 h (+48 h, -0 h) Post-treatment: left at a room condition for 24 h±2 h</p> |
| 9.2 | Cold resistance | Appearance: No significant mechanical damage shall be observed. Inductance change rate: within ±5% Q change rate: within ±20% | <p>Temperature: -55°C±2°C Test time: 1000 h (+48 h, -0 h) Post-treatment: left at a room condition for 24 h±2 h</p> |
| 9.3 | Humidity | Appearance: No significant mechanical damage shall be observed. Inductance change rate: within ±5% Q change rate: within ±20% | <p>Temperature: 70°C±2°C Humidity: 90% (RH) to 95% (RH) Test time: 1000 h (+48 h, -0 h) Post-treatment: left at a room condition for 24 h±2 h</p> |
| 9.4 | Temperature cycle | Appearance: No significant mechanical damage shall be observed. Inductance change rate: within ±5% Q change rate: within ±20% | <p>Single cycle conditions: Step 1: -55°C±2°C/30 min±3 min Step 2: ordinary temperature/10 min to 15 min Step 3: +125°C±2°C/30 min±3 min Step 4: ordinary temperature/10 min to 15 min Number of testing: 10 cycles Post-treatment: left at a room condition for 24 h±2 h</p> |

10. Specification of Packaging

10.1 Appearance and dimensions of tape (8 mm width/paper tape)

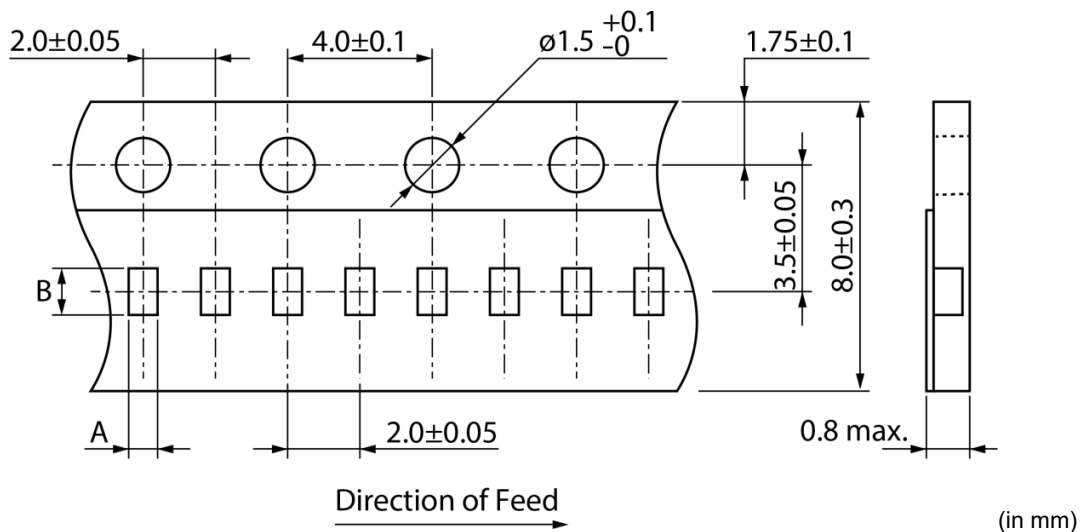

| Inductance | A* (mm) (Dimensional tolerance ± 0.03) | B* (mm) (Dimensional tolerance ± 0.03) |
|--|--|--|
| 1N5, 2N4 to 2N8, 3N9 to 4N8, 5N8 to 6N8, 8N2 to 9N9, 11N, 12N, 15N | 0.69 | 1.18 |
| 1N6 to 1N8, 2N9, 3N0, 3N1, 3N2, 4N9 to 5N1, 6N9 to 7N5, 10N, 13N, 16N to 23N, R10, R12 | 0.66 | 1.18 |
| 24N to 91N | 0.64 | 1.18 |

*Typical value

10.2 Taping specifications

| | |
|--------------------------------------|--|
| Packing quantity (Standard quantity) | 10000 pcs/reel |
| Packing method | The products are placed in embossed cavities of a base tape and sealed by a cover tape. |
| Feed hole position | The feed holes on the base tape are on the right side when the cover tape is pulled toward the user. |
| Joint | The base tape and the cover tape are seamless. |
| Number of missing products | Number of missing products within 0.025% of the number per reel or 1 pc., whichever is greater, and are not continuous. The specified quantity per reel is kept. |

10.3 Break down force of tape

| | |
|--------------------------------|----------|
| Break down force of cover tape | 5 N min. |
|--------------------------------|----------|

10.4 Peeling off force of cover tape

| | |
|----------------------|--|
| Speed of peeling off | 300 mm/min |
| Peeling off force | 0.1 N to 0.6 N (The lower limit is for typical value.) |



10.5 Dimensions of leader section, trailer section and reel

A vacant section is provided in the leader (start) section and trailer (end) section of the tape for the product. The leader section is further provided with an area consisting only of the cover tape (or top tape). (See the diagram below.)



10.6 Marking for reel

Customer part number, Murata part number, inspection number (*1), RoHS marking (*2), quantity, etc.

| | |
|----------------------------------|---|
| *1 Expression of inspection No.: | (1) Factory code (2) Date First digit: year/last digit of year Second digit: month/Jan. to Sep.→1 to 9, Oct. to Dec.→O, N, D Third, Fourth digit: day (3) Serial No. |
| *2 Expression of RoHS marking: | (1) RoHS regulation conformity (2) Murata classification number |

10.7 Marking on outer box (corrugated box)

Customer name, purchasing order number, customer part number, Murata part number, RoHS marking (*2), quantity, etc.

10.8 Specification of outer box



| Dimensions of outer box (mm) | | | Standard reel quantity in outer box (reel) |
|--|-----|----|--|
| W | D | H | |
| 186 | 186 | 93 | 5 |
| * Above outer box size is typical. It depends on a quantity of an order. | | | |

11. ⚠Caution

11.1 Restricted applications

Please contact us before using our products for the applications listed below which require especially high reliability for the prevention of defects which might directly cause damage to the third party's life, body or property.

- | | | | |
|-------------------------------|---|------------------------------|---|
| (1) Aircraft equipment | (2) Aerospace equipment | (3) Undersea equipment | (4) Power plant control equipment |
| (5) Medical equipment | (6) Transportation equipment (vehicles, trains, ships, etc.) | (7) Traffic signal equipment | (8) Disaster/crime prevention equipment |
| (9) Data-processing equipment | (10) Applications of similar complexity and/or reliability requirements to the applications listed in the above | | |

11.2 Precautions on rating

Avoid using in exceeded the rated temperature range, rated voltage, or rated current.

Usage when the ratings are exceeded could lead to wire breakage, burning, or other serious fault.

11.3 Inrush current

If an inrush current (or pulse current or rush current) that significantly exceeds the rated current is applied to the product, overheating could occur, resulting in wire breakage, burning, or other serious fault.

11.4 Corrosive gas

Please refrain from use since contact with environments with corrosive gases (sulfur gas [hydrogen sulfide, sulfur dioxide, etc.], chlorine, ammonia, etc.) or oils (cutting oil, silicone oil, etc.) that have come into contact with the previously stated corrosive gas environment will result in deterioration of product quality or an open from deterioration due to corrosion of product electrode, etc. We will not bear any responsibility for use under these environments.

12. Precautions for Use

This product is for use only with reflow soldering. It is designed to be mounted by soldering. If you want to use other mounting method, for example, using a conductive adhesive, please consult us beforehand.

Also, if repeatedly subjected to temperature cycles or other thermal stress, due to the difference in the coefficient of thermal expansion with the mounting substrate, the solder (solder fillet part) in the mounting part may crack.

The occurrence of cracks due to thermal stress is affected by the size of the land where mounted, the solder volume, and the heat dissipation of the mounting substrate. Carefully design it when a large change in ambient temperature is assumed.

12.1 Land dimensions

The following diagram shows the recommended land dimensions for reflow soldering.

The land dimensions are designed in consideration of electrical characteristics and mountability. Use of other land dimensions may preclude achievement of performance. In some cases, it may result in poor solderability, including positional shift. If you use other land pattern, consider it adequately.

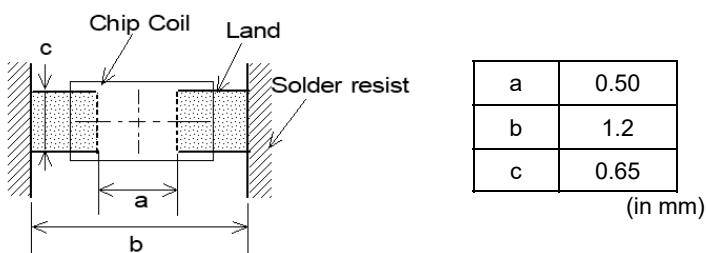

12.2 Flux and solder used

| | |
|--------|---|
| Flux | <ul style="list-style-type: none"> • Use a rosin-based flux that includes an activator with a chlorine conversion value of 0.06(wt)% to 0.1(wt)%. • Do not use a highly acidic flux with a halide content exceeding 0.2(wt)% (chlorine conversion value). • Do not use a water-soluble flux. |
| Solder | <ul style="list-style-type: none"> • Use Sn-3.0Ag-0.5Cu solder. • Standard thickness of solder paste: 100 μm to 150 μm |

If you want to use a flux other than the above, please consult our technical department.

12.3 Soldering conditions (reflow)

- Pre-heating should be in such a way that the temperature difference between solder and product surface is limited to 150°C max.
Cooling into solvent after soldering also should be in such a way that the temperature difference is limited to 100°C max.
Insufficient pre-heating may cause cracks on the product, resulting in the deterioration of product quality.
- Standard soldering profile and the limit soldering profile is as follows.
The excessive limit soldering conditions may cause leaching of the electrode and/or resulting in the deterioration of product quality.



| | Standard profile | Limit profile |
|-------------------------|--------------------------|--------------------------|
| Pre-heating | 150°C to 180°C/90 s±30 s | 150°C to 180°C/90 s±30 s |
| Heating | Above 220°C/30 s to 60 s | Above 230°C/60 s max. |
| Peak temperature | 245°C±3°C | 260°C/10 s |
| Number of reflow cycles | 2 times | 2 times |

12.4 Reworking with soldering iron

The following requirements must be met to rework a soldered product using a soldering iron.

| Item | Requirement |
|---|---------------------|
| Pre-heating | 150°C/approx. 1 min |
| Tip temperature of soldering iron | 350°C max. |
| Power consumption of soldering iron | 80 W max. |
| Tip diameter of soldering iron | ø3 mm max. |
| Soldering time | 3 s (+1 s, -0 s) |
| Number of reworking operations | 2 times max. |
| * Avoid a direct contact of the tip of the soldering iron with the product. Such a direction contact may cause cracks in the ceramic body due to thermal shock. | |

12.5 Solder volume

Solder shall be used not to increase the volume too much.



An increased solder volume increases mechanical stress on the product. Exceeding solder volume may cause the failure of mechanical or electrical performance.

12.6 Product's location

The following shall be considered when designing and laying out PCBs.

(1) PCB shall be designed so that products are not subject to mechanical stress due to warping the board.

[Products direction]

Products shall be located in the sideways direction (length: $a < b$) to the mechanical stress.



(2) Components location on PCB separation

It is effective to implement the following measures, to reduce stress in separating the board.

It is best to implement all of the following three measures; however, implement as many measures as possible to reduce stress.

| Contents of measures | Stress level |
|--|--------------|
| (1) Turn the mounting direction of the component parallel to the board separation surface. | $A > D^{*1}$ |
| (2) Add slits in the board separation part. | $A > B$ |
| (3) Keep the mounting position of the component away from the board separation surface. | $A > C$ |
| *1 $A > D$ is valid when stress is added vertically to the perforation as with hand separation. If a cutting disc is used, stress will be diagonal to the PCB, therefore $A > D$ is invalid. | |



(3) Mounting components near screw holes

When a component is mounted near a screw hole, it may be affected by the board deflection that occurs during the tightening of the screw.

Mount the component in a position as far away from the screw holes as possible.



12.7 Handling of substrate

After mounting products on a substrate, do not apply any stress to the product caused by bending or twisting to the substrate when cropping the substrate, inserting and removing a connector from the substrate or tightening screw to the substrate. Excessive mechanical stress may cause cracking in the product.



Bending

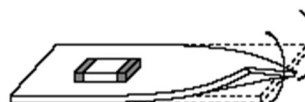

Twisting

12.8 Cleaning

The product shall be cleaned under the following conditions.

- (1) The cleaning temperature shall be 60°C max. If isopropyl alcohol (IPA) is used, the cleaning temperature shall be 40°C max.
- (2) Perform ultrasonic cleaning under the following conditions. Exercise caution to prevent resonance phenomenon in mounted products and the PCB.

| Item | Requirement |
|-----------|------------------|
| Power | 20 W/L max. |
| Time | 5 min max. |
| Frequency | 28 kHz to 40 kHz |

- (3) Cleaner

Alcohol-based cleaner: IPA

Aqueous agent: PINE ALPHA ST-100S

- (4) There shall be no residual flux or residual cleaner. When using aqueous agent, rinse the product with deionized water adequately and completely dry it so that no cleaner is left.

* For other cleaning, consult our technical department.

12.9 Storage and transportation

| | |
|--------------------|---|
| Storage period | Use the product within 12 months after delivery. If you do not use the product for more than 12 months, check solderability before using it. |
| Storage conditions | <ul style="list-style-type: none"> • The products shall be stored in a room not subject to rapid changes in temperature and humidity. The recommended temperature range is -10°C to +40°C. The recommended relative humidity range is 15% to 85%. • Keeping the product in corrosive gases, such as sulfur, chlorine gas or acid, oxidizes the electrode, resulting in poor solderability or corrosion of the coil wire of the product. • Do not keep products in bulk packaging. Doing so may cause collision between the products or between the products and other products, resulting in core chipping or wire breakage. • Do not place the products directly on the floor; they should be placed on a palette so that they are not affected by humidity or dust. • Avoid keeping the products in a place exposed to direct sunlight, heat or vibration. |
| Transportation | Excessive vibration and impact reduces the reliability of the products. Exercise caution when handling the products. |

12.10 Resin coating

The inductance value may change due to high cure-stress of resin to be used for coating/molding products.

A wire breakage issue may occur by mechanical stress caused by the resin, amount/cured shape of resin, or operating condition etc. Some resin contains some impurities or chloride possible to generate chlorine by hydrolysis under some operating condition may cause corrosion of wire of coil, leading to wire breakage.

So, please pay your careful attention when you select resin in case of coating/molding the products with the resin.

Prior to use the coating resin, please make sure no reliability issue is observed by evaluating products mounted on your board.

12.11 Handling of product

- Sharp material such as a pair of tweezers or other material such as bristles of cleaning brush, shall not be touched to the winding portion to prevent the breaking of wire.
- Mechanical shock should not be applied to the products mounted on the board to prevent the breaking of the core.

12.12 Handling with mounting equipment

- With some types of mounting equipment, a support pin pushes up the product from the bottom of the base (paper) tape when the product is sucked with the pick-up nozzle.
When using this type of equipment, detach the support pin to prevent the breaking of wire on the product.
- In some cases, the laser recognition function of the mounting equipment may not recognize this product correctly. Please contact us when using laser recognition. (There is no problem with the permeation and reflection type.)

13. Note

- (1) Please make sure that your product has been evaluated in view of your specifications with our product being mounted to your product.
- (2) You are requested not to use our product deviating from the reference specifications.
- (3) The contents of this reference specification are subject to change without advance notice. Please approve our product specifications or transact the approval sheet for product specifications before ordering.

14. Appendix

Electrical performance: Measuring method for inductance/Q (Q measurement is applicable only when the Q value is included in the rating table.)

Perform measurement using the method described below. (Perform correction for the error deriving from the measuring terminal.)

(1) Residual elements and stray elements of the measuring terminal can be expressed by the F parameter for the 2-pole terminal as shown in the figure below.

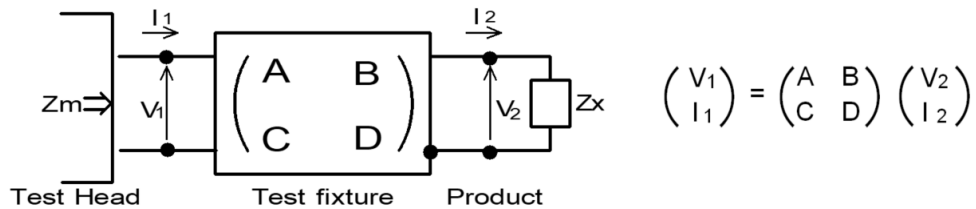

(2) The product's impedance value (Zx) and measured impedance value (Zm) can be expressed as shown below, by using the respective current and voltage for input/output.

$$Z_m = \frac{V_1}{I_1} \quad Z_x = \frac{V_2}{I_2}$$

(3) Thus, the relationship between the product's impedance value (Zx) and measured impedance value (Zm) is as follows.



| | |
|---|--|
| $Z_x = \alpha \frac{Z_m - \beta}{1 - Z_m \Gamma}$ | <p>Here,</p> <p>$\alpha = D/A = 1$</p> <p>$\beta = B/D = Z_{sm} - (1 - Y_{om} Z_{sm}) Z_{ss}$</p> <p>$\Gamma = C/A = Y_{om}$</p> <p>Zsm: measured impedance of short chip Zss: residual impedance of short chip (0.556 nH) Yom: measured admittance when measuring terminal is open</p> |
|---|--|

(4) Calculate inductance Lx and Qx using the equations shown below.

| | |
|---|-----------------------------|
| $L_x = \frac{\text{Im}(Z_x)}{2\pi f}$ | Lx: inductance of chip coil |
| $Q_x = \frac{\text{Im}(Z_x)}{\text{Re}(Z_x)}$ | Qx: Q of chip coil |
| | f: measuring frequency |

Looking for pricing, stock, or lifecycle information?

Click below to explore more details on WIN SOURCE:

-  [View LQW15AN3N2B00D on WIN SOURCE](#)
-  [Murata Electronics North America Information](#)

Optimize Your Supply Chain with WIN SOURCE Solutions

-  Global Sourcing Solution
-  Obsolete Management
-  Cost Control Management
-  Shortage Management
-  Alternative Solution
-  Excess Inventory Management