



**THE DATASHEET OF
NJVMJD112T4G**



Complementary Darlington Power Transistors

DPAK For Surface Mount Applications

MJD112 (NPN), MJD117 (PNP)

Designed for general purpose power and switching such as output or driver stages in applications such as switching regulators, converters, and power amplifiers.

Features

- Lead Formed for Surface Mount Applications in Plastic Sleeves (No Suffix)
- Straight Lead Version in Plastic Sleeves (“-1” Suffix)
- Electrically Similar to Popular TIP31 and TIP32 Series
- NJV Prefix for Automotive and Other Applications Requiring Unique Site and Control Change Requirements; AEC-Q101 Qualified and PPAP Capable
- These Devices are Pb-Free and are RoHS Compliant*

SILICON
 POWER TRANSISTORS
 2 AMPERES
 100 VOLTS, 20 WATTS

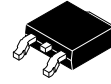

DPAK
CASE 369C

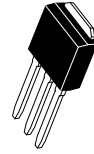

DPAK-3
CASE 369D

MARKING DIAGRAMS

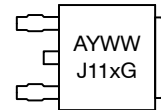

DPAK

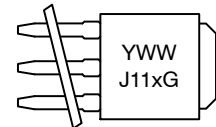

DPAK-3

- A = Assembly Location
- Y = Year
- WW = Work Week
- x = 2 or 7
- G = Pb-Free Package

ORDERING INFORMATION

See detailed ordering and shipping information in the package dimensions section on page 8 of this data sheet.

*For additional information on our Pb-Free strategy and soldering details, please download the **onsemi** Soldering and Mounting Techniques Reference Manual, SOLDERRM/D.

MJD112 (NPN), MJD117 (PNP)

MAXIMUM RATINGS

Rating	Symbol	Max	Unit
Collector–Emitter Voltage	V_{CEO}	100	Vdc
Collector–Base Voltage	V_{CB}	100	Vdc
Emitter–Base Voltage	V_{EB}	5	Vdc
Collector Current Continuous Peak	I_C	2 4	Adc
Base Current	I_B	50	mAdc
Total Power Dissipation @ $T_C = 25^\circ\text{C}$ Derate above 25°C	P_D	20 0.16	W W/ $^\circ\text{C}$
Total Power Dissipation (Note1) @ $T_A = 25^\circ\text{C}$ Derate above 25°C	P_D	1.75 0.014	W W/ $^\circ\text{C}$
Operating and Storage Junction Temperature Range	T_J, T_{stg}	–65 to +150	$^\circ\text{C}$

Stresses exceeding those listed in the Maximum Ratings table may damage the device. If any of these limits are exceeded, device functionality should not be assumed, damage may occur and reliability may be affected.

THERMAL CHARACTERISTICS

Characteristic	Symbol	Max	Unit
Thermal Resistance, Junction–to–Case	$R_{\theta JC}$	6.25	$^\circ\text{C}/\text{W}$
Thermal Resistance, Junction–to–Ambient (Note 1)	$R_{\theta JA}$	71.4	$^\circ\text{C}/\text{W}$

1. These ratings are applicable when surface mounted on the minimum pad sizes recommended.

MJD112 (NPN), MJD117 (PNP)

ELECTRICAL CHARACTERISTICS (T_C = 25°C unless otherwise noted)

Characteristic	Symbol	Min	Max	Unit
OFF CHARACTERISTICS				
Collector–Emitter Sustaining Voltage (Note 2) (I _C = 30 mA _{dc} , I _B = 0)	V _{CEO(sus)}	100	–	V _{dc}
Collector Cutoff Current (V _{CE} = 50 V _{dc} , I _B = 0)	I _{CEO}	–	20	μA _{dc}
Collector Cutoff Current (V _{CB} = 100 V _{dc} , I _E = 0)	I _{CBO}	–	20	μA _{dc}
Emitter Cutoff Current (V _{BE} = 5 V _{dc} , I _C = 0)	I _{EBO}	–	2	mA _{dc}
Collector–Cutoff Current (V _{CB} = 80 V _{dc} , I _E = 0)	I _{CBO}	–	10	μA _{dc}
Emitter–Cutoff Current (V _{BE} = 5 V _{dc} , I _C = 0)	I _{EBO}	–	2	mA _{dc}
ON CHARACTERISTICS				
DC Current Gain (I _C = 0.5 A _{dc} , V _{CE} = 3 V _{dc}) (I _C = 2 A _{dc} , V _{CE} = 3 V _{dc}) (I _C = 4 A _{dc} , V _{CE} = 3 V _{dc})	h _{FE}	500 1000 200	– 12,000 –	–
Collector–Emitter Saturation Voltage (I _C = 2 A _{dc} , I _B = 8 mA _{dc}) (I _C = 4 A _{dc} , I _B = 40 mA _{dc})	V _{CE(sat)}	– –	2 3	V _{dc}
Base–Emitter Saturation Voltage (I _C = 4 A _{dc} , I _B = 40 mA _{dc})	V _{BE(sat)}	–	4	V _{dc}
Base–Emitter On Voltage (I _C = 2 A _{dc} , V _{CE} = 3 V _{dc})	V _{BE(on)}	–	2.8	V _{dc}
DYNAMIC CHARACTERISTICS				
Current–Gain – Bandwidth Product (I _C = 0.75 A _{dc} , V _{CE} = 10 V _{dc} , f = 1 MHz)	f _T	25	–	MHz
Output Capacitance (V _{CB} = 10 V _{dc} , I _E = 0, f = 0.1 MHz) MJD117, NJVMJD117T4G MJD112, NJVMJD112G, NJVMJD112T4G	C _{ob}	– –	200 100	pF

2. Pulse Test: Pulse Width ≤ 300 μs, Duty Cycle ≤ 2%.

*These ratings are applicable when surface mounted on the minimum pad sizes recommended.

MJD112 (NPN), MJD117 (PNP)

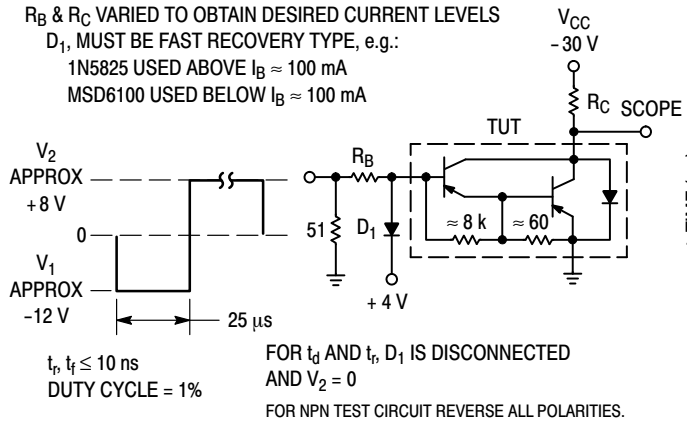

Figure 1. Switching Times Test Circuit

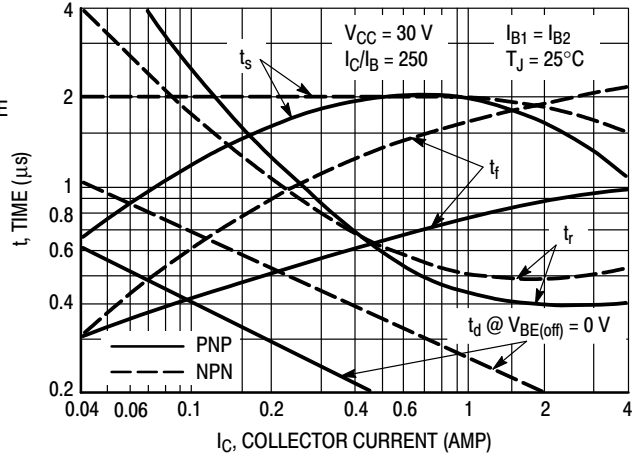

Figure 2. Switching Times

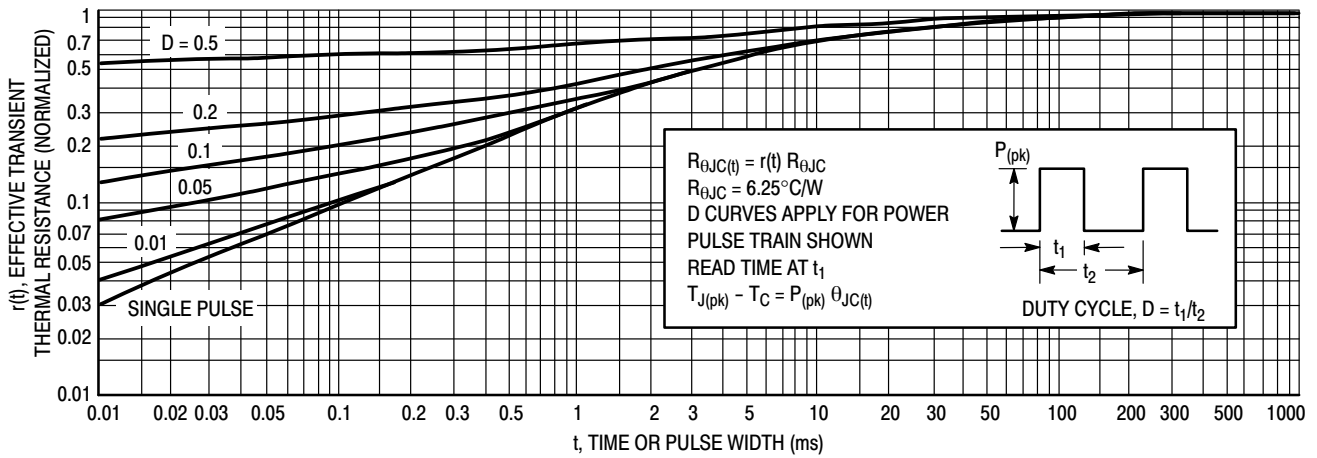

Figure 3. Thermal Response

MJD112 (NPN), MJD117 (PNP)

ACTIVE-REGION SAFE-OPERATING AREA

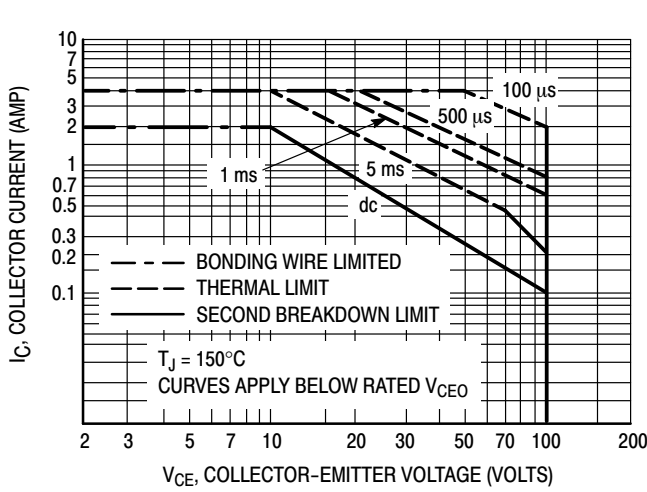

Figure 4. Maximum Rated Forward Biased Safe Operating Area

There are two limitations on the power handling ability of a transistor: average junction temperature and second breakdown. Safe operating area curves indicate $I_C - V_{CE}$ limits of the transistor that must be observed for reliable operation; i.e., the transistor must not be subjected to greater dissipation than the curves indicate.

The data of Figures 5 and 6 is based on $T_{J(pk)} = 150^\circ\text{C}$; T_C is variable depending on conditions. Second breakdown pulse limits are valid for duty cycles to 10% provided $T_{J(pk)} < 150^\circ\text{C}$. $T_{J(pk)}$ may be calculated from the data in Figure 4. At high case temperatures, thermal limitations will reduce the power that can be handled to values less than the limitations imposed by second breakdown.

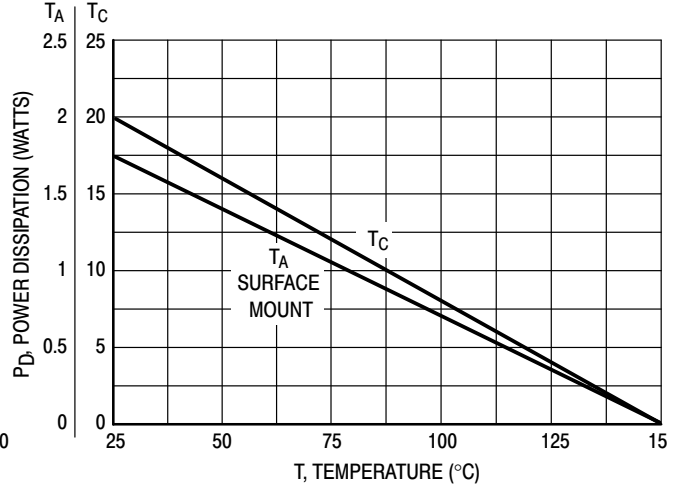

Figure 5. Power Derating

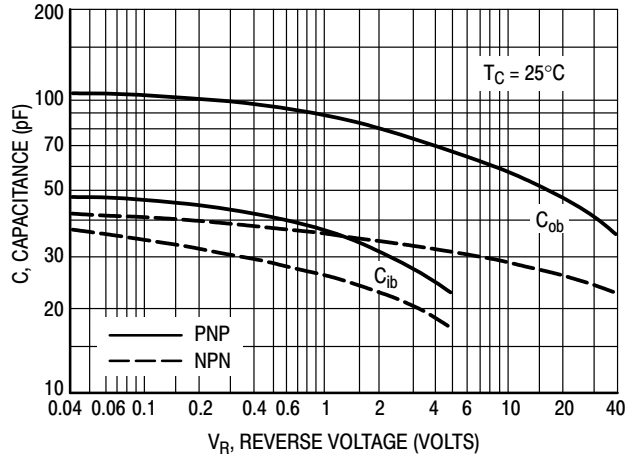

Figure 6. Capacitance

MJD112 (NPN), MJD117 (PNP)

TYPICAL ELECTRICAL CHARACTERISTICS

NPN MJD112

PNP MJD117

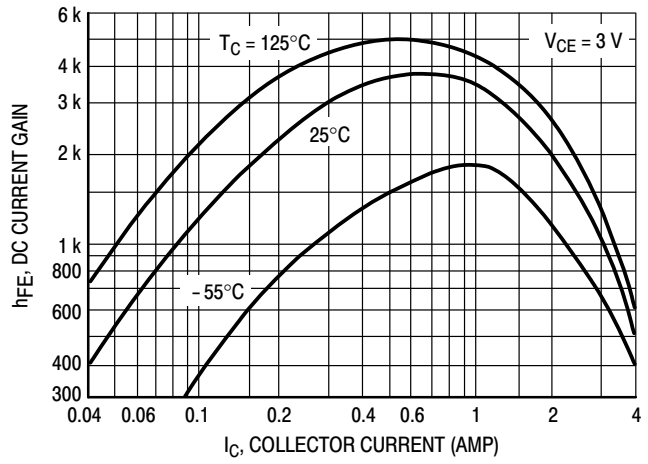
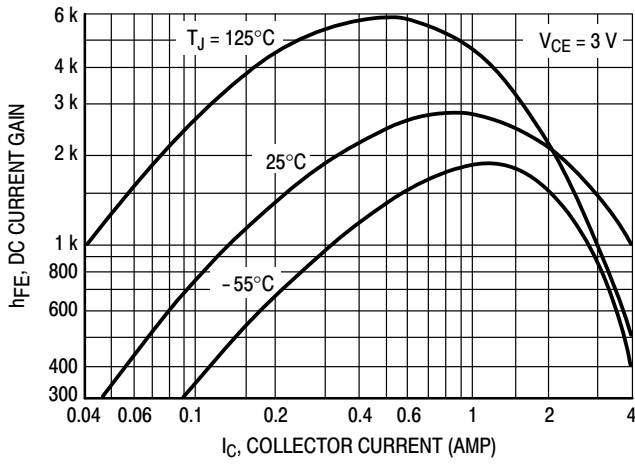

Figure 7. DC Current Gain

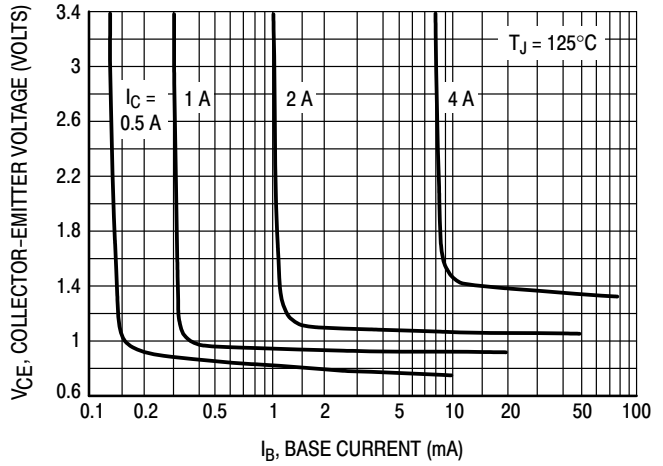
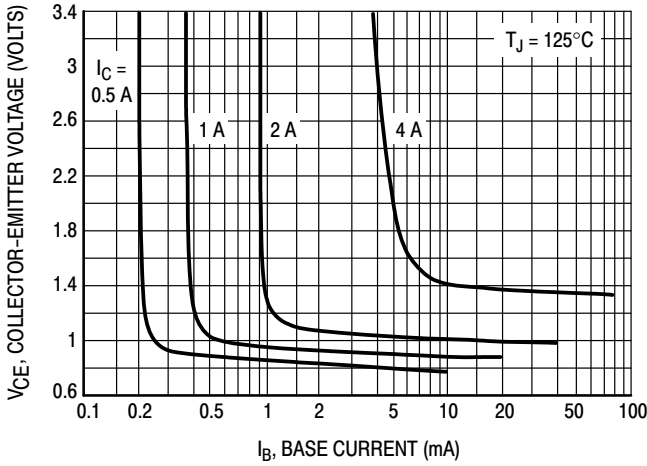

Figure 8. Collector Saturation Region

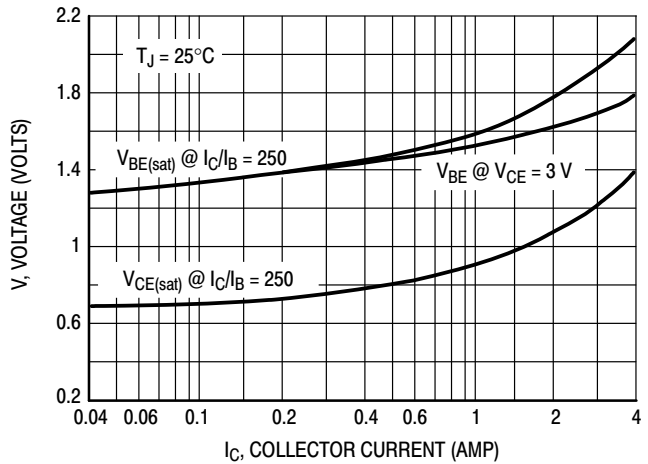
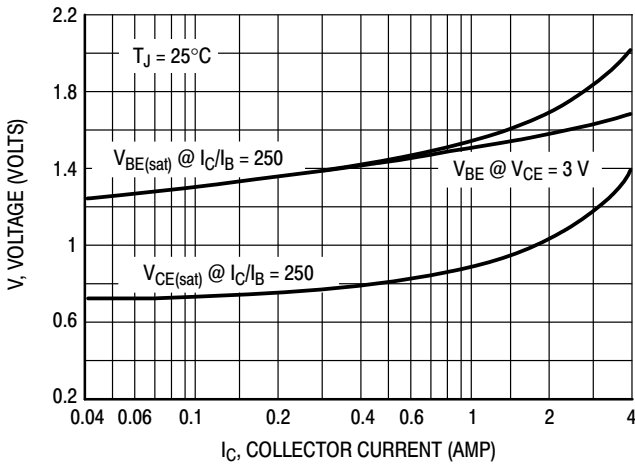

Figure 9. "On Voltages"

MJD112 (NPN), MJD117 (PNP)

NPN MJD112

PNP MJD117

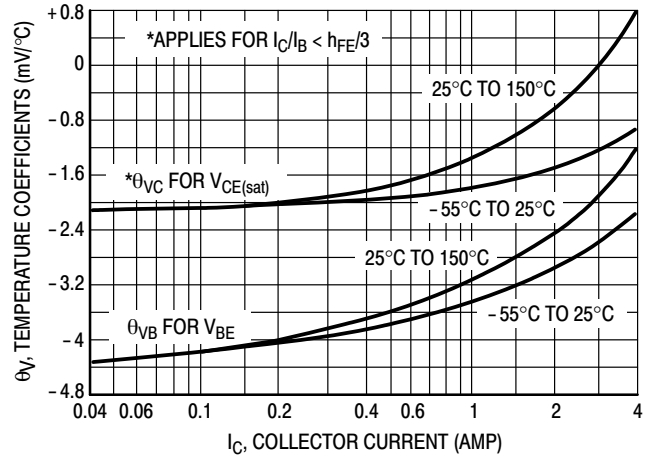
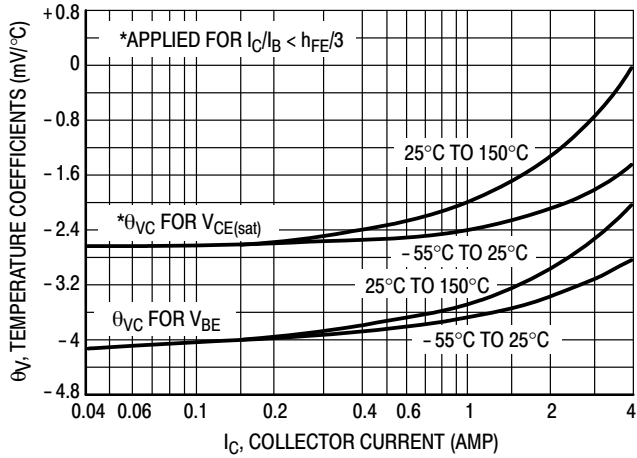

Figure 10. Temperature Coefficients

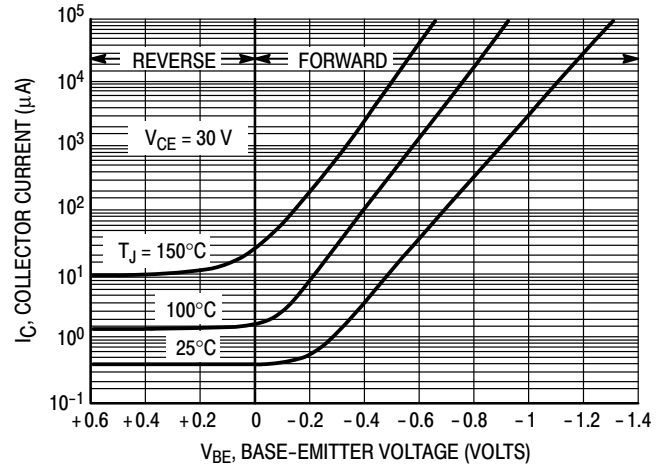
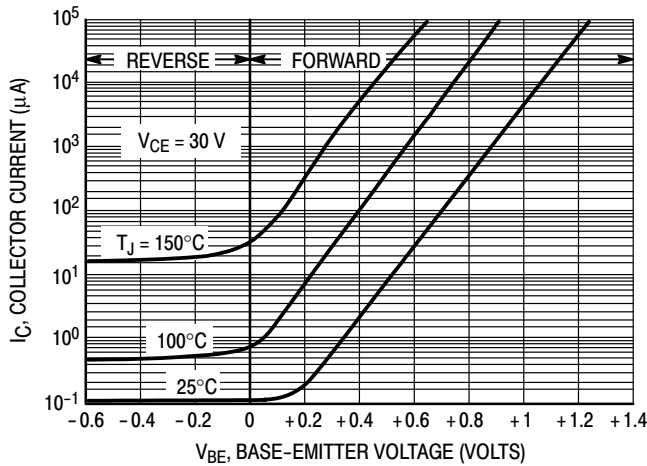

Figure 11. Collector Cut-Off Region

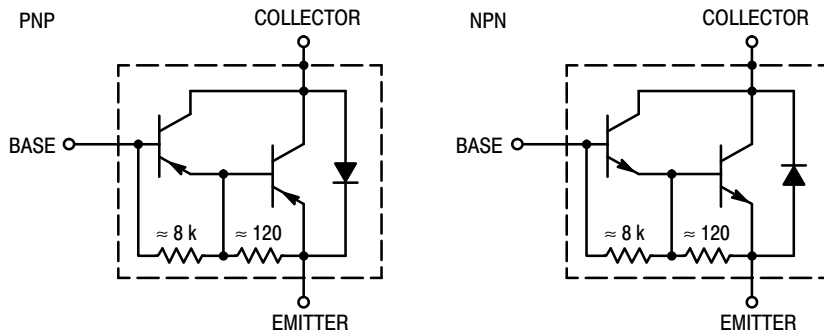

Figure 12. Darlington Schematic

MJD112 (NPN), MJD117 (PNP)

ORDERING INFORMATION

Device	Package Type	Package	Shipping [†]
MJD112G	DPAK (Pb-Free)	369C	75 Units / Rail
NJVMJD112G*	DPAK (Pb-Free)	369C	75 Units / Rail
MJD112-1G	DPAK-3 (Pb-Free)	369D	75 Units / Rail
MJD112RLG	DPAK (Pb-Free)	369C	1,800 Tape & Reel
MJD112T4G	DPAK (Pb-Free)	369C	2,500 Tape & Reel
NJVMJD112T4G*	DPAK (Pb-Free)	369C	2,500 Tape & Reel
MJD117G	DPAK (Pb-Free)	369C	75 Units / Rail
MJD117-1G	DPAK-3 (Pb-Free)	369D	75 Units / Rail
MJD117RLG	DPAK (Pb-Free)	369C	1,800 Tape & Reel
MJD117T4G	DPAK (Pb-Free)	369C	2,500 Tape & Reel
NJVMJD117T4G*	DPAK (Pb-Free)	369C	2,500 Tape & Reel

[†]For information on tape and reel specifications, including part orientation and tape sizes, please refer to our Tape and Reel Packaging Specifications Brochure, BRD8011/D.

*NJV Prefix for Automotive and Other Applications Requiring Unique Site and Control Change Requirements; AEC-Q101 Qualified and PPAP Capable.

MJD112 (NPN), MJD117 (PNP)

PACKAGE DIMENSIONS

DPAK (SINGLE GAUGE) CASE 369C ISSUE F

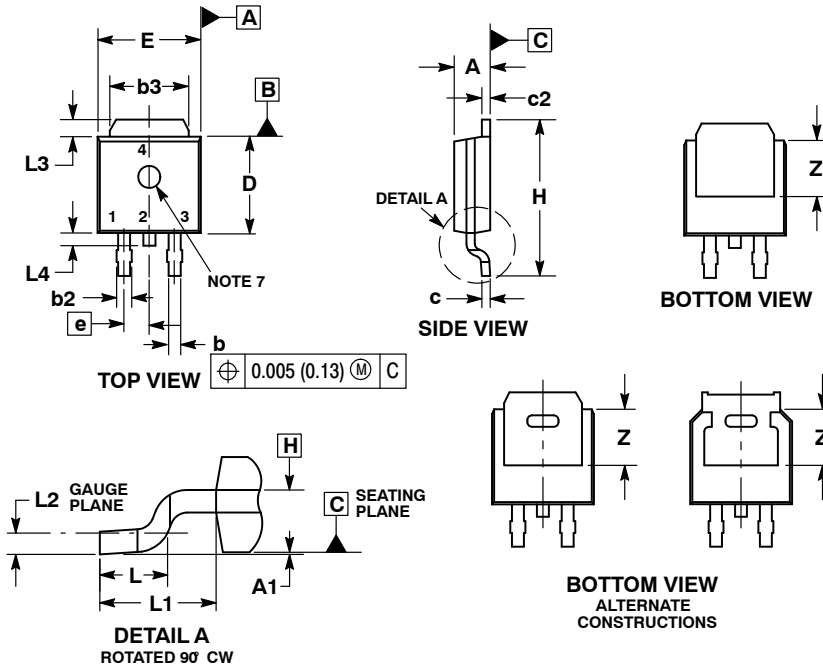

NOTES:

1. DIMENSIONING AND TOLERANCING PER ASME Y14.5M, 1994.
2. CONTROLLING DIMENSION: INCHES.
3. THERMAL PAD CONTOUR OPTIONAL WITHIN DIMENSIONS b3, L3 and Z.
4. DIMENSIONS D AND E DO NOT INCLUDE MOLD FLASH, PROTRUSIONS, OR BURRS. MOLD FLASH, PROTRUSIONS, OR GATE BURRS SHALL NOT EXCEED 0.006 INCHES PER SIDE.
5. DIMENSIONS D AND E ARE DETERMINED AT THE OUTERMOST EXTREMES OF THE PLASTIC BODY.
6. DATUMS A AND B ARE DETERMINED AT DATUM PLANE H.
7. OPTIONAL MOLD FEATURE.

DIM	INCHES		MILLIMETERS	
	MIN	MAX	MIN	MAX
A	0.086	0.094	2.18	2.38
A1	0.000	0.005	0.00	0.13
b	0.025	0.035	0.63	0.89
b2	0.028	0.045	0.72	1.14
b3	0.180	0.215	4.57	5.46
c	0.018	0.024	0.46	0.61
c2	0.018	0.024	0.46	0.61
D	0.235	0.245	5.97	6.22
E	0.250	0.265	6.35	6.73
e	0.090 BSC		2.29 BSC	
H	0.370	0.410	9.40	10.41
L	0.055	0.070	1.40	1.78
L1	0.114 REF		2.90 REF	
L2	0.020 BSC		0.51 BSC	
L3	0.035	0.050	0.89	1.27
L4	---	0.040	---	1.01
Z	0.155	---	3.93	---

- STYLE 1:
PIN 1. BASE
2. COLLECTOR
3. EMITTER
4. COLLECTOR

SOLDERING FOOTPRINT*

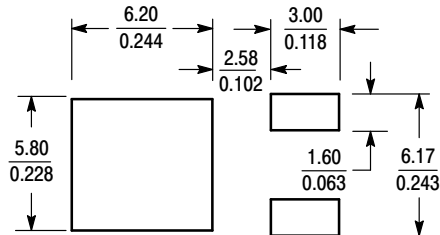

SCALE 3:1 $\left(\frac{\text{mm}}{\text{inches}} \right)$

*For additional information on our Pb-Free strategy and soldering details, please download the **onsemi** Soldering and Mounting Techniques Reference Manual, SOLDERRM/D.

MJD112 (NPN), MJD117 (PNP)

PACKAGE DIMENSIONS

IPAK CASE 369D ISSUE C

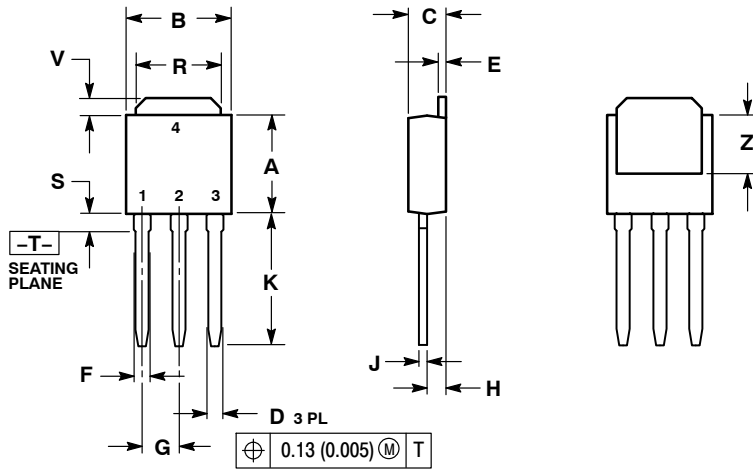

NOTES:

1. DIMENSIONING AND TOLERANCING PER ANSI Y14.5M, 1982.
2. CONTROLLING DIMENSION: INCH.

DIM	INCHES		MILLIMETERS	
	MIN	MAX	MIN	MAX
A	0.235	0.245	5.97	6.35
B	0.250	0.265	6.35	6.73
C	0.086	0.094	2.19	2.38
D	0.027	0.035	0.69	0.88
E	0.018	0.023	0.46	0.58
F	0.037	0.045	0.94	1.14
G	0.090 BSC		2.29 BSC	
H	0.034	0.040	0.87	1.01
J	0.018	0.023	0.46	0.58
K	0.350	0.380	8.89	9.65
R	0.180	0.215	4.45	5.45
S	0.025	0.040	0.63	1.01
V	0.035	0.050	0.89	1.27
Z	0.155	---	3.93	---

STYLE 1:

- PIN 1. BASE
2. COLLECTOR
3. EMITTER
4. COLLECTOR

onsemi, **onsemi**, and other names, marks, and brands are registered and/or common law trademarks of Semiconductor Components Industries, LLC dba "onsemi" or its affiliates and/or subsidiaries in the United States and/or other countries. onsemi owns the rights to a number of patents, trademarks, copyrights, trade secrets, and other intellectual property. A listing of onsemi's product/patent coverage may be accessed at www.onsemi.com/site/pdf/Patent-Marketing.pdf. onsemi reserves the right to make changes at any time to any products or information herein, without notice. The information herein is provided "as-is" and onsemi makes no warranty, representation or guarantee regarding the accuracy of the information, product features, availability, functionality, or suitability of its products for any particular purpose, nor does onsemi assume any liability arising out of the application or use of any product or circuit, and specifically disclaims any and all liability, including without limitation special, consequential or incidental damages. Buyer is responsible for its products and applications using onsemi products, including compliance with all laws, regulations and safety requirements or standards, regardless of any support or applications information provided by onsemi. "Typical" parameters which may be provided in onsemi data sheets and/or specifications can and do vary in different applications and actual performance may vary over time. All operating parameters, including "Typicals" must be validated for each customer application by customer's technical experts. onsemi does not convey any license under any of its intellectual property rights nor the rights of others. onsemi products are not designed, intended, or authorized for use as a critical component in life support systems or any FDA Class 3 medical devices or medical devices with a same or similar classification in a foreign jurisdiction or any devices intended for implantation in the human body. Should Buyer purchase or use onsemi products for any such unintended or unauthorized application, Buyer shall indemnify and hold onsemi and its officers, employees, subsidiaries, affiliates, and distributors harmless against all claims, costs, damages, and expenses, and reasonable attorney fees arising out of, directly or indirectly, any claim of personal injury or death associated with such unintended or unauthorized use, even if such claim alleges that onsemi was negligent regarding the design or manufacture of the part. onsemi is an Equal Opportunity/Affirmative Action Employer. This literature is subject to all applicable copyright laws and is not for resale in any manner.

PUBLICATION ORDERING INFORMATION

LITERATURE FULFILLMENT:
Email Requests to: orderlit@onsemi.com

onsemi Website: www.onsemi.com

TECHNICAL SUPPORT
North American Technical Support:
Voice Mail: 1 800-282-9855 Toll Free USA/Canada
Phone: 011 421 33 790 2910

Europe, Middle East and Africa Technical Support:
Phone: 00421 33 790 2910
For additional information, please contact your local Sales Representative

Looking for pricing, stock, or lifecycle information?

Click below to explore more details on WIN SOURCE:

 [View NJVMJD112T4G](#) on WIN SOURCE

 [ON Semiconductor](#) Information

Optimize Your Supply Chain with WIN SOURCE Solutions

-  Global Sourcing Solution
-  Obsolete Management
-  Cost Control Management
-  Shortage Management
-  Alternative Solution
-  Excess Inventory Management