

CM1442

LCD and Camera EMI Filter Array with ESD Protection

Product Description

The CM1442 is a family of pi-style EMI filter arrays with ESD protection, which integrates six and eight filters (C-R-C) in Chip Scale Package form factor with 0.40 mm pitch. The CM1442 has component values of 15 pF – 100 Ω – 15 pF per channel. The CM1442 has a cut-off frequency of 120 MHz and can be used in applications where the data rates are as high as 48 Mbps. The parts include avalanche-type ESD diodes on every pin, which provide a very high level of protection for sensitive electronic components that may be subjected to electrostatic discharge (ESD). The ESD protection diodes safely dissipate ESD strikes of ±15 kV, well beyond the maximum requirement of the IEC61000-4-2 international standard. Using the MIL-STD-883 (Method 3015) specification for Human Body Model (HBM) ESD, the pins are protected for contact discharges at greater than ±30 kV.

This device is particularly well suited for portable electronics (e.g. wireless handsets, PDAs, notebook computers) because of its small package format and easy-to-use pin assignments. In particular, the CM1442 is ideal for EMI filtering and protecting data and control lines for the I/O data ports, LCD display and camera interface in mobile handsets.

The CM1442 incorporates *OptiGuard™* which results in improved reliability at assembly. The CM1442 is available in a space-saving, low-profile Chip Scale Package with RoHS compliant lead-free finishing. It is manufactured with a 0.40 mm pitch and 0.25 mm CSP solder ball to provide up to 28% board space saving versus competing CSP devices with 0.50 mm pitch and 0.30 mm CSP solder ball.

Features

- Six and Eight Channels of EMI Filtering with Integrated ESD Protection
- 0.4 mm Pitch, 15-Bump, 2.360 mm x 1.053 mm Footprint Chip Scale Package (CM1442-06)
- 0.4 mm Pitch, 20-Bump, 3.160 mm x 1.053 mm Footprint Chip Scale Package (CM1442-08)
- Pi-Style EMI Filters in a Capacitor-Resistor-Capacitor (C-R-C) Network
- ±15 kV ESD Protection on Each Channel (IEC 61000-4-2 Level 4, Contact Discharge)
- ±30 kV ESD Protection on Each Channel (HBM)
- These Devices are Pb-Free and are RoHS Compliant

Applications

- LCD and Camera Data Lines in Mobile Handsets
- I/O Port Protection for Mobile Handsets, Notebook Computers, PDAs, etc.
- Wireless Handsets



ON Semiconductor®

<http://onsemi.com>



WLCSP15
CP SUFFIX
CASE 567BP



WLCSP20
CP SUFFIX
CASE 567BU

MARKING DIAGRAM

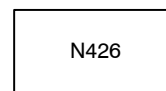

CM1442-06
15-Bump CSP Package

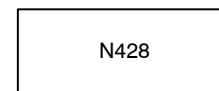

CM1442-08
20-Bump CSP Package

N426 = CM1442-06CP
N428 = CM1442-08CP

ORDERING INFORMATION

Device	Package	Shipping†
CM1442-06CP	CSP-15 (Pb-Free)	3500/Tape & Reel
CM1442-08CP	CSP-20 (Pb-Free)	3500/Tape & Reel

†For information on tape and reel specifications, including part orientation and tape sizes, please refer to our Tape and Reel Packaging Specification Brochure, BRD8011/D.

- Greater than 30 dB Attenuation (Typical) at 1 GHz
- Chip Scale Package Features Extremely Low Lead Inductance for Optimum Filter and ESD Performance
- *OptiGuard™* Coated for Improved Reliability at Assembly
- EMI Filtering for Data Ports in Cell Phones, PDAs or Notebook Computers
- Handheld PCs/PDAs
- LCD and Camera Modules

CM1442

BLOCK DIAGRAM

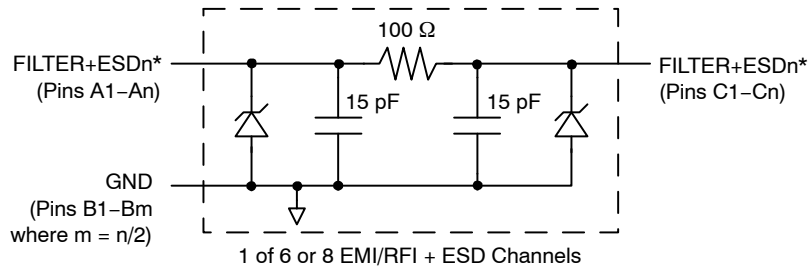

*See Package/Pinout Diagrams for expanded pin information.

PACKAGE / PINOUT DIAGRAMS

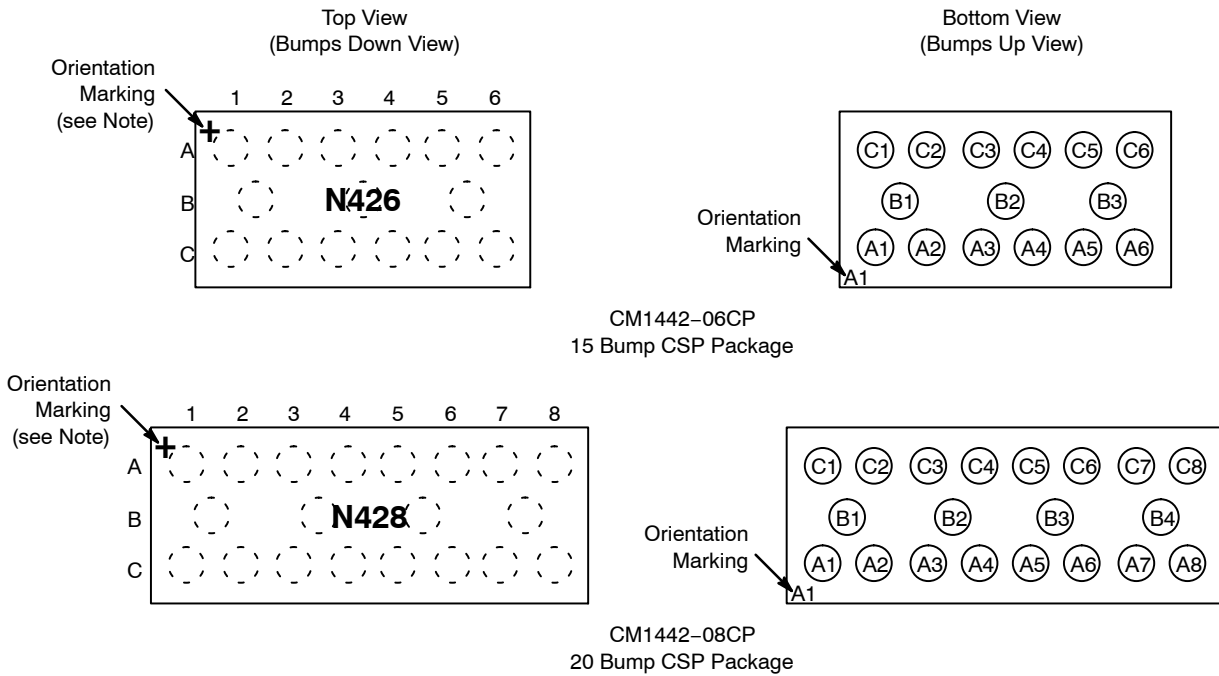

Note: Lead-free devices are specified by using a "+" character for the top side orientation mark.

Table 1. PIN DESCRIPTIONS

Pins	Name	Description	Pins	Name	Description
A1	FILTER1	Filter + ESD Channel 1	C1	FILTER1	Filter + ESD Channel 1
A2	FILTER2	Filter + ESD Channel 2	C2	FILTER2	Filter + ESD Channel 2
A3	FILTER3	Filter + ESD Channel 3	C3	FILTER3	Filter + ESD Channel 3
A4	FILTER4	Filter + ESD Channel 4	C4	FILTER4	Filter + ESD Channel 4
A5	FILTER5	Filter + ESD Channel 5	C5	FILTER5	Filter + ESD Channel 5
A6	FILTER6	Filter + ESD Channel 6	C6	FILTER6	Filter + ESD Channel 6
A7	FILTER7	Filter + ESD Channel 7	C7	FILTER7	Filter + ESD Channel 7
A8	FILTER8	Filter + ESD Channel 8	C8	FILTER8	Filter + ESD Channel 8
B1-B4	GND	Device Ground			

CM1442

SPECIFICATIONS

Table 2. ABSOLUTE MAXIMUM RATINGS

Parameter	Rating	Units
Storage Temperature Range	-65 to +150	°C
DC Power per Resistor	100	mW
DC Package Power Rating	500	mW

Stresses exceeding Maximum Ratings may damage the device. Maximum Ratings are stress ratings only. Functional operation above the Recommended Operating Conditions is not implied. Extended exposure to stresses above the Recommended Operating Conditions may affect device reliability.

Table 3. STANDARD OPERATING CONDITIONS

Parameter	Rating	Units
Operating Temperature Range	-40 to +85	°C

Table 4. ELECTRICAL OPERATING CHARACTERISTICS (Note 1)

Symbol	Parameter	Conditions	Min	Typ	Max	Units
R	Resistance		80	100	120	Ω
C _{TOTAL}	Total Channel Capacitance	At 2.5 VDC Reverse Bias, 1 MHz, 30 mVAC	24	30	36	pF
C	Capacitance C1	At 2.5 VDC Reverse Bias, 1 MHz, 30 mVAC	12	15	18	pF
V _{DIODE}	Standoff Voltage	I _{DIODE} = 10 μA		6.0		V
I _{LEAK}	Diode Leakage Current (reverse bias)	V _{DIODE} = 3.3 V		0.1	1	μA
V _{SIG}	Signal Clamp Voltage Positive Clamp Negative Clamp	I _{LOAD} = 10 mA I _{LOAD} = -10 mA	5.6 -1.5	6.8 -0.8	9.0 -0.4	V
V _{ESD}	In-system ESD Withstand Voltage a) Human Body Model, MIL-STD-883, Method 3015 b) Contact Discharge per IEC 61000-4-2 Level 4	(Notes 2 and 3)	±30 ±15			kV
R _{DYN}	Dynamic Resistance Positive Negative			2.3 0.9		Ω
f _C	Cut-off Frequency Z _{SOURCE} = 50 Ω, Z _{LOAD} = 50 Ω	R = 100 Ω, C = 15 pF		115		MHz

1. T_A = 25°C unless otherwise specified.
2. ESD applied to input and output pins with respect to GND, one at a time.
3. Unused pins are left open.

CM1442

PERFORMANCE INFORMATION

Typical Filter Performance ($T_A = 25^\circ\text{C}$, DC Bias = 0 V, 50 Ω Environment)

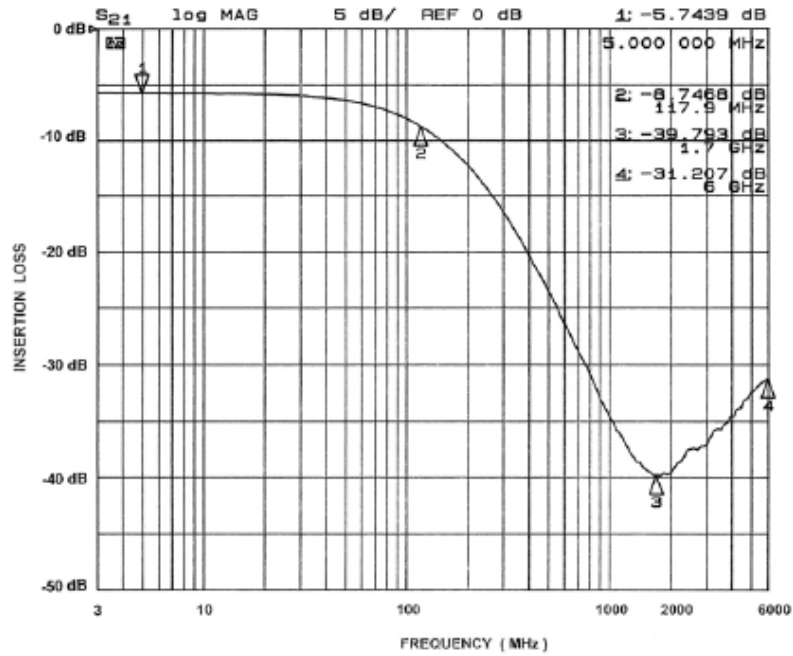

Figure 1. Insertion Loss vs. Frequency (A1-C1 to GND B1)

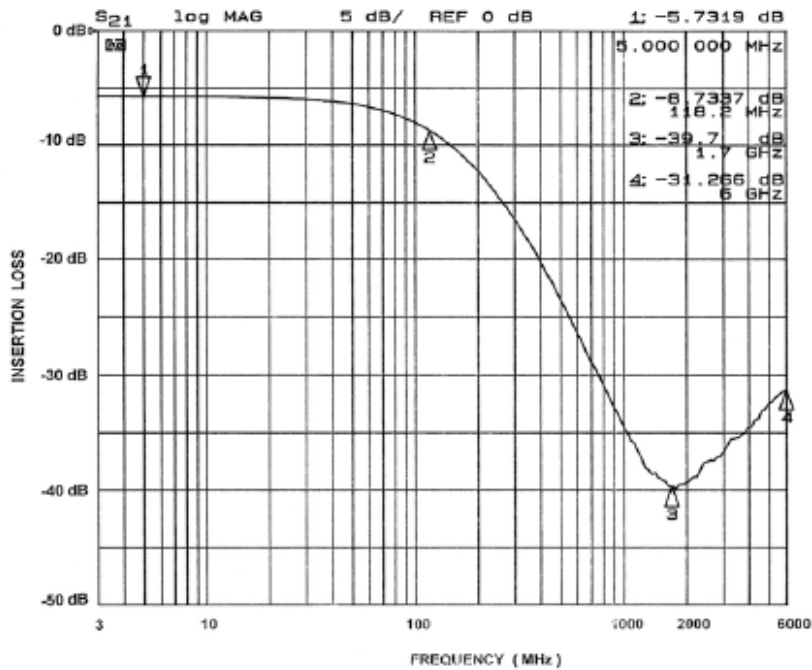

Figure 2. Insertion Loss vs. Frequency (A2-C2 to GND B1)

PERFORMANCE INFORMATION (Cont'd)

Typical Filter Performance ($T_A = 25^\circ\text{C}$, DC Bias = 0 V, 50 Ω Environment)

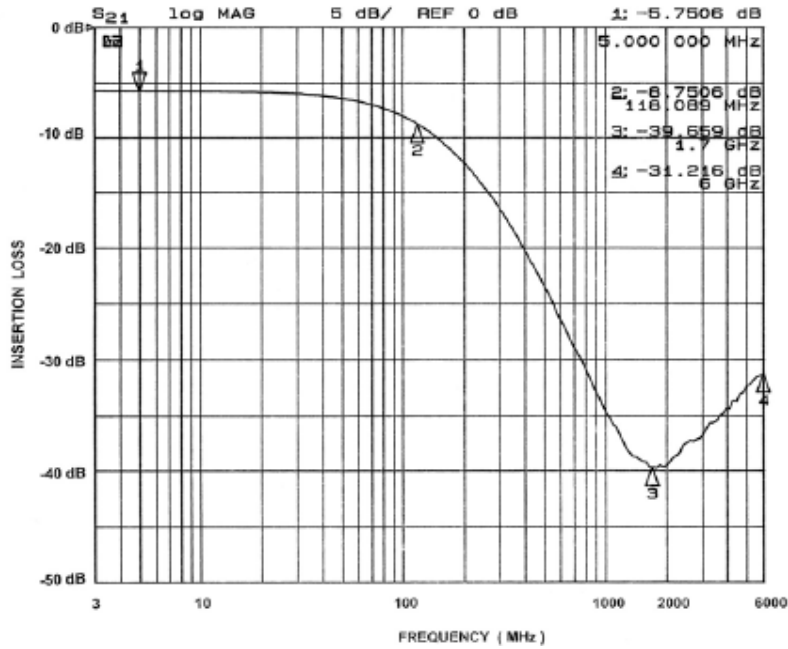

Figure 3. Insertion Loss vs. Frequency (A3-C3 to GND B2)

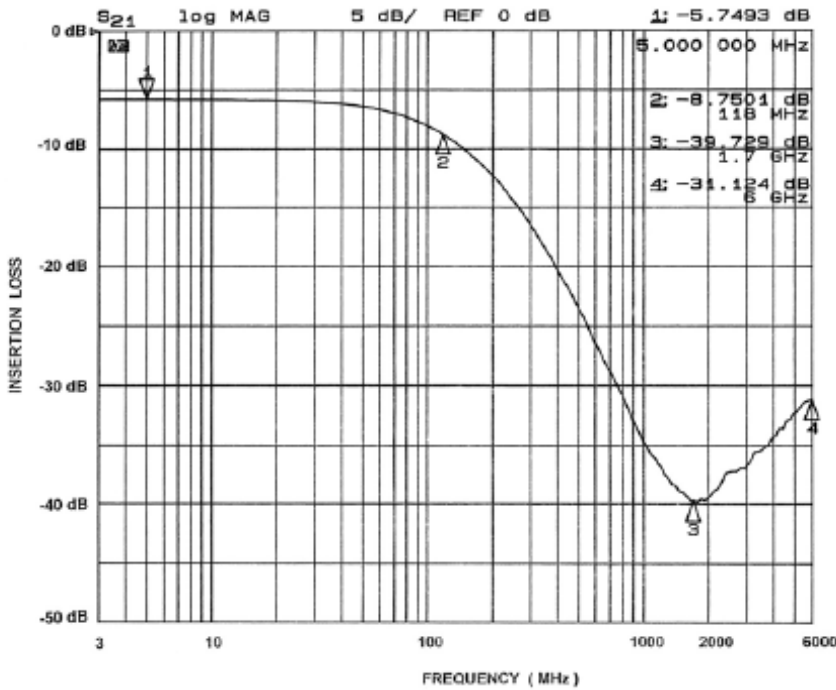

Figure 4. Insertion Loss vs. Frequency (A4-C4 to GND B2)

CM1442

PERFORMANCE INFORMATION (Cont'd)

Typical Filter Performance ($T_A = 25^\circ\text{C}$, DC Bias = 0 V, 50 Ω Environment)

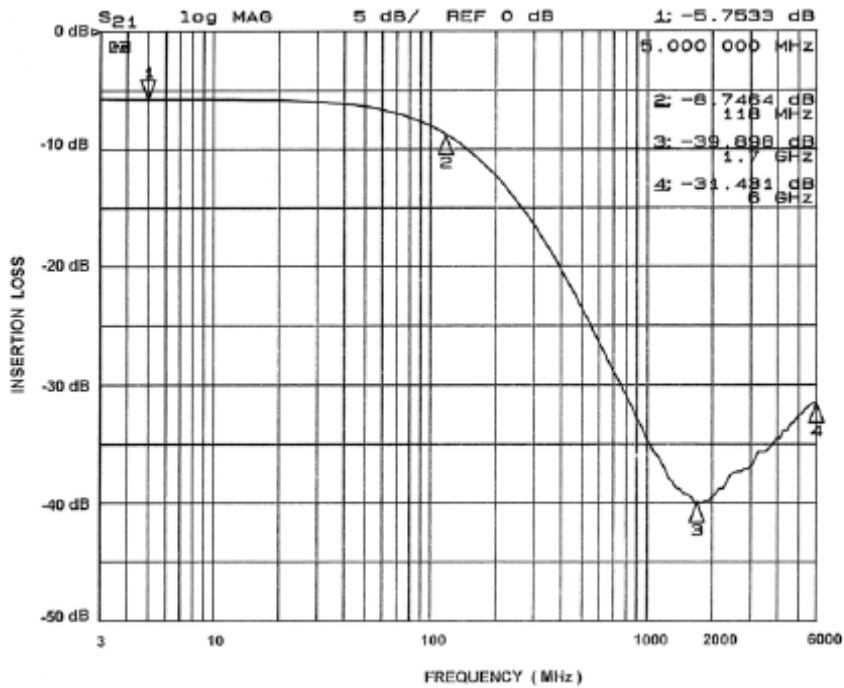

Figure 5. Insertion Loss vs. Frequency (A5-C5 to GND B3)

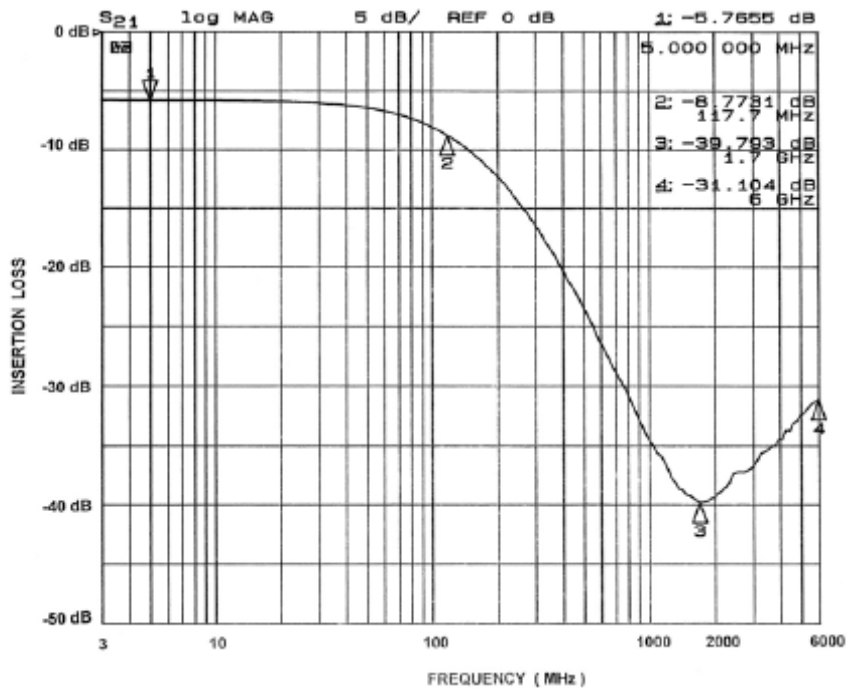

Figure 6. Insertion Loss vs. Frequency (A6-C6 to GND B3)

CM1442

PERFORMANCE INFORMATION (Cont'd)

Typical Filter Performance ($T_A = 25^\circ\text{C}$, DC Bias = 0 V, 50 Ω Environment)

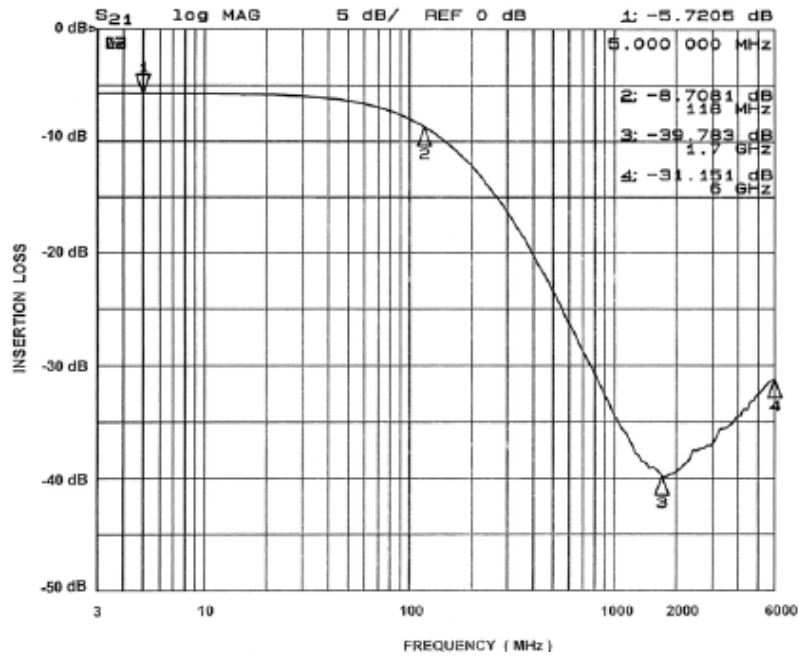

Figure 7. Insertion Loss vs. Frequency (A7-C7 to GND B4, CM1442-08CP Only)

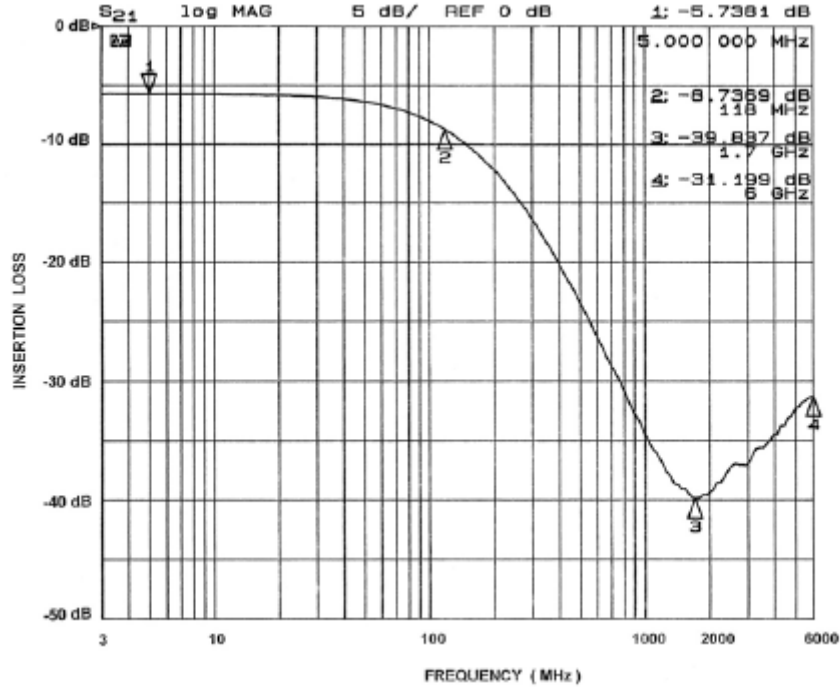

Figure 8. Insertion Loss vs. Frequency (A8-C8 to GND B4, CM1442-08CP Only)

PERFORMANCE INFORMATION (Cont'd)

Typical Diode Capacitance vs. Input Voltage

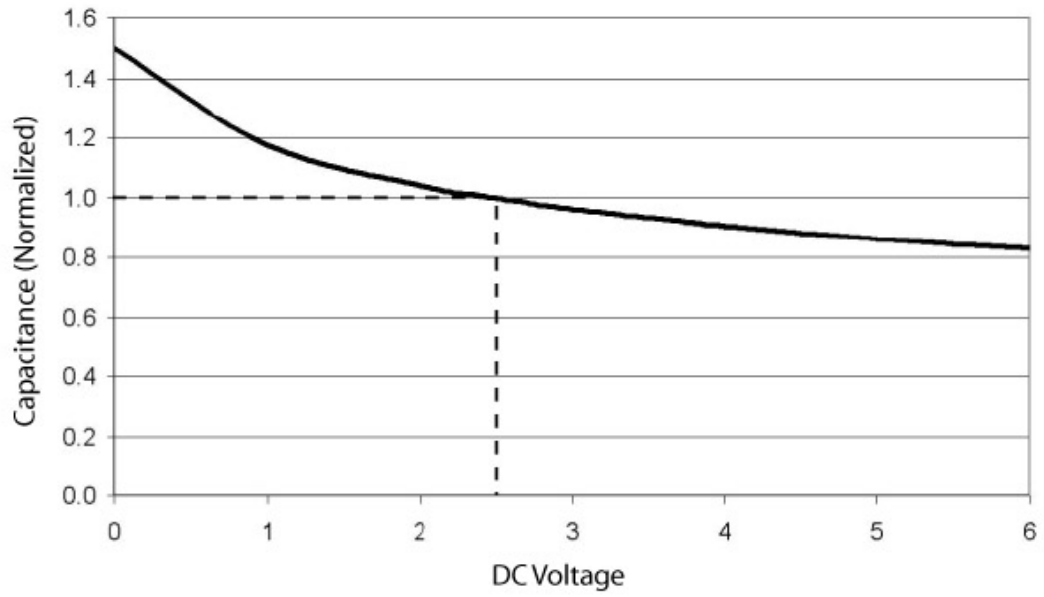

Figure 9. Filter Capacitance vs. Input Voltage
(normalized to capacitance at 2.5 VDC and 25°C)

APPLICATION INFORMATION

Table 5. PRINTED CIRCUIT BOARD RECOMMENDATIONS

Parameter	Value
Pad Size on PCB	0.240 mm
Pad Shape	Round
Pad Definition	Non-Solder Mask defined pads
Solder Mask Opening	0.290 mm Round
Solder Stencil Thickness	0.125 – 0.150 mm
Solder Stencil Aperture Opening (laser cut, 5% tapered walls)	0.300 mm Round
Solder Flux Ratio	50/50 by volume
Solder Paste Type	No Clean
Pad Protective Finish	OSP (Entek Cu Plus 106A)
Tolerance – Edge To Corner Ball	±50 µm
Solder Ball Side Coplanarity	±20 µm
Maximum Dwell Time Above Liquidous	60 seconds
Maximum Soldering Temperature for Lead-free Devices using a Lead-free Solder Paste	260°C

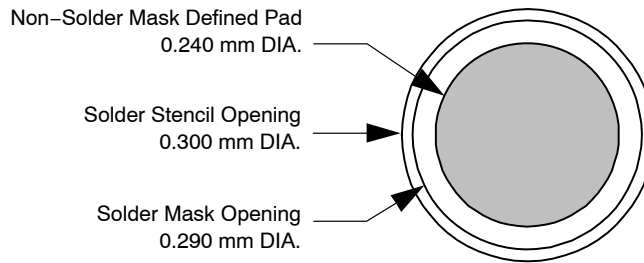

Figure 10. Recommended Non-Solder Mask Defined Pad Illustration

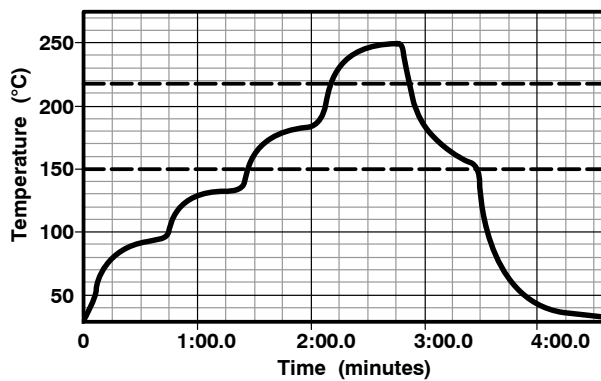
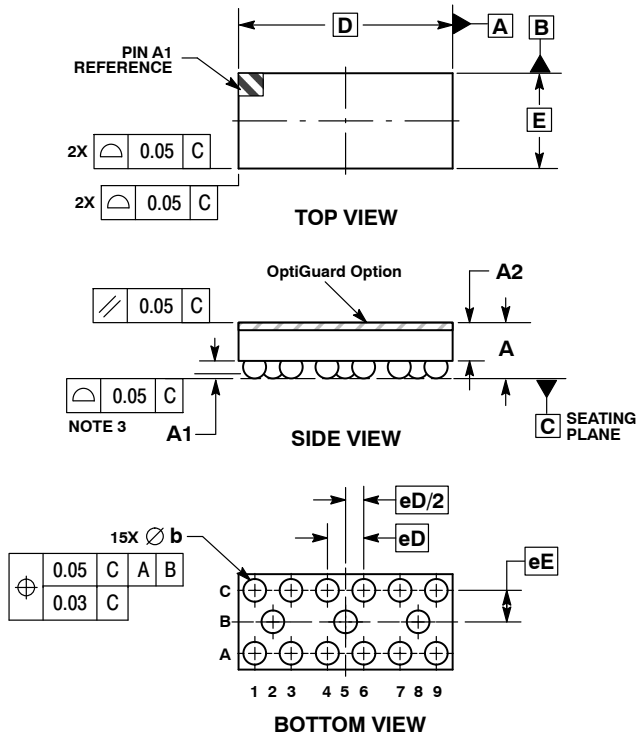

Figure 11. Lead-free (SnAgCu) Solder Ball Reflow Profile

CM1442

PACKAGE DIMENSIONS

WLCSP15, 2.36x1.05
CASE 567BP-01
ISSUE O



NOTES:

1. DIMENSIONING AND TOLERANCING PER ASME Y14.5M, 1994.
2. CONTROLLING DIMENSION: MILLIMETERS.
3. COPLANARITY APPLIES TO SPHERICAL CROWNS OF SOLDER BALLS.

DIM	MILLIMETERS	
	MIN	MAX
A	0.57	0.72
A1	0.17	0.24
A2	0.42 REF	
b	0.24	0.29
D	2.36 BSC	
E	1.05 BSC	
eD	0.400 BSC	
eE	0.347 BSC	

RECOMMENDED SOLDERING FOOTPRINT*

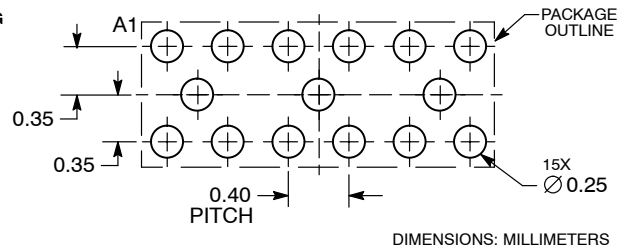

*For additional information on our Pb-Free strategy and soldering details, please download the ON Semiconductor Soldering and Mounting Techniques Reference Manual, SOLDERRM/D.

CM1442

PACKAGE DIMENSIONS

WLCSP20, 3.16x1.05
CASE 567BU-01
ISSUE O

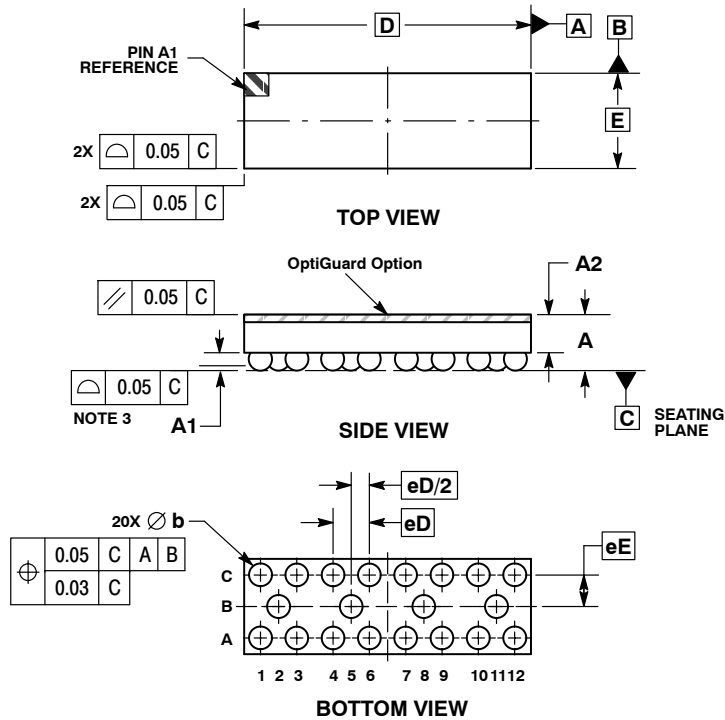

- NOTES:
1. DIMENSIONING AND TOLERANCING PER ASME Y14.5M, 1994.
 2. CONTROLLING DIMENSION: MILLIMETERS.
 3. COPLANARITY APPLIES TO SPHERICAL CROWNS OF SOLDER BALLS.

DIM	MILLIMETERS	
	MIN	MAX
A	0.54	0.69
A1	0.17	0.24
A2	0.42 REF	
b	0.24	0.29
D	3.16 BSC	
E	1.05 BSC	
eD	0.400 BSC	
eE	0.347 BSC	

RECOMMENDED SOLDERING FOOTPRINT*

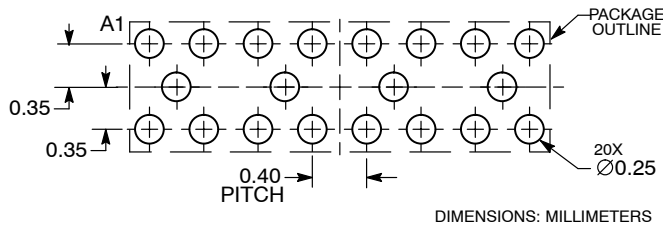

DIMENSIONS: MILLIMETERS

*For additional information on our Pb-Free strategy and soldering details, please download the ON Semiconductor Soldering and Mounting Techniques Reference Manual, SOLDERRM/D.

OptiGuard™ is a trademark of Semiconductor Components Industries, LLC.

ON Semiconductor and are registered trademarks of Semiconductor Components Industries, LLC (SCILLC). SCILLC reserves the right to make changes without further notice to any products herein. SCILLC makes no warranty, representation or guarantee regarding the suitability of its products for any particular purpose, nor does SCILLC assume any liability arising out of the application or use of any product or circuit, and specifically disclaims any and all liability, including without limitation special, consequential or incidental damages. "Typical" parameters which may be provided in SCILLC data sheets and/or specifications can and do vary in different applications and actual performance may vary over time. All operating parameters, including "Typicals" must be validated for each customer application by customer's technical experts. SCILLC does not convey any license under its patent rights nor the rights of others. SCILLC products are not designed, intended, or authorized for use as components in systems intended for surgical implant into the body, or other applications intended to support or sustain life, or for any other application in which the failure of the SCILLC product could create a situation where personal injury or death may occur. Should Buyer purchase or use SCILLC products for any such unintended or unauthorized application, Buyer shall indemnify and hold SCILLC and its officers, employees, subsidiaries, affiliates, and distributors harmless against all claims, costs, damages, and expenses, and reasonable attorney fees arising out of, directly or indirectly, any claim of personal injury or death associated with such unintended or unauthorized use, even if such claim alleges that SCILLC was negligent regarding the design or manufacture of the part. SCILLC is an Equal Opportunity/Affirmative Action Employer. This literature is subject to all applicable copyright laws and is not for resale in any manner.

PUBLICATION ORDERING INFORMATION

LITERATURE FULFILLMENT:
Literature Distribution Center for ON Semiconductor
P.O. Box 5163, Denver, Colorado 80217 USA
Phone: 303-675-2175 or 800-344-3860 Toll Free USA/Canada
Fax: 303-675-2176 or 800-344-3867 Toll Free USA/Canada
Email: orderlit@onsemi.com

N. American Technical Support: 800-282-9855 Toll Free
USA/Canada
Europe, Middle East and Africa Technical Support:
Phone: 421 33 790 2910
Japan Customer Focus Center
Phone: 81-3-5773-3850

ON Semiconductor Website: www.onsemi.com
Order Literature: <http://www.onsemi.com/orderlit>
For additional information, please contact your local Sales Representative

Looking for pricing, stock, or lifecycle information?

Click below to explore more details on WIN SOURCE:

- ⊖ [View CM1442-06CP](#) on WIN SOURCE
- ⊖ [ON Semiconductor](#) Information

Optimize Your Supply Chain with WIN SOURCE Solutions

- ✓ Global Sourcing Solution
- ✓ Obsolete Management
- ✓ Cost Control Management
- ✓ Shortage Management
- ✓ Alternative Solution
- ✓ Excess Inventory Management