



**THE DATASHEET OF  
251SHS3R3BSE**





**FEATURES**

- Lowest ESR in class, High Self-Resonant Frequencies, RF capacitors
- Highest working voltage in class: 1,500V
- Standard EIA sizes: 0402 - 1111
- Capacitance range: 0.1pF - 1,000pF
- NPO, RoHS & REACH compliant
- Operating temperature up to 125°C\*
- Laser Marked (optional)

**APPLICATIONS**

- Cellular Base Station Equipments
- Broadband Wireless Service
- Point to Point / Multipoint Radios
- RF Generators (NMR...)

**CIRCUIT APPLICATIONS**

- Filter Networks
- Matching Networks
- Tuning, Coupling and DC Blocking

**PHYSICAL CHARACTERISTICS**

- Chip capacitors for surface mounting with:
  - Copper barrier and tinning or Silver/Palladium (non magnetic)
  - Nickel barrier and tinning
- Ribbon leads for surface mounting

**ELECTRICAL AND ENVIRONMENTAL SPECIFICATIONS**

Electrical specifications	
Parameter	Value
Capacitance	0.2pF - 1,000pF
Tolerances	A, B, C, D below 10pF F, G, J, K above 10pF
Working voltage (WV <sub>DC</sub> )	See capacitance range chart
Temperature coefficient	0 ± 30ppm/°C, -55°C to +125°C For SHF and SHS: 0 ± 30ppm/°C, -55°C to +150°C
Insulation Resistance	10 <sup>5</sup> MΩ min.
Dielectric Withstanding (test voltage applied for 5 seconds)	2.5 x WV <sub>DC</sub> for WV <sub>DC</sub> ≤ 500V 1.8 x WV <sub>DC</sub> for extended range values ≥ 820pF 1.5 x WV <sub>DC</sub> for WV <sub>DC</sub> > 500V
Aging	none
Piezo Effect	none

Environmental specifications	
Parameter	Value
Life Test	2,000 hours, +125°C at 2 x WV <sub>DC</sub> (standard WV <sub>DC</sub> range) And SHB up to 100pF: 1,000 hours, 125°C at 500V
Moisture Resistance Test 1	240 hours, 85% relative humidity at 85°C (ESA/SCC n°3009)
Moisture Resistance Test 2	56 days, 93% relative humidity at 40°C 0V, 5V, WV <sub>DC</sub>

\* The temperature range for the SHB up to 100pF is upgraded from +125°C to +125°C.  
The temperature withstanding for SHF and SHS is 150°C for the whole capacitance range.

Capacitance	Breakdown voltage V <sub>peak</sub> (V)
15 pF	2700
39 pF	2000
100 pF	1400

Typical Breakdown Voltage SHB 45 MHz DC = 1%

**HOW TO ORDER**

501	SH	B	100	J	S	-	L	E	-RoHS
Voltage code	Dielectric	Size code	Capacitance code	Tolerance code	Termination code	Ribbon code	Marking code	Tape and reel	
<b>250</b> = 25V <b>500</b> = 50V <b>101</b> = 100V <b>201</b> = 200V <b>251</b> = 250V <b>301</b> = 300V <b>501</b> = 500V <b>601</b> = 600V <b>102</b> = 1,000V <b>152</b> = 1,500V  Please refer to voltage given in capacitance range chart	<b>SH</b> = NPO: (0 ± 30) ppm/°C	<b>L</b> = 0402 <b>S</b> = 0603 <b>A</b> = 0505 <b>F</b> = 0805 <b>N</b> = 1206 <b>T</b> = 1210 <b>B</b> = 1111	Please refer to Cap. Code given in capacitance range chart.	<b>A</b> = ± 0.05pF <b>B</b> = ± 0.1pF <b>C</b> = ± 0.25pF <b>D</b> = ± 0.5pF <b>F</b> = ± 1% <b>G</b> = ± 2% <b>J</b> = ± 5% <b>K</b> = ± 10%  See note 1	<b>S</b> = Standard: tin-plated nickel <u>Available on sizes 0505, 0603 and 1111.</u> <b>C</b> = Non-magnetic: tin-plated copper <u>Available on sizes 0505, 0805 [from 0.5pF to 150pF, consult us for higher cap. value], 1206 and 1210.</u> <b>A</b> = Non-magnetic: silver/palladium See note 2	--: no lead or ribbon  <u>Available on size 1111:</u> <b>1</b> = Micro-strip ribbons <b>6</b> = Radial Wires  See note 3	--: no marking  <u>Available on sizes 0505 and 1111:</u> <b>L</b> = laser marking	--: no tape and reel  <b>E</b> = Tape and reel packaging Number of components per reel: SHL: 10,000 SHA: 3,000 SHS: 4,000 SHF: 4,000 SHN: 3,000 SHT: 3,000 SHB: 1,000	The RoHS tag is not part of the reference  Tag added at the end of P/N for information

Note 1: For capacitance values less than 10pF, tolerances B, C and D available. Tolerance code A available for: L case for capacitance values of 0.2pF - 1.9pF. A case for capacitance values of 0.2pF - 4.7pF. S case for capacitance values of 0.2pF - 9.1pF. F case for capacitance values of 0.3pF - 2.2pF. N case for capacitance values of 0.5pF - 1.8pF. B case for capacitance values of 0.2pF - 3.3pF. For capacitance values of 10pF or higher, tolerances F, G, J and K available.

Note 2: All terminations are backward compatible and lead-free. The non-magnetic terminations are all Magnetism-free Rated.

Note 3: When coding ribbons for the description of the part, the termination has to be mentioned for MR certified types to ensure that only non-magnetic materials are used.

Note 4: Ribbon lead styles capacitors are not available in Tape and Reel.

Examples: 501 SHB 470 J1L any termination material could be used. 501 SHB 470 JC1L only non-magnetic termination materials could be used. Please consult us for specific requirements.

# SH Series

Super HiQ

**TYPICAL PERFORMANCE DATA**

S-Parameters available with ABC software.

**SHA (SIZE 0505): TYPICAL ESR VERSUS FREQUENCY**

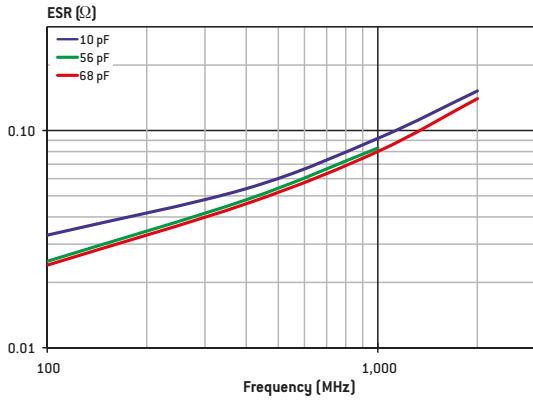

**SHB (SIZE 1111): TYPICAL ESR VERSUS FREQUENCY**

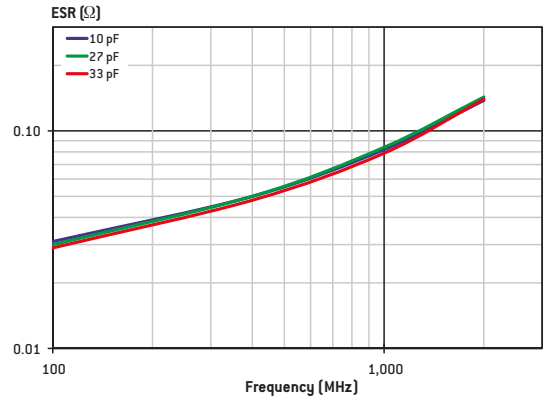

**SHS (SIZE 0603): TYPICAL ESR VERSUS FREQUENCY**

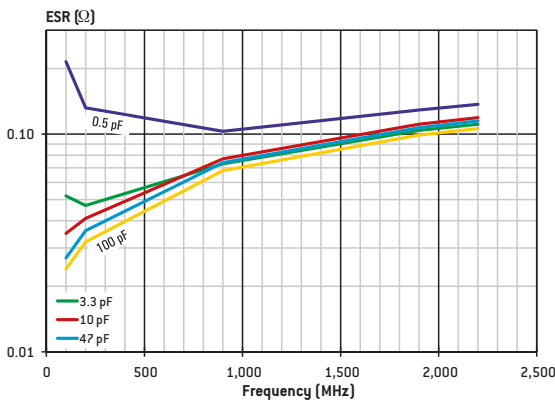

**SHS (SIZE 0603): TYPICAL Q FACTOR VERSUS FREQUENCY**

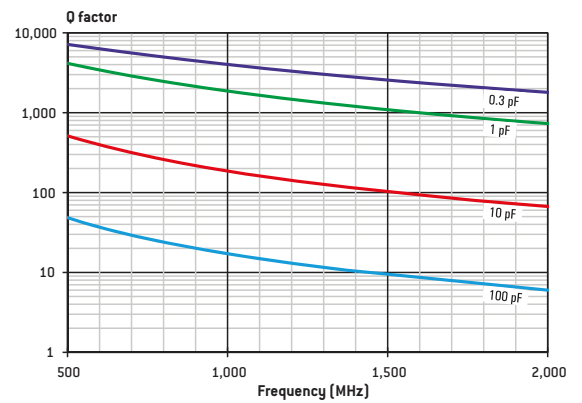

**SHF (SIZE 0805): TYPICAL ESR VERSUS FREQUENCY**

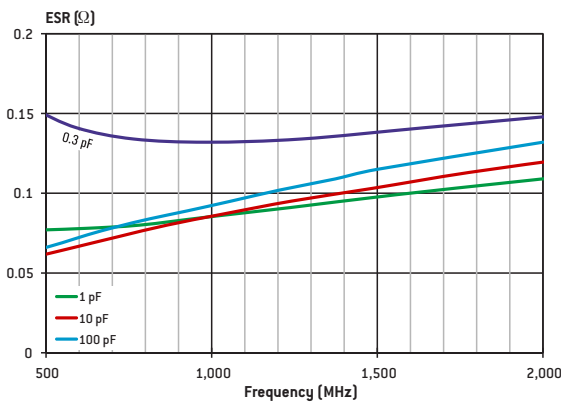

**SHF (SIZE 0805): TYPICAL Q FACTOR VERSUS FREQUENCY**

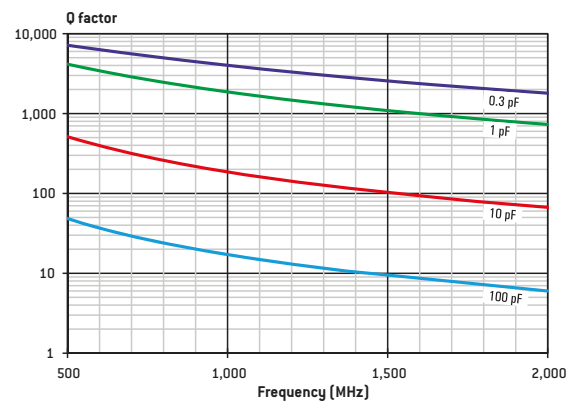

## DIMENSIONS in inches (mm)

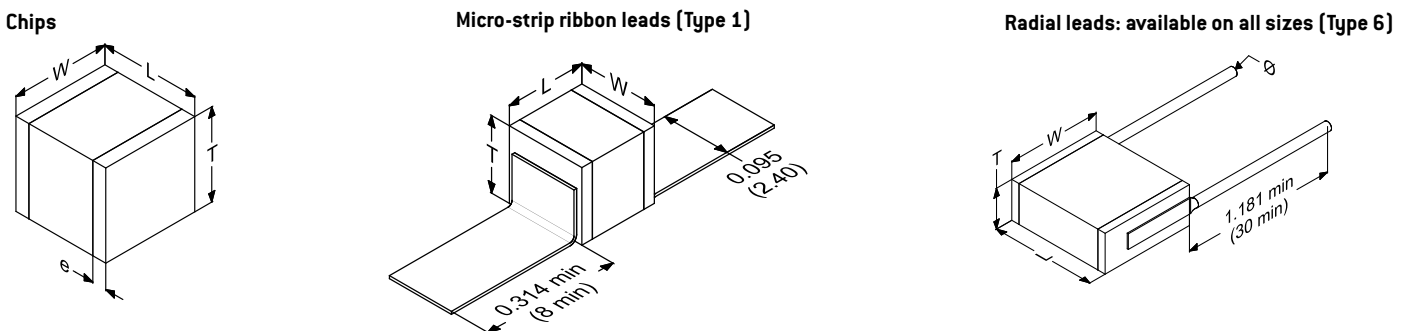

STANDARD RATINGS

Size		0402	0603	0505	0805	1206	1210	1111				
Size code		L	S	A	F	N	T	B				
Dimensions inches (mm)	L	0.039 ± 0.006 (1 ± 0.15)	0.063 ± 0.01 (1.6 ± 0.25)	0.055 ± 0.01 (1.4 ± 0.25)	0.08 ± 0.01 (2.03 ± 0.25)	0.125 ± 0.01 (3.18 ± 0.25)	0.125 ± 0.01 (3.18 ± 0.25)	0.110 ± 0.016 (2.80 ± 0.40)				
	W	0.02 ± 0.006 (0.5 ± 0.15)	0.032 ± 0.01 (0.8 ± 0.25)	0.055 ± 0.01 (1.4 ± 0.25)	0.05 ± 0.01 (1.27 ± 0.25)	0.062 ± 0.01 (1.58 ± 0.25)	0.095 ± 0.01 (2.41 ± 0.25)	0.110 ± 0.016 (2.80 ± 0.40)				
	T	0.02 max (0.51 max)	0.036 max (0.9 max)	0.056 max (1.4 max)	0.05 max (1.27 max)	0.05 max (1.27 max)	0.06 max (1.52 max)	0.103 max (2.60 max)				
	e	0.01 ± 0.006 (0.25 ± 0.15)	0.014 ± 0.008 (0.35 ± 0.2)	0.01 ± 0.006 (0.25 ± 0.15)	0.02 ± 0.012 (0.5 ± 0.3)	0.02 ± 0.01 (0.5 ± 0.25)	0.02 ± 0.01 (0.5 ± 0.25)	0.016 ± 0.010 (0.40 ± 0.25)				
Value (pF)	Cap. Code	Standard	Standard	Standard	Standard	Standard	Standard	Standard	Extended			
0.1	OR1	50 - 250V	250V	250V	250V	500V	500V	500V	1,500V			
0.2	OR2											
0.3	OR3											
0.4	OR4											
0.5	OR5											
0.6	OR6											
0.7	OR7											
0.8	OR8											
0.9	OR9											
1.0	1R0											
1.1	1R1											
1.2	1R2											
1.3	1R3											
1.4	1R4											
1.5	1R5											
1.6	1R6											
1.7	1R7											
1.8	1R8											
1.9	1R9											
2.0	2R0											
2.1	2R1											
2.2	2R2											
2.4	2R4											
2.7	2R7											
3.0	3R0											
3.3	3R3											
3.6	3R6											
3.9	3R9											
4.3	4R3											
4.7	4R7											
5.1	5R1											
5.6	5R6											
6.2	6R2											
6.8	6R8											
7.5	7R5											
8.2	8R2											
9.1	9R1											
10	100											
11	110											
12	120											
15	150											
16	160											
18	180											
20	200											
22	220											
24	240											
27	270											
30	300											
33	330											
36	360											
39	390											
43	430											
47	470											
51	510											
56	560											
62	620											
68	680											
75	750											
82	820											
91	910											
100	101											
110	111											
120	121											
130	131											
150	151											
160	161											
180	181											
200	201											
220	221											
240	241											
270	271											
300	301											
330	331											
360	361											
390	391											
430	431											
470	471											
510	511											
560	561											
620	621											
680	681											
750	751											
820	821											
910	911											
1,000	102											
		25 - 50V		200V		200V		100V	200V	300V	1,000V	
				150V R12N Series (See page 26)				100V		200V	600V	
				50V R12N Series (See page 26)					100V	50V	300V	

Special values, tolerances, higher WV<sub>DC</sub> and matching available, please consult factory.

# General Information

## CAPACITOR TERMINATIONS AND SOLDERING RECOMMENDATIONS

### I. TERMINATION TYPES

Our capacitors are delivered with one of the following terminations (for technical reasons, only a limited number of termination types are available in certain cases). All our terminations are backward compatible.

Parameter	Value	Comment
Termination Materials	A	non-magnetic (silver-palladium)
	C	non-magnetic (pure tin over copper barrier)
	S	lead-free (pure tin over nickel barrier)

NB:

- terminations type C recommended for non magnetic applications.
- termination type A available for non magnetic applications (for historical reason, we have also another code, the code "P", for the same type of termination. The parts that were designed-in before 2005 might still have a code "P" instead of "A" in the part numbering. But both codes correspond to the same type of termination).

### II. SPECIFICATIONS

Care must be taken when using particular terminations: if the terminations are heated up above a particular temperature and/or for too long a period of time, there is a risk of leaching (dissolution of the termination revealing the inner electrodes).

The chart below gives the resistance to soldering heat per termination type, based on a SAC387 solder bath at 260°C.

Dielectric Type	A	C	S
CHA / SHA		10 ± 1s [3]	120 ± 5s
CHB / SHB		30 ± 2s	120 ± 5s
CPX / CLX / CPE / CLE		30 ± 2s	120 ± 5s
CLF	10 ± 2s [1]	On request	120 ± 5s
SHL			120 ± 5s
SHS		10 ± 1s [4]	120 ± 5s
SHF / SHN / SHT	5 ± 1s [2]		120 ± 5s

- [1]: results extrapolated from 30 ± 2s data obtained with Sn62/Pb36/Ag2 solder bath.
- [2]: data obtained with Sn62/Pb36/Ag2 solder bath.
- [3]: termination only available on CHA series.
- [4]: preliminary data.

### III. STANDARD SMD REQUIREMENTS

#### III.1. Soldering Recommendations

Regarding the soldering attachments, three methods are generally used: the vapor phase soldering, the infrared reflow soldering and the wave soldering. Unless particular skill about the use of the wave soldering, this method is not recommended since the melted solder is directly in contact with the ceramic. This can potentially crack the capacitor because the ceramic is sensible to the thermal shocks. Moreover, this method needs to maintain the components with an insulating resin which increases the thermo-mechanical strains between the ceramic and the board both on soldering phase and operating

condition. The vapor phase and IR reflow soldering are less aggressive, inducing more restricted thermal shocks. This is the reason why they are preferred to the wave soldering method for reliable applications. In all cases, proper pre-heating is essential.

The circuit should be pre-heated at a typical rate of 1°C/s within 65°C to 100°C of the maximum soldering temperature. While multilayer ceramic capacitors can withstand the peak soldering temperatures for short durations, they should be minimized whenever possible.

Above precaution given for SMD types are applicable for the implementation of large bare chips (1515 and above). But in general, large bare chips above 2225 are not recommended to be mounted on epoxy printed board due to the thermal expansion mismatch between ceramic capacitor body and epoxy. This is the reason why leaded components will be preferred especially for reliable applications.

For information, the typical thermal profiles of these three soldering processes are given hereafter. These typical diagrams are only given as an aid to SMD users in determining specific processes linked to their instrumentations and to their own experience.

NB: reference documents are IEC 61760-1, CECC30000 and IEC68 standards. Please, refer to this standard for more information.

#### III.1.1. Vapour Phase Soldering

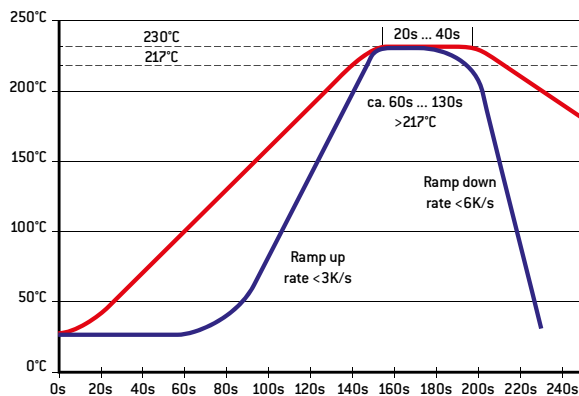

Lead free SnAgCu solders - Vapour Phase

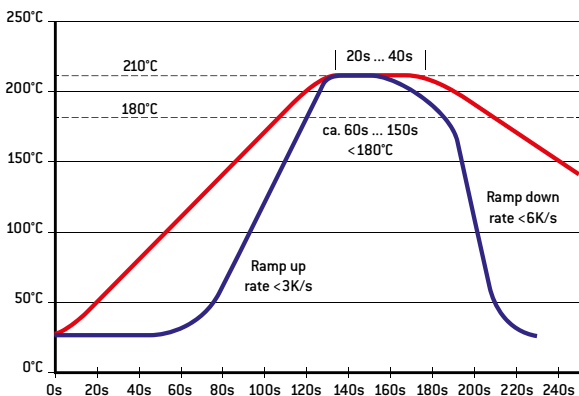

SnPb solders - Infrared Soldering

NB: the lines indicate the upper and lower limits of typical process (terminal temperature).

# General Information

## III.1.2. Infrared Soldering

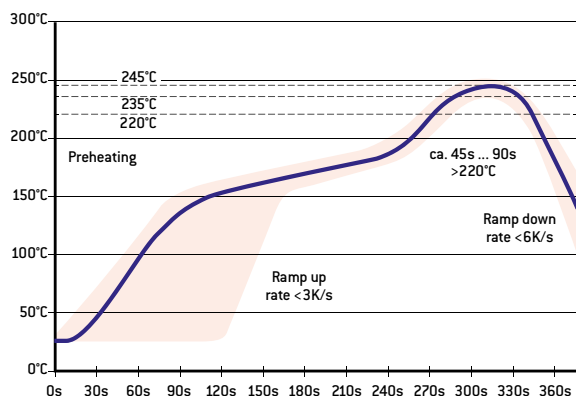

Lead free SnAgCu solders – Infrared Soldering

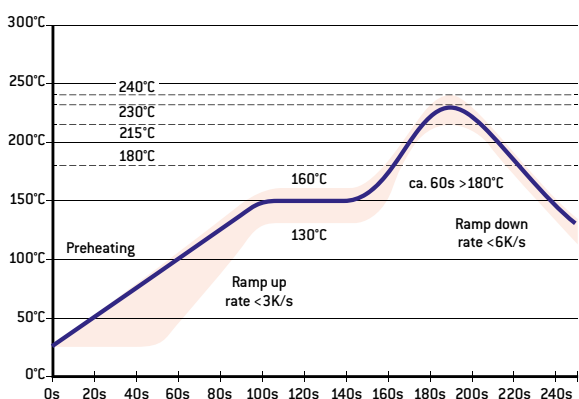

SnPb solders – Infrared Soldering

NB:

- these profiles are given for mid size components.
- continuous lines: typical process (terminal temperature).
- dotted lines: process limits, bottom process limit (terminal temperature), upper process limit (top surface temperature).

## III.1.3. Wave Soldering

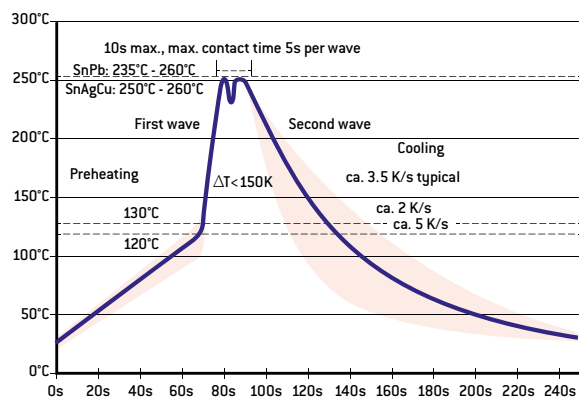

SnAgCu and SnPb solders - Double Wave Soldering

NB: • continuous lines: typical process.

- dotted lines: process limits.

## III.2. Moisture Sensitivity Classification

Our standard lead-free terminations - S and C types - have been fully tested and are compliant with the requirements mentioned in specification JEDEC STD 020 (level 1: not moisture sensitive).

## III.3. Whiskers Classification

Our standard lead-free terminations - S and C types - have been fully tested and are compliant with the requirements mentioned in specification JEDEC STD 201. Our terminations exhibit a matte finish and receive a special heat treatment to relieve stress inside the tin.

## III.4. Pad Dimensions

The metalized pads on the end user's substrate must be properly designed. Improper spacing or dimensioning of the pads may result in poor solder joints or a tombstone effect. Pad designs are given below for the most common sizes of multilayer ceramic capacitors for both wave and reflow soldering.

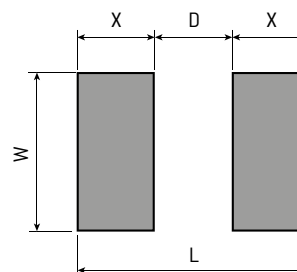

Case Size	W	X	D	L
SHL (0402)	0.70mm	0.90mm	0.40mm	2.20mm
CHA / SHA (0505)	1.80mm	1.00mm	0.80mm	2.80mm
SHS (0603)	1.00mm	1.10mm	0.60mm	2.80mm
SHF (0805)	1.50mm	1.30mm	0.60mm	3.20mm
CHB / SHB (1111)	3.00mm	1.00mm	1.90mm	3.90mm
CPX / CLX (2225)	6.90mm	1.00mm	5.00mm	7.00mm
CPE / CLE (4040)	10.20mm	1.10mm	8.30mm	10.50mm

NB: these dimensions are suggested for a reflow soldering process. If a wave soldering process is used, the X dimension has to be increased by 0.50mm (0.40mm for L and A case sizes), thus leading to an increase of 1.00mm to the L dimension (0.80mm for L and A case sizes).

# General Information

## SERIAL AND PARALLEL RESONANCE FREQUENCIES (SRF & PRF) OF CAPACITORS ON PCB

### I. INTRODUCTION AND DEFINITIONS

The equivalent model for a capacitor is usually defined by the figure 1 where:

- C** is the capacitance of the Capacitor
- RS** is the equivalent serial resistance [ESR]
- L** is the equivalent serial inductance [ESL]
- Cp** is the parasitic parallel capacitance
- Rp** is the Insulation Resistance

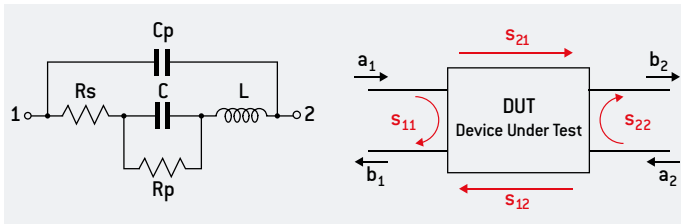

Figure 1: Equivalent Model

Figure 2: S parameters

The complex impedance Z is defined by:

$Z = ESR + jX$  and  $z = Z/Z_0$  [1] where z is the reduced impedance, X the reactance,  $Z_0$  the characteristic impedance (usually 50 ohm)

The impedance can be determined by the S parameters (figure 2) measurement for example with a serial configuration (Figure 3)

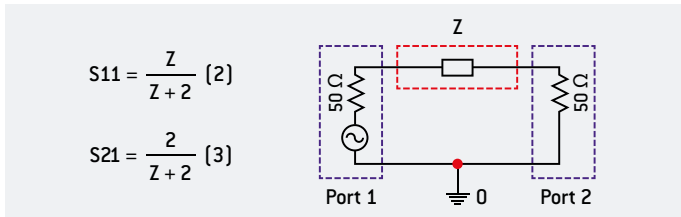

Figure 3: DUT Serial measurements

The variation of S11 (figure 4) and S21 (figure 5) show the different resonance frequencies SRF [serial resonance frequency] and PRF [parallel resonance frequency]

- The SRF is defined when the capacitor is a pure very small resistance:

$$SRF = \frac{1}{2\pi\sqrt{LC}} \quad (4a)$$

Therefore as X=0 the impedance defined in (1) is:

$$Z = ESR \quad (5)$$

At this frequency the ESR is usually low.

For example for a 251SHF150 (size 0805 and capacitance 15pf): SRF=2.64 GHz and the ESR at this frequency is 0.200 ohm (figure 5)

- The PRF is associated with the parasitic capacitance Cp defined in figure 1. Assuming that  $C_p \ll C$ , then:

$$PRF \approx \frac{1}{2\pi\sqrt{LC_p}} \quad (4b)$$

At this frequency the impedance is a pure very high resistance.

For example for a 251SHF150:

PRF=3.66 GHz and the ESR at this frequency is very high (figure 6)

The PRF could be determined by the S21 measurements (figure 5)

The lumped model shown in Fig. 1 explains only the existence of one serial self-resonant frequency and one parallel self-resonant frequency, consequently, the lumped model is unable to explain why real measurements exhibits a double infinity of self-resonant frequencies (see figures 4, 5 & 6).

It is currently admitted [Ref.1] that the lumped model shown in Fig. 1 is convenient only for frequencies that are lower than roughly the half of the first SRF. For frequencies close or above the first SRF, it is mandatory to consider the distributed model or transmission line model [Ref.1].

This distributed model can be established more easily with the equivalent circuit of a Single Layer Capacitor (SLC) shown in Fig. 7:

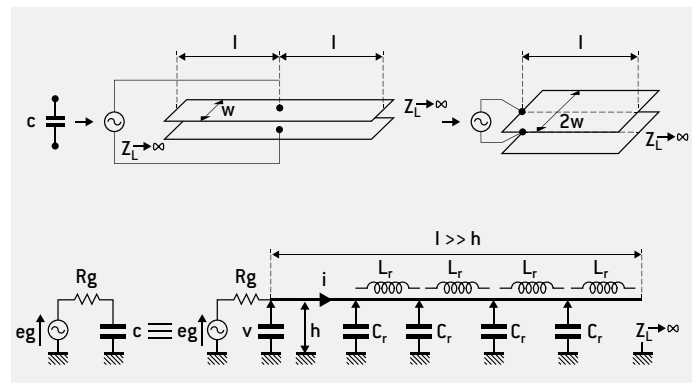

Figure 7: Transmission line model of a Single Layer Capacitor

After examination of Fig. 7, one can see that a Single Layer Capacitor can be modeled by a transmission line with an open termination that is currently called an "open stub".

According to classical courses relatives to transmission lines theory, it is well known that the variation with frequency of the input impedance of an open stub is given by:

$$Z_e = -jZ_c \cdot \cot g \left( \frac{2\pi l}{\lambda} \right) = -jZ_c \cdot \cot g \left( \frac{2\pi l}{c} f \right) \quad (5)$$

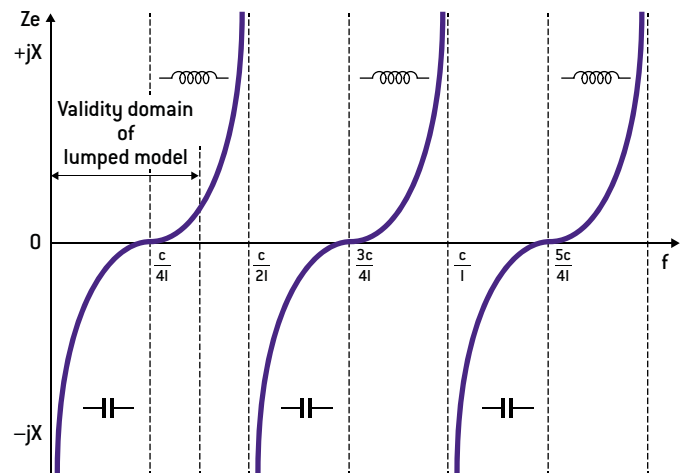

Figure 8: Plot of the theoretical expression (5) of the impedance of a Single Layer Capacitor modeled by an open stub

# General Information

The plot of the theoretical expression [5] of the impedance of a Single Layer Capacitor is shown in Fig. 8. As one can see, this theoretical curve predicts a double infinity of self-resonant frequencies (alternances of serial and parallel resonances) that are identical to the ones encountered in real world measurements.

Consequently, for predicting and understanding the behavior of a capacitor at frequencies that are close or above the first SRF, the lumped model (shown in Fig. 1) is not applicable and must be replaced by the distributed model or transmission line model (shown in Fig. 7).

Furthermore, according to [1], the transmission line model predicts accurately that the serial or parallel self-resonances are doubled when a capacitor chip is mounted with its internal electrodes oriented vertically (once again, it is impossible to predict such a phenomenon with the lumped model).

If now we take a closer look at a capacitor used as a coupling capacitor in a wide band application, it is evident when looking at fig. 8 that the coupling function will be correctly fulfilled at frequencies close to the serial resonant frequencies, since the capacitor's impedance is very low.

Conversely, the contrary will be encountered at the parallel resonant frequencies since the capacitor's impedance is very high and consequently the coupling function is not fulfilled.

Therefore in the application we must avoid to be at PRF. The High ESR may involve power loss and increase of internal temperature, since:

$$P = ESR I^2 \quad [6]$$

$$P = \frac{\Delta T}{R_{TH}} \quad (\text{stationary state}) \quad [7]$$

The temperature increase is therefore:

$$\Delta T = ESR I^2 R_{TH} \quad [8]$$

Where Rth is the thermal resistance of the capacitor with the PCB.

At first glance, equations [6], [7] & [8] confirm an increase of the internal temperature, but a closer look at these equations reveals that this temperature rise takes place only if the current I is constant. The problem is that in real applications the power source is rarely a pure current generator. More often than none, the power source is the dual of a current generator ie. a pure voltage generator. In the case of a circuit powered by a pure voltage generator, the contrary of the preceding behavior will be encountered at PRF since, as the capacitor's impedance is very high, the current I is very low and consequently, according to [6], [7] & [8] the temperature rise is not obvious or may be a temperature fall.

From these considerations, one can draw the conclusion that when a coupling capacitor is used at its PRF, for predicting an eventual temperature rise it is also mandatory to know for the PRF the behavior of the generator and the load between which the coupling capacitor is serially inserted.

In other words, the coupling capacitor is not the only cause of a temperature rise and consequently, the characteristics of the whole circuitry must be well known and understood prior to investigate the reasons of a temperature rise.

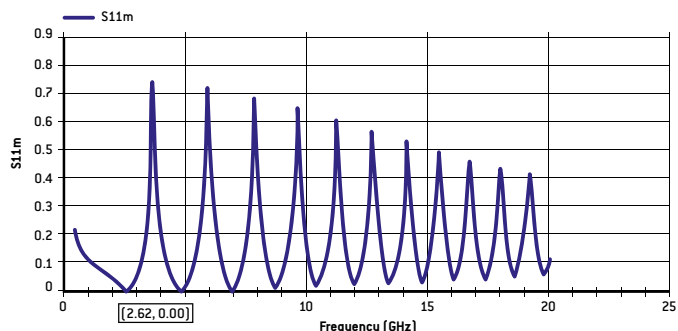

Figure 4: S11curve for a 251SHF150 from EXXELIA ABC software

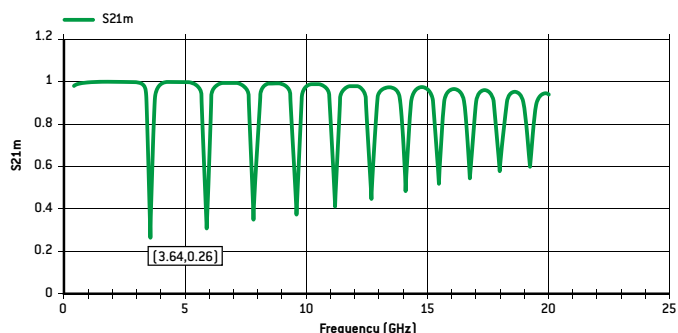

Figure 5: S21curve for a 251SHF150 from EXXELIA ABC software

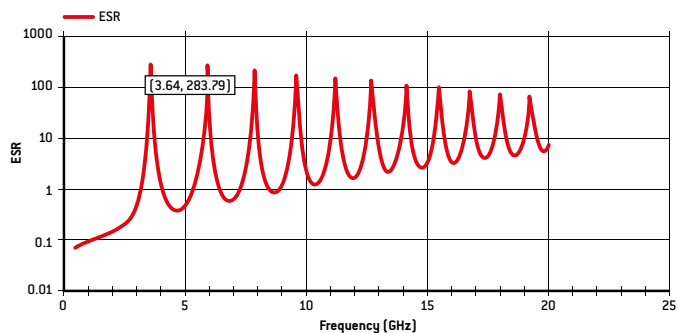

Figure 6: ESR curve for a 251SHF150 from EXXELIA ABC software

# General Information

## II. PARAMETERS OF SUBSTRATES AND CAPACITORS WHICH INFLUENCES THE PRF

As the PRF is linked to the parasitic parallel capacitance, when the capacitor is mounted on a PCB, the main parameters which could influence the PRF are:

- PCB parameters
- Capacitor parameters
  - Capacitance value
  - Geometry and size
  - Electrode orientation (horizontal or vertical)
  - Internal design

For example in the following screen plots, we can see that the first PRF is about 1.8GHz when the capacitor is mounted horizontally and is not visible when it is mounted vertically.

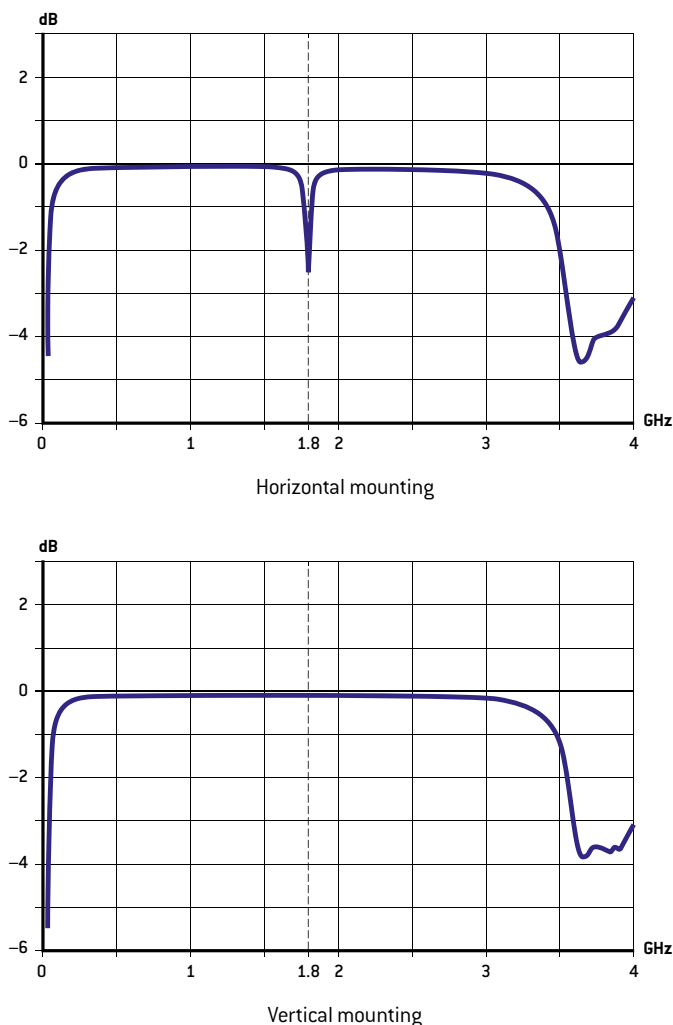

**Figure 9:** Example of PRF measurement (501SHB390JS on a FR4 PCB horizontal and vertical mounting)

[Ref. 1] Monolithic Capacitors as Transmission Lines. Marc INGALLS and Gordon KENT IEE Transactions on Microwaves Theory and Techniques, Vol. MTT-35, N°11 november1987, pp. 964-970.

## CAPACITOR RELIABILITY DATA MIL-STD CDR STYLES, RF & AMP; MICROWAVE SYSTEMS

### I. TYPICAL RELIABILITY TESTS

- Adhesive Strength of Termination
- Bending Strength
- Solderability of Termination
- Resistance to Soldering Heat
- Thermal shock -55°C to +125°C
- Humidity Load (240 hours, 85% relative humidity at +85°C)
- High Temperature Load (1000/2000h, 125°C, x U<sub>N</sub>)

### II. RELIABILITY DATA MONITORING

#### II.1. General Manufacturing Process

At each step of the manufacturing process, specific checks have been set-up to guarantee the quality level of our products. Statistical Process Controls (also known as SPC) are utilized to monitor key parameters within processes.

In addition to all these in-process controls, a sample of capacitors from each lot is micro-sectioned to check the internal structure and the absence of voids, delaminations, cracks or other defects.

When manufacturing is completed, the multilayer ceramic capacitors are fully screened for Capacitance, Dissipation Factor, Dielectric Withstanding Voltage, Insulation Resistance and Visual Defects.

#### II.2. Reliability Testing

During qualification of new capacitor series or at random intervals, EXXELIA performs life tests – 2,000 hours, +125°C, 2 x WV<sub>DC</sub> - and uses MIL-PRF-55681 as a guideline. The following parameters best describe our multilayer ceramic capacitors for military applications:

- data from MIL-PRF- 55681 revision F;
- capacitor, chip, multiple layer, fixed, ceramic dielectric, established reliability;
- rated temperature: -55°C to +125°C;
- CDR11, CDR12, CDR13 and CDR14 case sizes;
- Failure Rate levels C, M, P, R and S.

The data obtained from our continuous life test monitoring are used to calculate an equivalent part failure rate and to compare it to the Failure Rate level as defined in MIL-PRF-55681F. The methods and formulae used are based on MIL-HDBK271F and MIL-STD-690D.

An acceleration factor of 8:1 is used to relate life test data obtained at 200% rated voltage at maximum rated temperature, to rated voltage at maximum rated temperature (125°C). The following formula is used:

$$AF = \left( \frac{V}{V_0} \right)^3 \times 2^{\frac{T-T_0}{10}}$$

where V<sub>0</sub> is the rated voltage, T<sub>0</sub> the rated temperature, V and T the life test parameters.

### III. RELIABILITY DATA SUMMARY

As stated in MIL-STD- 690D, data are accumulated from sample units selected from a production run and produced with equipment and procedures normally used in production. One of the prerequisites for valid data is that all lots produced during the production period be represented. The data are from the same product in current production, i.e. data from products of preceding designs are not acceptable.

# General Information

### III.1. Failure Rate Level

The summary of all collected data gives the following results:

- cumulative unit hours in millions: 9.27;
- cumulative unit hours in millions with acceleration factor: 74.16;
- number of defects: 1.

We consider a single sampling plan based on a 90 percent confidence level: FRSP-90. For this FR sampling plan, MIL-STD- 690D gives the following criteria:

FR Level Symbol	Qualified FR Level (% per 1,000 hours)	Number of Failures Permitted
C	non-ER	N/A
M	1.0	1 over 0.389M hours
P	0.1	1 over 3.89M hours
R	0.01	1 over 38.9M hours
S	0.001	1 over 389M hours

EXXELIA Temex therefore complies with the requirements of C, M, P and R failure rate levels.

S failure rate level according to European Space Agency specifications 3009/035 and 3009/036.

### III.2. Mean Time To Failure

MTTF is the basic measure of reliability for non-repairable items. It is analogous to the more familiar MTBF (Mean Time Between Failures) used for systems which can be repaired and placed back in service after failure occurs. FR levels may be converted to mean time to failure (MTTF) as follows:

$$MTTF = \frac{100\,000}{FR\_level}, \text{ in failure per } 10^6 \text{ hours}$$

### III.3. Unit Hour Requirement

A complete Poisson distribution table is needed to compute unit hours. To calculate unit hours with a given number “C” of permitted failures (we are considering 1 permitted failure) we first have to determine the probability of acceptance P<sub>a</sub> by subtracting the FRSP value (0.90 as we have selected a confidence level of 90%) from 1.

Example: P<sub>a</sub> = 1 – 0.90 = 0.10

From Poisson’s table and for a Failure Rate level M, we find for the parameters “C” and P<sub>a</sub> equal respectively to 1 and 0.10 the corresponding “m” value of 3.89; this “m” value in the table is the total of failure rate λ multiplied by the time { test hours }.

$$M = \lambda \times t$$

unit hours = m ÷ λ { 1%/1,000hours as we are working with FR level M }  
 unit hours = 3.89 ÷ 0.00001 = 0.389 million hours (around 45 years)  
 Values for P, R and S levels are found by multiplying the previous level by 10.

## IV. PART FAILURE RATE

The Part Failure Rate as defined by MIL-HDBK- 217F is given by the following formula:

$$\lambda_p = \lambda_b \cdot \pi_{CV} \cdot \pi_Q \cdot \pi_E$$

where:

- λ<sub>b</sub> is the Base Failure Rate;
- π<sub>CV</sub> is the Capacitance Factor;
- π<sub>Q</sub> is Quality Factor;
- π<sub>E</sub> is the Environment Factor.

The Part Failure Rate, considering the capacitor series meet the required FR level, gives the number of failures per 10<sup>6</sup> hours. In MIL-HDBK-217F, the values for all these parameters are given under Capacitors, Fixed, Ceramic, Temperature Compensating and Chip paragraph. The CDR style as described by MIL-PRF-55681F is taken into account and corresponds to EXXELIA CHA and CHB sizes.

### IV.1. Quality Factor

The Quality Factor depends on the FR level. If we consider the three FR levels defined previously for EXXELIA multilayer capacitors, the given factors are:

Symbol	Product Level	π <sub>Q</sub>
C	non-ER	3.0
M	1.0 % per 1,000 hours	1.0
P	0.1 % per 1,000 hours	0.3

### IV.2. Environment Factor

All part reliability models include the effects of environmental stresses through the Environmental Factor. The descriptions of these environments are shown below and encompass the major areas of equipment use

Environment	Description	π <sub>E</sub>
G <sub>B</sub> : Ground, Benign	Non-mobile, temperature and humidity controlled environments readily accessed to maintenance; includes laboratory instruments and test equipment, medical electronic equipment, business and scientific computer complexes, and missiles and support equipment in ground silos.	1.0
G <sub>F</sub> : Ground, Fixed	Moderately controlled environments such as installation in permanent racks with adequate cooling air and possible installation in unheated buildings; includes permanent installation of air traffic control radar and communications facilities.	2.0
G <sub>M</sub> : Ground, Mobile	Equipment installed on wheeled or tracked vehicles and equipment manually transported; includes tactical missile ground support equipment, mobile communication equipment, tactical fire direction systems, handheld communications equipment, laser designations and range finders.	10.0

### IV.3. Part Failure Rate Calculation

The part failure rate calculated as specified in MIL-HDBK-217F provides a more accurate result than the standard failure rate given by a particular FR level. The two main parameters are the FR level achieved by the standard process – Quality Factor - and the application where the part will be used – Environment Factor. Specific study could be made on request based on customer’s requirements and equipments.

# General Information

## POWER CAPACITOR SOLUTIONS ULTRA-LOW ESR, HIGH RF POWER

In the RF world, one trend that continues to gain momentum is the need for higher RF output power in amplifier modules and systems. Associated to a growing demand for reduced unit size, the task for the designers and the component manufacturers is challenging.

First of all, the systems have to deal with higher RF power. At the component level, this means that a particular function which required only a single component previously has now to evolve to a sub-system made of several components to handle the total amount of power.

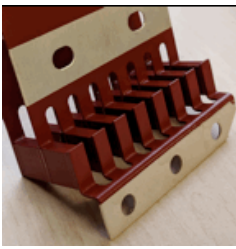

Example of capacitor Module

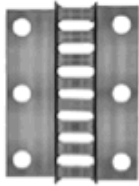

Example of X-Rays

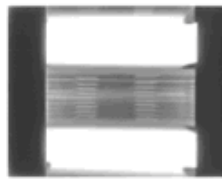

Capacitor size

Example of X-Rays analysis

Moreover, the reduction of the unit size led to higher operating temperatures, adding severe requirements on the components. They have to survive higher temperatures, being able to dissipate the generated heat – small packages produce much higher power densities – maintain their performances among huge operating temperature variations and offer mechanical flexibility to accept significant PCB thermal expansion.

Now, when coming to the capacitor world, these new needs will affect the “single-chip” standard model. For instance, when one capacitor was enough to ensure the matching of a 100 W RF transistor, the recent 1'000W transistors need “n” capacitors, even sometimes with an increased size.

In order to get a better understanding of these new requirements and to study the “n-chip” model, we will first look at the key parameters of high RF power systems. Then, depending on the key parameter(s) considered, we will see which Power Capacitor Solution is best-tailored to the designer needs.

### I. HIGH RF POWER

#### I.1. Voltage Rating

Maximum voltage ratings for ceramic capacitors ( $WV_{DC}$ ) are linked to two factors: strength of the dielectric and Paschen's law. The strength of the dielectric provides a maximum voltage breakdown and the Paschen's law provides another maximum voltage above which the air around the chip arcs.

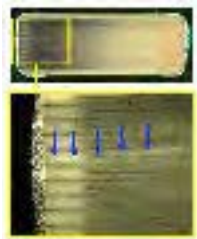

Strength of Dielectric



Paschen's Law

The voltage rating of the ceramic capacitor is then defined as the lowest value when considering both limitations.

#### I.1.1. Dielectric Strength

The capacitor maximum voltage rating is determined predominantly by the dielectric strength or voltage breakdown characteristics. For instance, porcelain dielectrics exhibit a breakdown voltage that typically exceeds 1'000 kV<sub>DC</sub>/inch of dielectric thickness.

Material	Dielectric Strength (kV/inch)
Vacuum	20
Air	20 to 75
Porcelain	40 to 200
Glass	2'000 to 3'000
Mica	5'000

For multilayer capacitors for instance, this means that one particular layer of standard dielectric – let's consider a theoretical 5 mils thick layer – will not crack until the voltage exceeds a value around 5'000 V<sub>DC</sub>. In order to achieve even higher voltage ratings, specific internal electrode designs are used to split the voltage.

#### I.1.2. Paschen's Law

In 1889, F. Paschen published a paper (Wied. Ann., 37, 69) which set out what has become known as Paschen's Law. The law essentially states that the breakdown characteristics of a gap are a function (generally not linear) of the product of the gas pressure and the gap length, usually written as  $V = f(pd)$ , where p is the pressure (in Torr) and d is the gap distance (in cm):

$$V = \frac{365 \times p \times d}{1.18 + \ln(p \times d)} \quad (1)$$

Note: 1 bar = 100'000 Pa = 750 Torr = 14.5 psi.

For instance, if we consider an E-type capacitor (CLE series with an EIA chip size of 4040), the length between the two terminations (“L” as shown below) is around 10.50 mm.



This means, using the Paschen's law ( $p=750$  Torr;  $d=1.05$  cm), that if the voltage across such equivalent air gap exceeds 36'600Vdc, an electric arc would be created. However, when dealing with the gap between the two capacitor terminations, another parameter has to be considered. Actually, as the dielectric material is charged, there is an ionization of air which influences the Paschen's law. Therefore, for the capacitor considered in this example, a voltage around 10'000 V<sub>DC</sub> will probably create a short circuit on the capacitor external surface (carbon residues from the arcing). Moreover, the electric arc itself could damage nearby components.

For applications where very high voltages are needed, a specific coating would be applied on the capacitor, thus covering both terminations. In this case, the gap itself disappears and no electric arc could occur.

#### I.2. Current Rating

The current rating assigned to a capacitor is stated in one of two ways: voltage limited or power dissipation limited. The rating that applies depends on the capacitance value and operating frequency. The voltage limited area is based on the voltage rating. The power dissipation limited area is based on the ability of the capacitor to dissipate the heat. The current rating of the ceramic capacitor is then the lowest value.

#### I.2.1. Voltage Limit

The maximum current for the voltage limited operating condition is directly proportional to the capacitor voltage rating and the impedance:

$$I_{Vm} = WV_{DC} \times \sqrt{2} / Z \quad (2)$$

$$Z = \sqrt{ESR^2 + (L\omega - 1/C\omega)^2} \quad (3)$$

# General Information

When the frequency is enough low and ESR negligible:

$$Z \approx \{1/C\omega\} \quad (4)$$

$$\text{Then } I_{Vm} \approx 2\pi \times W_{DC} \times \sqrt{2} \times f \times C \quad (5)$$

### 1.2.2. Power Dissipation Limit

The maximum RMS current for the power dissipation limited operating condition is directly proportional to the maximum power dissipation of the device and the Equivalent Series Resistance:

$$I_{p(RMS)} = \sqrt{\frac{Pd_{max}}{ESR}} \quad (6)$$

$Pd_{max}$  is the maximum power dissipation of the device as defined in reference to a given mounting surface with known characteristics. The thermal resistance ( $\Theta_c$ ) of a ceramic capacitor operating in a given application is a key factor to establish the device power rating:

$$Pd_{max} = \frac{T_{max} - T_{amb.}}{\Theta_c} \quad (7)$$

### 1.2.3. Maximum current

The maximum current is :

$$I_{max} = \text{minimum} (\sqrt{I_p(RMS)}, I_{Vm})$$

Considering the general trend of the current with the frequency:

- (5) shows that  $I_{Vm}$  increases with the frequency
- (6) shows that  $I_p(RMS)$  decreases with the frequency (ESR increases with frequencies in a general trend with skin effect)

Therefore typically the maximum current is limited

- By  $I_{Vm}$  at low frequencies
- By  $I_p(RMS)$  at higher frequencies

## 1.3. HEAT TRANSFER

### 1.3.1. Thermal Convection

Convection is a heat transfer produced by the motion of a mass of fluid such as air or water when the heated fluid is caused to move away from the source of heat, carrying energy with it. Convection above a hot surface occurs because at constant pressure, hot air expands, becomes less dense, and rises.

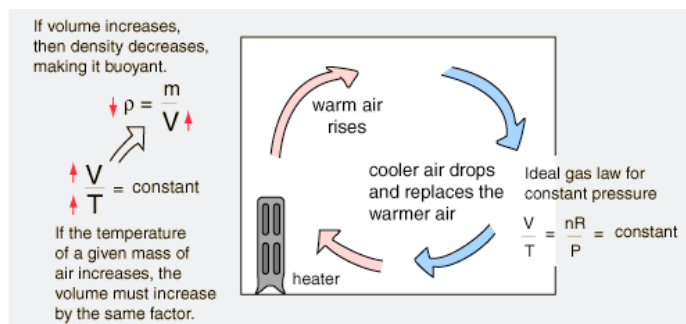

### 1.3.2. Thermal Radiation

Radiation is a heat transfer produced by the emission of electromagnetic waves which carry energy away from the emitting object. For ordinary temperatures, the radiation is in the infrared region of the electromagnetic spectrum. The relationship governing radiation from hot objects is called the Stefan-Boltzmann law:

$$P = \epsilon \times \sigma \times A \times (T^4 - T_c^4) \quad (8)$$

Where:

- P** is the net radiated power
- ε** is the emissivity coefficient (1 for ideal radiator)
- σ** is the Stefan's constant (5.6703.10-8 W/m².K4)
- A** is the radiating area
- T** is the temperature of radiator
- Tc** is the ambient temperature

### 1.3.3. Thermal Conduction

Conduction is a heat transfer by means of molecular agitation within a material without any motion of the material as a whole. If one end of a metal rod is at a higher temperature, then energy will be transferred down the rod toward the colder end because the higher speed particles will collide with the slower ones with a net transfer of energy to the slower ones.

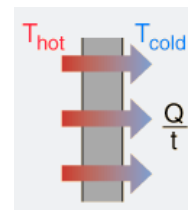

For a heat transfer between two flat surfaces, such as heat loss through the wall of a house, the rate of conduction heat transfer is:

$$\frac{Q}{t} = \frac{K \times A \times (T_{hot} - T_{cold})}{d} \quad (9)$$

Where:

- Q** is the heat transferred with the time  $t$
- K** is the thermal conductivity of the barrier
- A** is the conducting area
- T** is the temperature
- d** is the thickness of the barrier

Conceptually, the thermal conductivity can be thought as the rate of heat loss per unit area to the rate of change of temperature.

$$\frac{dQ}{dtA} = -\kappa \nabla T \quad (10)$$

The net heat transfer is in the opposite direction of the temperature gradient

For a stationary state and without internal heat source: [1]

$\nabla^2 T = 0$  therefore for one dimensional equation  $T = Ax + B$  (A and B are constants)

Considering the following capacitor where

$T_{max}$  is the maximum temperature of capacitor (°C) located at the center of the capacitor

$T_{amb.}$  is the application ambient temperature in operating conditions (°C) located at both terminations if the thermal transfer of the connections is enough efficient.

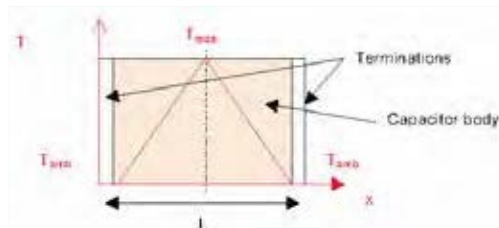

Temperature profile inside the capacitor

The thermal resistance  $\Theta_c$  of the capacitor is composed on two parallel thermal resistance  $\Theta$ :

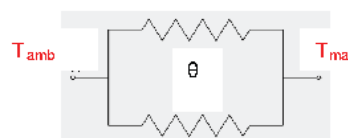

# General Information

The thermal resistance  $\Theta_c$  of the capacitor is:

$$\frac{1}{\Theta_c} = \frac{2}{\Theta} \quad (11)$$

and

$$\Theta = \frac{L/2}{A \times \lambda} \quad (12)$$

therefore

$$\Theta_c = \frac{L}{4 \times A \times \lambda} \quad (13)$$

Where

- $\lambda$  is the coefficient of thermal conductivity of the ceramic body  $W.cm^{-1}.C^{-1}$
- $A$  is the section surface (thickness x width)  $[cm^2]$
- $L$  is the length of the capacitor  $[cm]$

The geometry of the capacitor (A/S) influences the thermal resistance. For example 0711 size [Exxelia reference=SHD] has a factor A/S more beneficial than 1111 size to reduce thermal resistance of the capacitor.

Considering the non-stationary state, we must solve equation (10). For example if we consider a capacitor an initial temperature  $T_{amb}$  and a final temperature  $T_{max}$ , we may use the following equation for the temperature evolution: [2]

$$T(t) = T_{max} - (T_{max} - T_{amb}) \exp\left(-\frac{t}{mC_p\Theta_c}\right) \quad (14)$$

Where :

- $m$  is the mass of the capacitor
- $C_p$  is the thermal capacity
- $\Theta_c$  is the capacitor thermal resistance

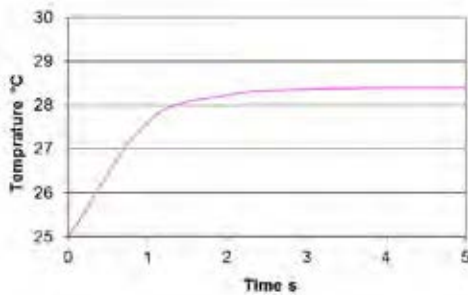

Example of the temperature evolution inside the capacitor where  $T_{amb} = 25^\circ C$  and  $T_{max} = 28.3^\circ C$

## I.4. Global Power Model

All the above parameters have to be kept in mind when designing a high RF power function. The capacitors used in the application should be fine-tuned to make sure their voltage rating, their current rating and their heat transfer capabilities are in line with the required specifications. Moreover, the specifications do not only include the capacitor by itself, but also the PCB properties and the environment where the complete system operates.

Let's consider for instance the Global Power Model of a single capacitor mounted on a PCB studied at a working frequency of 50 MHz.

The component characteristics are as-follows:

- Type: EXXELIA CLE series
- Voltage rating: 7'000  $V_{DC}$
- Capacitance value: 22 pF

First, the size of the component will give the capacitor thermal resistance – its ability to dissipate heat. Then, in the PCB specification, we will look for its thermal resistance properties. The environment – how the system is working in normal/maximum operation – will tell us the theoretical ambient temperature. Finally, the capacitor electrical parameters will be used – capacitance value, voltage rating and ESR.

All these data are compiled in a simulation program which calculates the maximum current rating of the capacitor for the considered system, at one particular frequency:

Designation of the part:	702 CLE 220 GSLE
Select the capacitor type:	CLE
Capacitor Length:	10,50 mm
Capacitor Width:	9,50 mm
Capacitor Height:	4,50 mm
Capacitor thermal resistance:	10,23 °C/W
PCB thermal resistance:	7,37 °C/W
Capacitor max operating temperature:	125 °C
Ambient temperature:	25 °C
Capacitance value:	22 pF
Rated DC voltage:	7 000 V
Frequency:	50,00 MHz
Duty Cycle:	5 %
ESR @ Frequency:	0,042 Ohm
The limitation is over by the:	Voltage
The maximum current is:	34,210 Arms
The maximum voltage is:	4 950 Vrms

As previously written, the current rating assigned to a capacitor is stated in one of two ways: voltage limited or power dissipation limited. The software calculates both limitations:  $I_v$  for the voltage and  $I_p$  for the power. Finally, the smallest value is taken as it represents the first limitation the user will reach when using the system.

In the example above at 50MHz, the capacitor, according to its power dissipation limitation, should handle around 52A ( $I_p$ ) but the voltage limitation will actually not allow it to handle more than 34A ( $I_v$ ). If the capacitance function has to handle more current, then the designer has to switch to the "n-chip" model and to use a combination of several capacitors, a.k.a as Power Capacitor Solutions.

## II. POWER CAPACITOR SOLUTIONS

More RF power means either a higher current or a higher voltage, sometimes both. As the current and voltage laws are quite fixed for capacitors – physical limitations give few options on dielectric thickness and number of electrodes which are key to handle more power in a single component – the only way to handle more power, for a given ultra-low ESR series, is to increase the number of capacitors.

This led to a new branch of capacitor knowledge dedicated to thermal and power analysis, mechanical assembly, high temperature PCB soldering and specific RF test procedures.

The Power Capacitor Solutions are especially dedicated to applications where high reliability, high operating voltages, high operating currents, ultra-low ESR and tighter tolerances are required. Most of these applications are found in the following markets:

- Medical Electronics;
- Broadcasting Equipment;
- Semiconductor Manufacturing;
- Inductive Heating;
- LASER Power Supplies;
- MRI High Magnetic Environments;
- Military Systems.

### II.1. Parallel Combinations

To deal with a higher operating current or to further reduce our ultra-low ESR, one can use combinations of HiQ ceramic capacitors in parallel – current rating multiplied.



# General Information

## II.2. Series Combinations

To deal with a higher operating voltage, one can use combinations of HiQ ceramic capacitors in series, within the same dielectric die or using separate entities – voltage rating multiplied.



## II.3. Matched Sets

To achieve non-standard total capacitance values or ultra-tight tolerances, EXXELIA can match capacitors using computer specific software. Another use of matched sets is to reduce the overall purchasing costs; when several capacitors are used in parallel, a given tight tolerance can still be obtained on the final assembly while using wider tolerance single chips.

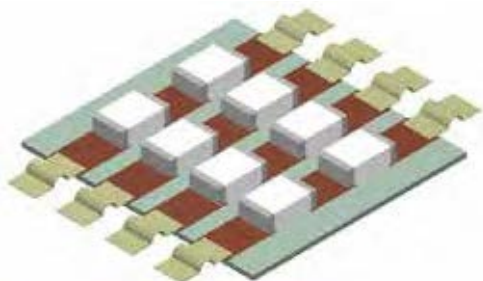

## III. GUIDELINES

Several factors have to be considered when designing high RF power applications and these factors are in fact all linked to the overall thermal management of the entire design.

### III.1. Influence of ESR

The capacitors with ultra-low ESR provide a higher maximum current for power dissipation limited operating conditions – as  $I_p = f(\frac{1}{ESR})$  – allowing the overall design to handle more RF power. Of course, the dissipation factor characteristics also have to be compliant with this increased power.

In the example below, a 300W CW module at 350MHz is pushed above its limits to emphasize the importance of ESR.

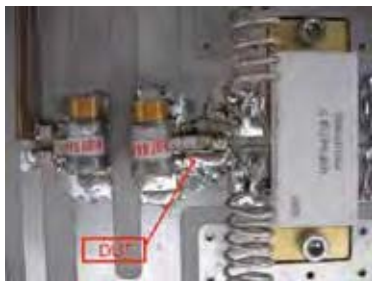

In the same conditions, several capacitor types are monitored as DUT and the results are shown below:



## III.2. Influence of Magnetism

The choice of Power Capacitor Solutions in high magnetic field environment is critical. EXXELIA has conducted several tests with both his final customers and external laboratories to extend his knowledge and develop better solutions. These solutions play a major role in reducing the overall system temperature. Please contact EXXELIA for any further information.

## III.3. Generic Comments

The main guidelines to lower the overall thermal load on the design are listed hereafter:

The thermal conductivity of all devices involved as well as board trace dimensions and material thickness have to be evaluated;

The main part of the heat transfer is achieved by thermal conduction. Actually, around 80% of the power is dissipated by conduction, 15% by convection and 5% by radiation. Therefore, the greater part of heat transfer is through the terminations of the capacitors. In order to further improve the thermal path of a porcelain capacitor, one should use leads such as non-magnetic micro-strip silver ribbons. The leads also offer another advantage: when the thermal expansion coefficients of the capacitor and the board are mismatched, they may act as a mechanical strain relief;

To avoid reducing drastically the thermal conductivity at some specific locations within the circuit, one should avoid reducing the width of the board trace and using wires;

Heat sinks and blown cool air will also help to reduce the additional sources of heat generated by passive components, FETs and active gain blocks;

Paschen's law defines the voltage rating for a given pressure. Therefore, depending on the operating conditions, the pressure parameter has to be considered (coating, voltage safety margin...);

Using Power Capacitor Solutions with parallel combinations will extend the RF power handling. For instance, N capacitors in parallel will led approximately to an ESR which is N-times lower than the one of a single capacitor, thus increasing the maximum current handling capability by a factor of  $\sqrt{N}$ .

## IV. CONCLUSION

This article has described the major factors to consider while designing a Power Capacitor Solution for high RF power applications. The benefits of using Power Capacitor Solutions are numerous: high RF power, enhanced reliability with pre-tests, ultra-low ESR, reduced costs with matched sets, availability of specific capacitance values and tolerances, fewer assembly stages, customized styles...

To ensure the highest level of reliability in high RF power designs, factors such as heat transfer, maximum voltage and current ratings, thermal characteristics of the circuit devices and ways to remove the heat should be taken into account.

EXXELIA designs Application-Specific Solutions based on parallel and series combinations of designer-acclaimed capacitors. Customer requirements are addressed by computer matching sets, a wide range of mechanical configurations, a protective coating and adapted ribbons or wires which have enabled EXXELIA to extend overall performance while decreasing the total cost of ownership.

EXXELIA - by knowing the ESR and power dissipation of its capacitors at the application operating frequencies - helps the designers by simulating the thermal behavior of the assembly and proposing the optimum Power Capacitor Solution.

Ref

- [1] Thermal Conductivity wikipédia
- [2] Cours de thermique P.ROUX (2016)

# General Information

## POWER CAPACITOR ENDURANCE TESTING ULTRA-LOW ESR, HIGH RF POWER

### I. FOREWORDS

#### I.1. Concept

Figure 1 shows the general concept. The setup contains a direct digital synthesizer (DDS) that generates an RF signal with a variable frequency. Its signal is amplified by a driver stage followed by a power amplifier stage. The gain of the PA stage is controlled by varying its supply voltage. For that purpose a variable power supply is provided. The directional coupler measures the forward and the reflected power. The latter is a value that describes the quality of the matching condition. The role of the matching network is to match the capacitor to a 50W load. The capacitor under test is mounted on a separate printed circuit board and is encapsulated by a small cabinet. This cabinet isolates the capacitor from the ambient temperature. A temperature sensor is integrated into the cabinet to measure the capacitors temperature.

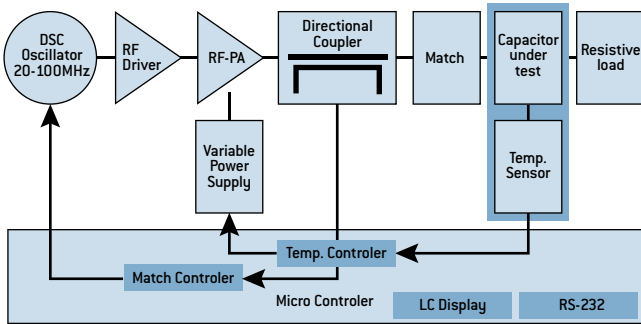

Figure 1

With a microcontroller, there are two control loops realized. The temperature of the capacitor is measured at the beginning of the 5 seconds off time with a temperature sensor. The sensor's signal is used to control the variable power supply which influences the power amplifiers gain and as a consequence, the output power or the current through the capacitor under test.

The ground plane improves the heat spread between the capacitors. This is further supported by a copper bar that is directly pressed on the ground plane of the PC board. On the front side of the copper bar, a NTC is mounted. Tests have shown that this heat coupling is very critical for the overall performance. The NTC is screwed directly and by that the heat coupling is both tight and reliable.

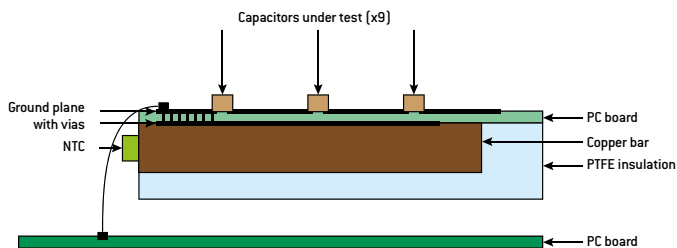

Figure 2

#### I.2. Test Cycle

The complete test cycle is shown in figure 3. The test starts with a tuning procedure at low power. As soon as the matching condition is achieved the RF power is set to the value that is necessary to heat the capacitors. During the ON time, the frequency is continuously adjusted to minimize the reflected power. After 5 seconds ON, the RF is switched off for the next 5 seconds. Then the RF is switched on again. Because the capacitors have cooled down during the OFF time, the test generator needs to re-tune.

The re-tune procedure takes 500ms. After that, the RF is ON for the next 5 seconds. That way a complete cycle takes 10 seconds.

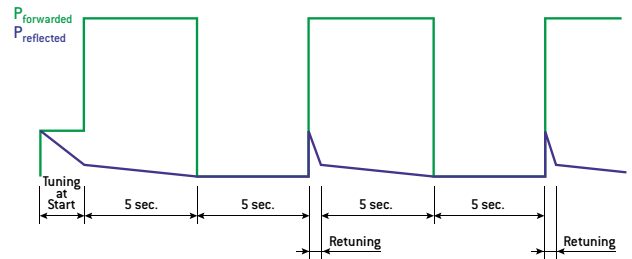

Figure 3

The following conditions have been used:

- HiQ multilayer ceramic capacitors operated at 27MHz;
- 2 complete test sets are done, one for B size (1111) and another for X size (2225);
- a complete test set represents 1 million cycles (4 months of continuous RF power).

#### I.3. Data Acquisition

The test generator measures continuously: the frequency, the forward power, the reflected power and the three temperatures. The test generator stores these values always at the end of the 5 seconds ON time. The remote computer gathers the data at least once each cycle and writes these records to a log file. Each file collects the record of one day and is automatically sent by email once a day.

### II. RESULTS

All the tests have been performed by an external independent company named Barthel HF Technik located in Aachen, Germany.

#### II.1. HiQ Capacitors – B Size (1111) – Solderable Nickel Barrier

The CHB series RF/Microwave capacitors offer both extended operating temperatures up to 175°C and extended voltages up to 1500 VDC. These components are based on our well-known P100 HiQ dielectric, a low loss material, which is ESA and MIL qualified -ITAR free.

On May the 9th 2011, the test set was completed without any problem to report.



#### II.2. HiQ Capacitors – X Size (2225) – Non Magnetic Solderable Barrier

The CLX series High RF Current/Voltage capacitors offer both ultra stability over temperature and extended voltages up to 3 600 VDC. These components are based on our well-known NPO HiQ dielectric, a low loss and ultra stable material, which is MRcertified® and MIL qualified - ITAR free.

# General Information

On November the 9th 2011, the test set was completed without any problem to report.



### III. CONCLUSIONS

These tests have shown the reliability of Temex-Ceramics capacitors in operation. Each of the HiQ capacitors under test has been exposed during 4 months to their maximum RF power signal rating, heated up to 125°C continuously and without any failure or event to report.

This endurance test, along with the European Space Agency qualification (see ESA.pdf on our website), the regular life test performed on standard production lots (see Reliability\_Data.pdf) and the MIL class R rating (see MIL.pdf) highlight, the high quality and reliability associated with EXXELIA capacitors.

### IV. APPENDIX

The capacitance of the capacitor under test may vary during the temperature ramp up time. Additionally it may vary if there is a beginning of destruction process. If the frequency was kept constant, the RF power coupled into the capacitor under test will decrease. Hence the temperature control loop will increase the RF power.

This may lead to a situation where the temperature decreases when the RF power cannot be increased any more. In order to cope with this, there is a second control loop that varies the frequency in order to minimize the reflected power. So the RF power amplifier stage will always be able to deliver the necessary power to keep the temperature constant.

As PC board, a ceramic material from Rogers is used, the R04350 material. Comparing to the standard FR4 material the ceramic board has the following advantages: improved heat conductivity; improved heat resistance and improved electrical strength.

Due to the improved electrical strength, it was possible to have a ground plane on the bottom side of the board. The coupler bar rests on a PTFE insulation. It was meant to be a heat insulation. However, during pre-tests, it became apparent that the PTFE material spreads the heat more than expected. In order to improve the heat insulation towards ground and the ambient air, the complete setup is now surrounded by a layer of glass wool.

All these efforts led to the following results: the temperature difference between the RF on time and the RF off time is less than 10°C and a total RF power of approximately 35 Watts is sufficient to heat the capacitors to 125°C. The capacitors under test are soldered with a non lead solder, Sn95Ag4Cu1 which has an extended temperature range also. Figure 4 shows the test setup.

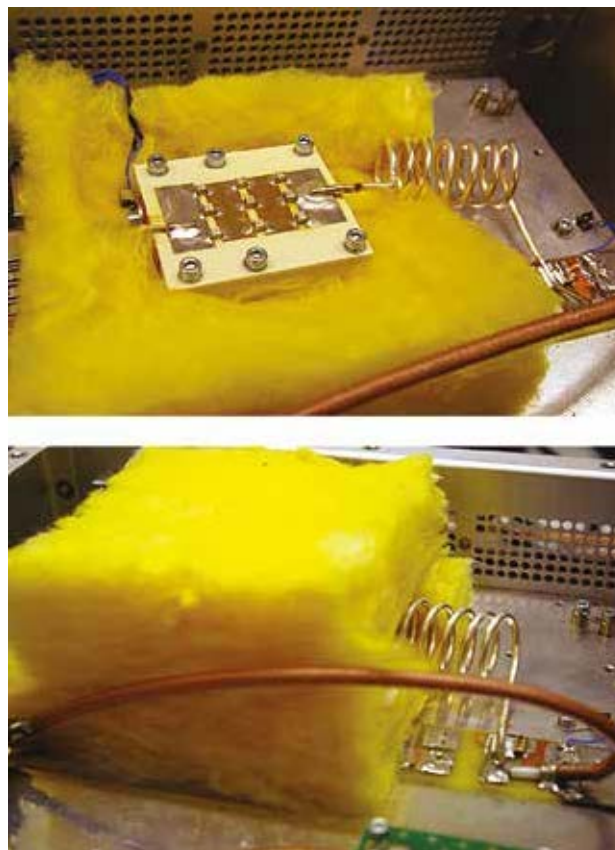

Figure 4

Both control loops are realized by a micro controller. Additionally, the micro controller provides an RS-232 interface to set some configuration values. A LC display shows warning messages also and some status information like temperature, RF power, etc.

The test generator works completely self sustained. It controls the temperature, RF power, frequency and all other parameters. The test generator takes also care that it remains itself within safe limits like maximum cool plate temperature, maximum forward power, maximum reflected power, frequency within a given bandwidth, etc. The test generator is connected to a remote computer.

# General Information

## NON MAGNETIC CAPACITORS ULTRA-LOW ESR, RF & MICROWAVE SYSTEMS

In today's world of medical systems, there is a trend in MRI equipment to increase the magnetic field – mostly from 1.5T to 3.0T. The higher signal strength obtained can then be translated into higher spatial resolution, enabling doctors to see finer details on the images. Whence the importance of non magnetic properties in the electronic components used in such systems.



At present, components with a significant magnetic response create parasitic black dots on the images, which may result in inaccurate or more difficult diagnosis – for instance the electrolytic capacitors aluminum or tantalum-based (paramagnetic). Not only this, but magnetic losses will overheat the system and reduce the reliability of the electronic components. Problems such as these - system temperature and component reliability - due to a significant magnetic response can moreover occur in any electronic equipment, though usually with a lower level of criticality.

To further improve reliability in such systems:

The electronic components used in MR systems, like the multilayer ceramic capacitors from EXXELIA, must have a very low magnetic response (diamagnetic);

A classification is needed for R&D engineers designing such systems, to quantify the magnetic response. This way, any component used in new developments – irrespective of its configuration, with wires or ribbons, etc. - would be guaranteed for MR applications;

Non magnetic components should also be proposed for non medical applications involving high RF power, so as to minimize losses and thereby improve the overall system performance.

The comprehensive magnetic study described below was conducted by the I.C.M.C.B. (the Bordeaux Institute of Chemistry of condensed materials), a laboratory under the aegis of the C.N.R.S. (French National Center for Scientific Research).



<http://www.cnrs.fr/index.html>

### I. MAGNETIC FIELD NOTIONS

#### I.1. Magnetic Permeability

This is the degree of magnetization of a material that responds linearly to an applied magnetic field. The magnetic permeability ( $\mu$ ) of a given material is related to the permeability of vacuum ( $\mu_0$ , in Henries per meter) times its relative permeability ( $\mu_R$ , no unit):

$$\mu = \mu_0 \times \mu_R$$

$\mu_0$  is a universal constant, the magnetic constant, and has the value.

$$4\pi \times 10^{-7} \text{ H/m}$$

$\mu_R$  is related to the material under test.

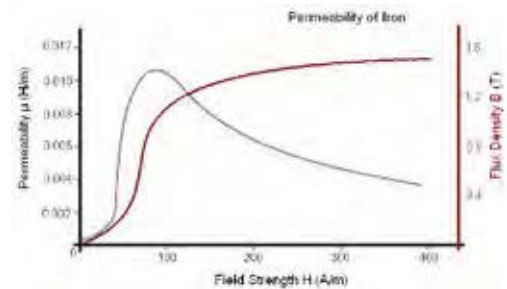

In vacuum, air, gases, ...  $\mu_R$  is equal to 1. These materials do not modify magnetic field lines. There are three types of materials:

Diamagnetic (silver, copper, gold, lead, ...) in which  $\mu_R \leq 1$  and close to 1

Paramagnetic (platinum, aluminum, magnesium, ...) where  $\mu_R \geq 1$  and close to 1

Ferromagnetic (nickel, cobalt, iron, ...) with  $\mu_R \gg 1$

#### I.2. Paramagnetism

Paramagnetism is a form of magnetism which occurs only in the presence of an externally applied magnetic field. Paramagnetic materials are attracted to magnetic fields, and hence have a relative magnetic permeability  $\mu_R$  greater than one - or, equivalently, positive magnetic susceptibility. However, unlike ferromagnets, which are also attracted to magnetic fields, paramagnets do not retain any magnetization in the absence of an externally applied magnetic field.

#### I.3. Diamagnetism

Diamagnetism is a weak repulsion from a magnetic field. It is a form of magnetism that is exhibited by a substance only in the presence of an externally applied magnetic field. All materials show a diamagnetic response in an applied magnetic field but for materials which show some other form of magnetism (such as ferromagnetism or paramagnetism), the diamagnetism is completely overpowered.



# General Information

Substances which display only, or mostly, diamagnetic behavior are termed diamagnetic materials, or diamagnets. Materials referred to as diamagnetic are those which are usually considered by non-physicists as “non magnetic”, and include water, DNA, most organic compounds such as petroleum and certain plastics, and many metals such as mercury, gold and bismuth.

## I.4. Ferromagnetism

Ferromagnetism is defined as the phenomenon by which materials, such as iron, in an external magnetic field, become magnetized and remain so for a period after the material is no longer in the field.

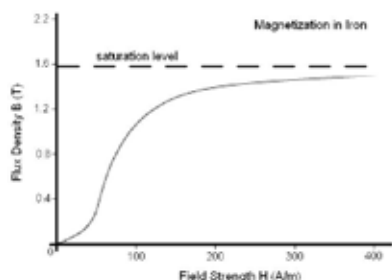

## I.5. Magnetic Susceptibility

Magnetic susceptibility ( $X_v$ ) is the degree of magnetization of a material in response to an applied magnetic field. If  $X_v$  is positive, then  $(1+X_v) > 1$  and the material is said to be paramagnetic. In this case, the magnetic field is strengthened by the presence of the material. Conversely, if  $X_v$  is negative, then  $(1+X_v) < 1$ , and the material is termed diamagnetic. As a result, the magnetic field is weakened in the presence of the material.

Class	$X_v$ dependant on B?	Dependent on temperature?	Hysterisis?	Example	$X_v$
Diamagnetic	No	No	No	Water	$-9 \times 10^{-6}$
Paramagnetic	No	Yes	No	Aluminum	$2.2 \times 10^{-5}$
Ferromagnetic	Yes	Yes	Yes	Iron	3000

## I.6. Units

The International System of Units [abbreviated “SI” from the French “Système International d’unités”] is the modern form of the metric system. It is the world’s most widely used system of units, both in everyday commerce and in science. The older metric system included several base units. The SI was developed in 1960 from the old meter-kilogram-second (MKS) system, rather than the centimeter-gram-second (CGS) system, which, likewise, had a number of variants.

The SI introduced several newly named units. The SI is not static, but a living set of standards in which units are created and definitions are modified through international agreement as the technology of measurement progresses.

Parameter	CGS System	Correcting Factor	SI unit
Magnetic Induction B	G (gauss)	$10^{-4}$	T (tesla)
Applied Field H	Oe (oersted)	$10^3/4\pi$	A/m
Magnetization Mg	emu/erg/G	1	A.m <sup>2</sup> /kg
Mass Susceptibility Xg	cm <sup>3</sup> /g	$4\pi \times 10^{-3}$	m <sup>3</sup> /kg
Permeability $\mu$	–	$4\pi \times 10^{-7}$	H/m

NB: when a material is paramagnetic, the best way to describe it is in terms of magnetic susceptibility Xg. When the material is ferromagnetic, magnetization Mg is preferred. The following formula could be used:

$$Mg = Xg \times H$$

One should also note that:

$$Xv = Xg \cdot [\text{density}]$$

## II. EXPERIMENTAL SETUP

### II.1. Magnetometer

Measurements were taken using a Quantum Design magnetometer, model MPMS-5. The MPMS provides solutions for a unique class of sensitive magnetic measurements in key areas such as high-temperature superconductivity, biochemistry and magnetic recording media. This began developing significantly in 1988 with the discovery of a new class of superconducting materials. While the basic application has not changed greatly, its use has expanded to more than 530 installations worldwide.

The modular MPMS design integrates a SQUID detection system - Superconducting Quantum Interference Device, a precision temperature control unit residing in the bore of a high field superconducting magnet, and a sophisticated computer operating system:

- Maximum Sample Size: 9 mm;
- Field Uniformity: 0.01% over 4 cm;
- Temperature Range: 1.9-400 K;
- Sensitivity of  $10^{-7}$  emu-CGS.

### II.2. Superconducting Quantum Interference Device

The main components of a SQUID (see Fig. 1) magnetometer are: (a) a superconducting magnet; (b) a superconducting detection coil which is coupled inductively to the sample; (c) a SQUID connected to the detection coil; (d) a superconducting magnetic shield. A description of each one is given below:



Fig. 1

### II.2.1. Superconducting Magnet

A superconducting magnet is a solenoid made of superconducting wires (see Fig. 2). The solenoid must be kept at liquid helium temperature in a liquid-helium medium. The uniform magnetic field is produced along the axial cylindrical bore of the coil. Superconducting solenoids that produce magnetic fields in the range 5-18 Tesla are now commercially available. A superconducting magnet requires an appropriate programmable bipolar power supply for operation.



Fig. 2

# General Information

## II.2.2. Superconducting Detection Coil

This is a single piece of superconducting wire, configured as a second-order gradiometer (see Fig. 3). This pick-up coil system is placed in the uniform magnetic field region of the solenoidal superconducting magnet.



Fig. 3

## II.2.3. SQUID

High sensitivity is possible because this device responds to a fraction of the flux quantum. The SQUID device is usually a thin film that functions as an extremely sensitive current-to-voltage-converter. A measurement is taken in this equipment by moving the sample through the second-order gradiometer. Hence, the magnetic moment of the sample induces an electric current in the pick-up coil system. A change in the magnetic flux in these coils modifies the persistent current in the detection circuit. The current change in the detection coils then produces a variation in the SQUID output voltage proportional to the magnetic moment of the sample.

## II.2.4. Superconducting Magnetic Shield

This is used to shield the SQUID sensor from the fluctuations of the ambient magnetic field in the magnetometer's location and from the large magnetic field produced by the superconducting magnet.

## II.2.5. Applications

This kind of equipment can be used to measure: (a) the real and imaginary components of the AC magnetic susceptibility as a function of frequency, temperature, AC magnetic field amplitude and DC magnetic field value; (b) the DC magnetic moment as a function of temperature, DC magnetic field, and time.

## II.3. Capsule Magnetization

The sample under testing has to be placed in a small capsule of 5-mm diameter and 8-mm length. Submitted to a magnetic field, the sample acquires a magnetization. The capsule is then placed in a 6-cm tube which results in a field strength variation. This is then measured in the SQUID and converted into a magnetization (uem.CGS unit in our case). Thin paper is used to secure the sample in place inside the capsule. Measurements were made with a controlled temperature (298.0±0.1K) and in the 0 to 3.5T range (35'000 Oe) as the magnetic field declined.

The first step before measuring any sample is to define the magnetization of the sample carrier, i.e. the capsule with some thin paper. Then, as the samples are measured, all the magnetization values are corrected using the pattern below:

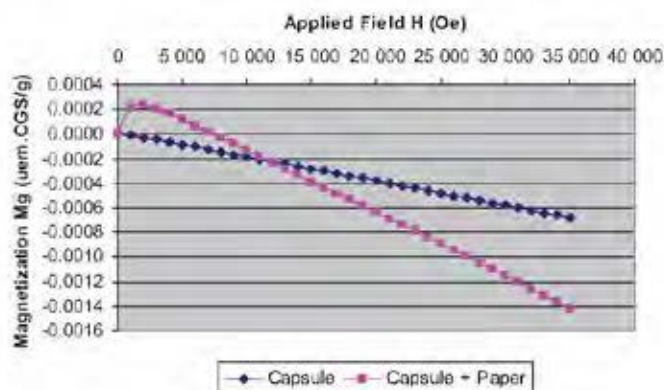

The signal from the capsule is diamagnetic and very weak. The signal from the capsule + the paper assembly is more complex to determine, combining a strong diamagnetic signal and a small ferromagnetic contribution (impurities in the paper material).

A constant corrective factor was then applied on all the measurements as a first approximation.

## III. LABORATORY MEASUREMENTS

The aim of this study is to define a range of magnetization values within which electronic components may be considered as non-magnetic and suitable for critical medical and high RF power applications.

Several components were therefore tested to define a spectrum as wide as possible. For instance, if we consider the high-Q multilayer ceramic capacitor: we started with the chip alone, without even its terminations, adding a new variable - such as copper or silver-palladium or nickel terminations, silver ribbons and finally laser marking - at each subsequent stage. Using this protocol, it is easy to see the effect of each variable on the final magnetization.

The magnetization in the charts below is given per gram. Each sample - or set of samples - is then weighed before the test run. The following designs were tested:

Designation	Number of Samples	Weight (mg)	Batch Number
501 CHB 4R7	3	155.1	C706527
501 CHB 4R7 BC	1	61.5	C649212
501 CHB 4R7 BC1L	1	133.6	C649212-0
501 CHB 4R7 BAL	1	57.5	52196
501 CHB 4R7 BS	1	61.2	C645208-2
silver leads type 1	2	55.4	CK/6297
silver leads type 2	2	57.2	CK/BC/2205
AT9401	1	58.6	OT0041006P
AT9402	1	60.8	OT011206P
AT9410	2	194.0	OT0020806P

The descriptions of the samples used are as follows:

- 501 CHB 4R7 B size [111] capacitor, 4.7pF, no termination
- 501 CHB 4R7 BC B size [111] capacitor, 4.7pF, copper termination
- 501 CHB 4R7 BC1L B size [111] capacitor, 4.7pF, copper termination, leads
- 501 CHB 4R7 BAL B size [111] capacitor, 4.7pF, silver-palladium termination
- 501 CHB 4R7 BS B size [111] capacitor, 4.7pF, nickel termination
- silver leads type 1 silver leads used with B size capacitors
- silver leads type 2 silver leads currently undergoing qualification
- AT940 ceramic trimmer capacitor, 0.6 to 2.0pF, gold termination
- AT9402 ceramic trimmer capacitor, 1.0 to 5.0pF, gold termination
- AT9410 ceramic trimmer capacitor, 4.0 to 18pF, gold termination

### III.1. DUT: 501 CHB 4R7

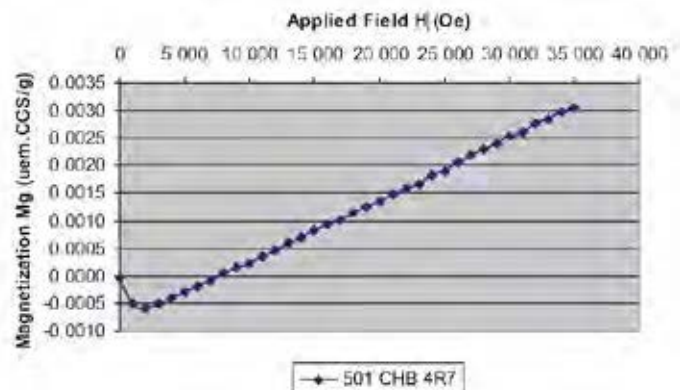

This sample shows a slightly paramagnetic behavior. Its magnetic susceptibility  $X_g$  is around  $10^{-7}$  uem.CGS/g which is a very low value.

# General Information

### III.2. DUT: 501 CHB 4R7 BC

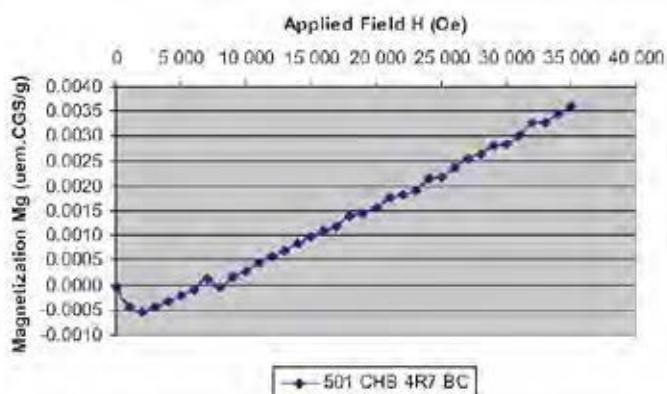

This sample has a slightly paramagnetic behavior. Its magnetic susceptibility  $X_g$  is around  $10^{-7}$  uem.CGS/g which is a very low value.

### III.3. DUT: 501 CHB 4R7 BS

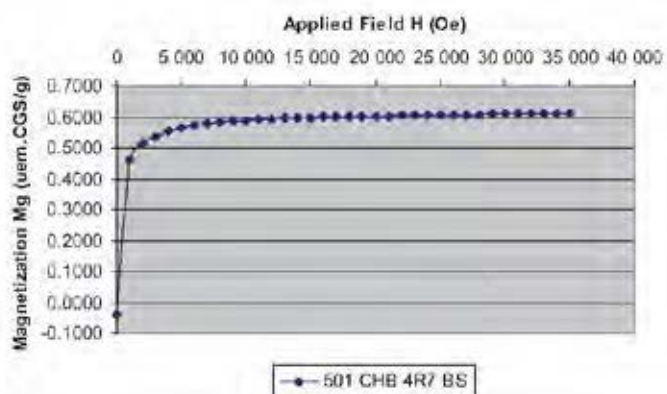

This sample exhibits a very strong magnetic behavior with a magnetization around 0.6 uem.CGS/g.

### III.4. DUT: 501 CHB 4R7 BAL

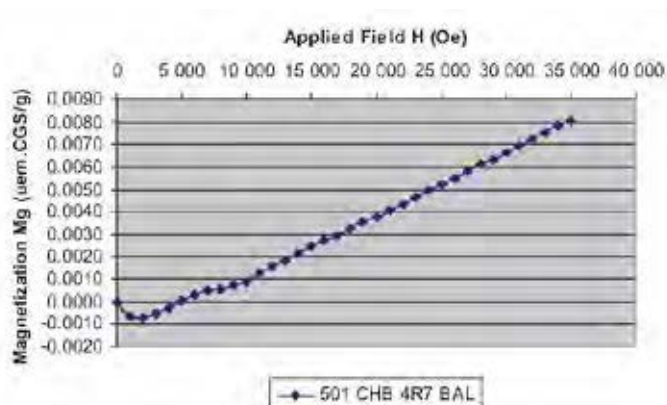

This sample has paramagnetic behavior with a magnetic susceptibility  $X_g$  around  $2.3 \times 10^{-7}$  uem.CGS/g.

### III.5. DUT: 501 CHB 4R7 BC1L

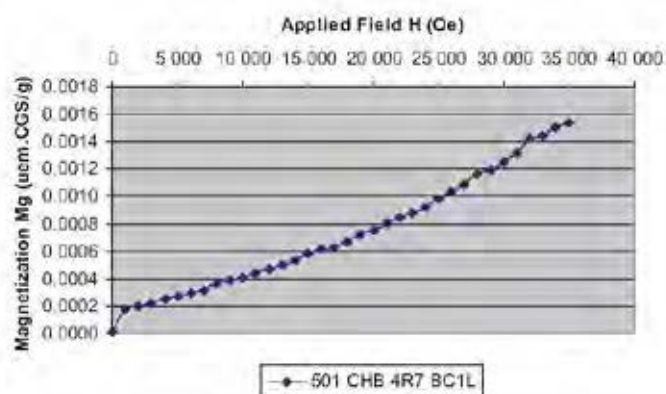

This sample shows a paramagnetic behavior with a magnetic susceptibility  $X_g$  around  $0.4 \times 10^{-7}$  uem.CGS/g.

### III.6. DUT: SILVER LEADS

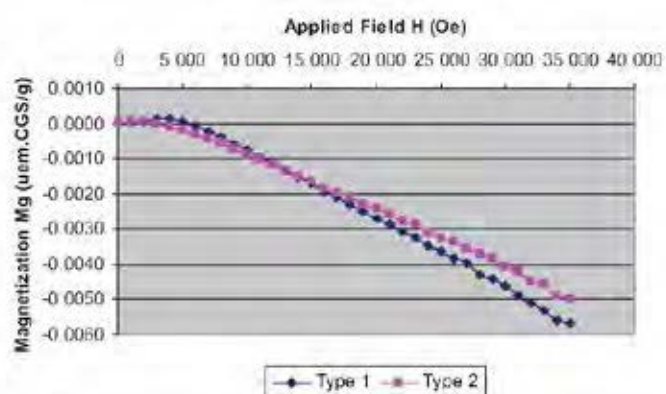

These two samples exhibit very similar diamagnetic behavior. The magnetic susceptibility  $X_g$  is in both cases around  $-1.6 \times 10^{-7}$  uem.CGS/g.

### III.7. DUT: AT9401

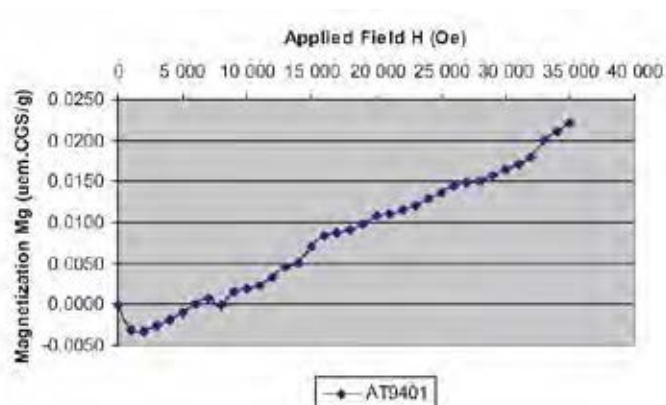

This sample has a paramagnetic behavior with a relatively high magnetic susceptibility  $X_g$ , around  $7.1 \times 10^{-7}$  uem.CGS/g.

# General Information

### III.8. DUT: AT9402

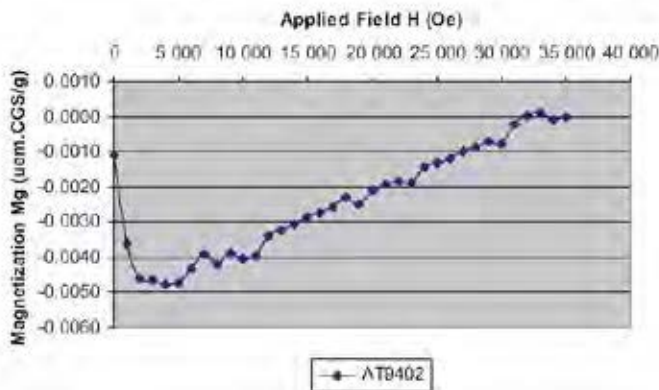

This sample has a paramagnetic behavior with a relatively low magnetic susceptibility  $X_g$  around  $10^{-7}$  uem.CGS/g.

### III.9. DUT: AT9410

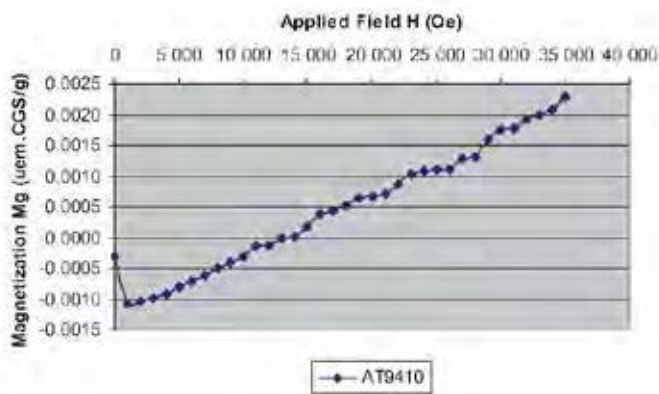

This sample has a paramagnetic behavior with a relatively low magnetic susceptibility  $X_g$  around  $10^{-7}$  uem.CGS/g.

## IV. ANALYSIS

### IV.1. Influence Of Leads

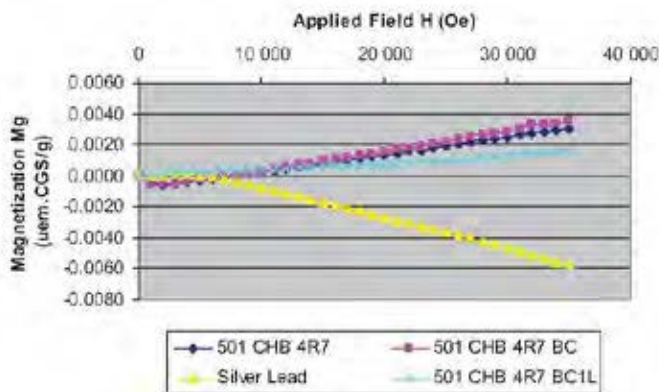

From the above chart, the following points may be deduced:

The copper termination slightly increases the magnetic susceptibility of the chip but the total value remains very low and the paramagnetic behavior is suitable for non-magnetic applications;

As the ribbon shows strong paramagnetic behavior, the assembly made with the capacitor and the leads has an even lower magnetic susceptibility than the chip alone. This means that for a very strong requirement for non-magnetic criteria, the assembly made of capacitor and leads is better than the capacitor itself;

In theory, it should be possible to decrease the magnetic susceptibility of the assembly – capacitor and leads – still further to reach a nearly a nil value, by using thicker or longer silver leads. These would also improve the heat transfer and therefore allow higher working power.

## IV.2. INFLUENCE OF TERMINATIONS

### IV.2.1. Copper Versus Nickel Terminations

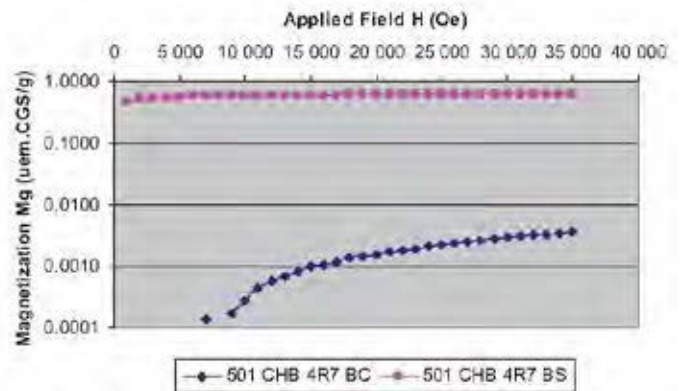

From the above chart, the following points may be deduced:

We are comparing here a magnetic termination – nickel barrier one – and a non-magnetic termination – copper barrier one. Naturally, the nickel termination cannot be used for non-magnetic applications but it enables us to define a limit above which a termination should not be classified as non-magnetic;

As we are using a logarithmic axis, the best magnetization value to consider for this limit seems to be around 0.10 uem.CGS/g;

Both copper and silver-palladium terminations are below this theoretical limit of 0.10 uem.CGS/g and can therefore be considered as non-magnetic.

### IV.2.2. Copper Versus Silver-Palladium Terminations

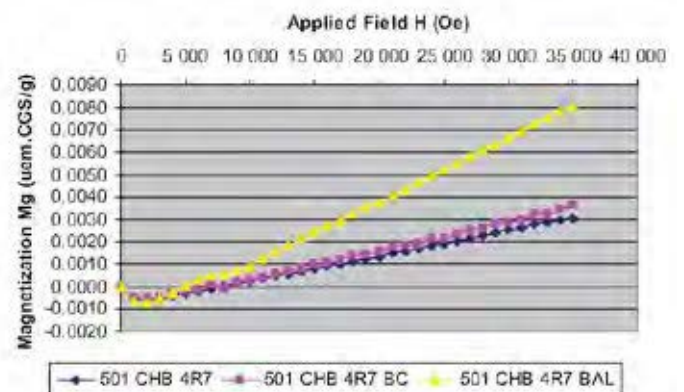

From the above chart, the following points may be deduced:

The copper or silver-palladium terminations slightly increase the magnetic susceptibility of the chip but the total value remains very low and the paramagnetic behavior is suitable for non-magnetic applications;

# General Information

The capacitor with silver-palladium terminations exhibits a magnetic susceptibility around three times higher than that of the capacitor with copper terminations. This means that for a very strong requirement for non-magnetic criteria, the copper terminations are better than the silver-palladium ones;

Both these terminations are suitable for non-magnetic applications as their magnetization is always below 0.10 uem.CGS/g.

### IV.3. Trimmer Capacitors

On the basis of the 0.10 uem.CGS/g limit previously discussed, the behavior of ceramic trimmer capacitors could also be studied.

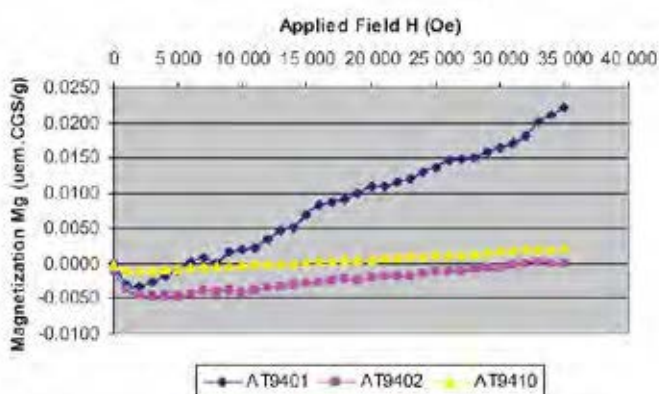

From the above chart, the following points may be deduced:

These three ceramic trimmer capacitors are all suitable for non-magnetic applications, as their magnetization is always below 0.10 uem.CGS/g;

The AT9402 and AT9410 exhibit very good paramagnetic behavior and are therefore recommended for applications with a very strong non-magnetic requirement.

### IV.4. PERMEABILITY

#### IV.4.1. Definitions

Some engineers prefer to define the magnetic behavior of a component using its permeability. Therefore, an empirical limit above which components are not suitable for non-magnetic applications seems to have been set at 1.0005 for the relative permeability  $\mu_r$ .

This relative permeability could be deduced from our measurements using the following method:

- Mass susceptibility  $X_g$  is given by the slope of the  $M_g = f(H)$  curve
- Volume susceptibility  $X_v$  is equal to:  $X_g \times [\text{density}]$
- Relative permeability is finally equal to:  $1 + X_v$

#### IV.4.2. Examples

Let's consider the 501 CHB 4R7 BC we measured previously. From the experimental curve, we find a mass susceptibility  $X_g$  of  $10^{-7}$  uem.CGS. As our components exhibit a density around 4, the volume susceptibility  $X_v$  is then equal to  $4 \times 10^{-7}$  uem.CGS. Finally, permeability  $\mu_r$  is then equal to 1.0000004, which is well below the theoretical limit of 1.0005

Even if there is no mass susceptibility  $X_g$  for a magnetic component – except at very low fields but customer's applications are far above this range – we can run the exercise for the 501 CHB 4R7 BS studied previously. From the first two dots on the experimental curve, we find a mass susceptibility  $X_g$  of  $0.5 \times 10^{-3}$  uem.CGS. As our components exhibit a density around 4, the volume susceptibility  $X_v$  is then equal to  $2 \times 10^{-3}$  uem.CGS. Finally, permeability  $\mu_r$  is then equal to 1.002, which is, as expected, well above the theoretical limit of 1.0005

### V. CONCLUSIONS

C.N.R.S. and EXXELIA have conducted a comprehensive study of the non-magnetic behavior of electronic components. This document describes the results of that study on multilayer porcelain capacitors and ceramic trimmer capacitors.

It flags up the following points:

The measurements made on magnetic and non-magnetic components enable us to define a first limit for magnetization of around 0.10 uem.CGS/g above which components can no longer be rated as non-magnetic;

All our non-magnetic components – both porcelain capacitors and ceramic trimmer capacitors – are below this limit and are therefore Magnetism-free Rated. To enable R&D engineers to quickly distinguish in the EXXELIA portfolio which components are guaranteed for non-magnetic applications, the following specific logo will be added to specific series in our Application datasheets:



The above logo certifies that a specific electronic component is Magnetism-free Rated;

Concerning non-magnetic applications - mainly medical systems -, the best solution to obtain a very low magnetization ceramic capacitor is to use one with copper terminations;

The silver leads, made from pure silver, are completely non-magnetic;

Concerning standard applications like telecom, industrial, military or space systems, as any system induces a magnetic field, the use of non-magnetic components would rule out magnetic losses and therefore improve the overall performances, particularly in switch-mode operations.

# General Information

## MATERIALS EXPERT

For 50 years and as a market leader, EXXELIA's comprehensive knowledge of the materials properties and performances have enabled us to design capacitors in Porcelain, NPO, BX, 2C1, BP, X7R and –2200ppm/°C ceramics.

## CUSTOM DESIGNS

Our catalog products don't meet your application?

Based on the valuable experience accumulated over the design of 2,000+ specific ceramic capacitors, you can trust EXXELIA to define a qualitative custom solution in a time effective manner.

## NO OBSOLESCENCE

Choosing a standard or custom EXXELIA product means you won't have to worry about obsolescence.

## TYPICAL APPLICATIONS

- Aerospace & Defense: cockpit panels, flight control, radio systems, missile guidance systems...
- Space: military and commercial satellites, launcher...
- Medical: MRI, external defibrillators, implantable devices...
- Telecommunications: base stations...
- Oil and gas: drilling tools, MWD, LWD, wellheads...

## ISO 9001 AND AS9100C

Quality is at the core of Exxelia's corporate culture. Each sites has its own certifications.

## CERTIFICATIONS

Capacitors manufactured by EXXELIA comply with American and European standards and meet the requirements of many international standards.

For Space qualified parts (ESA QPL), please refer to our catalog «Ceramic capacitors for Space applications».

## QUALITY & RELIABILITY

EXXELIA is committed to design and manufacture high quality and reliability products. The test cycles reproducing the most adverse operating conditions over extended periods (up to 10 000 hours) have logged to date well over 5.10<sup>9</sup> hours/Component.

Failure rate data can be provided upon request.

## CONFLICT MINERALS

EXXELIA is committed to an approach based on «Conflict Minerals Compliance». This US SEC rule demands complete traceability and a control mechanism for the mineral procurement chain, encouraging importers to buy only «certified» ore.

We have discontinued relations with suppliers that procure from the Democratic Republic of the Congo or an adjoining country.

## ENVIRONMENT

EXXELIA is committed to applying a robust environmental policy, from product design through to shipment. To control its environmental footprint and reconcile this with the company' functional imperatives, our environmental policy provides for the reduction or elimination of hazardous substances. We also focus on compliance with European Union directives and regulations, notably REACH and RoHS.

## RoHS COMPLIANCY

### SMD CAPACITORS

The capacitor terminations are generally protected by a nickel barrier formed by electrolytic deposit. This barrier gives chip capacitors leaching performance far exceeding the requirements of all applicable standards. The nickel barrier guarantees a minimum resistance to soldering heat for a period of 1 minute at 260°C in a tin-lead (60/40) or tin-lead-silver (62/36/2) bath without noticeable alteration to the solderability. It also allows repeated soldering-unsoldering and the longer soldering times required by reflow techniques.

However nickel barrier amplifies thermal shock and is not recommended for chip sizes equal or greater than CNC Y (30 30) - (C 282 to C 288 - CNC 80 to CNC 94).

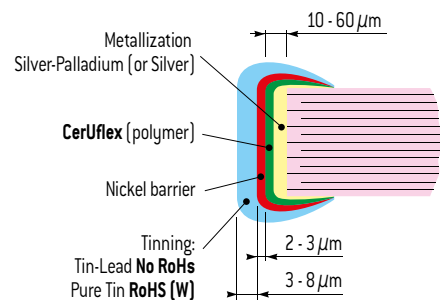















### LEADED COMPONENTS

As well as for SMD products, leaded capacitors ranges can also be RoHS. These products, which are characterized by the suffix «W» added to the commercial type, are naturally compatible with the soldering alloys used in RoHS mounting technology. The connections coating is generally an alloy SnAg (with a maximum of 4% Ag). However, on a few products that EXXELIA will precise on request, the coating is pure silver.

# Selection Guide

Main Characteristic	Model	Size	Dielectric	Voltage	Capacitance	Temperature	Coating					Leads				Mounting		Main Applications	Page	
							Uncoated	Varnished	Conformal coated	Molded	Self-protected	DIL	Ribbon	Axial	Radial	SMD	Through hole			
STANDARD	<b>CEC / CNC SERIES</b> Low and Medium Voltage Chips Capacitors	0402 to 3040	NPO BX 2C1 X7R	10V to 1,000V	1pF to 12μF	-55°C to +125°C	•											Precision, stability, decoupling	22	
	<b>NON MAGNETIC CHIPS SERIES</b> Low and Medium Voltage Chips Capacitors	0505 to 2220	NPO X7R	50V to 500V	10pF to 1μF	-55°C to +125°C	•											Precision, stability, decoupling	26	
	<b>OP SERIES</b> Open Mode Chips Capacitors	0805 to 2220	NPO X7R	10V to 100V	1pF to 4.7μF	-55°C to +125°C	•											Precision, stability, decoupling, Significantly reduce risk of short circuit	28	
	<b>CER / CNR SERIES</b> Low Inductance Chips Capacitors	0306 to 0612	NPO X7R	16V to 100V	1pF to 270nF	-55°C to +125°C	•												Decoupling, low ESL, medical embedded	30
	<b>C3N / C4N / C3E / C4E SERIES</b> Capacitors Arrays	-	NPO X7R	25V to 200V	4.7pF to 33nF	-55°C to +125°C	•												Medical embedded, miniaturisation	32
	<b>30 S4 SERIES</b> Safety Capacitors	-	NPO X7R	40V to 100V	470pF to 820nF	-55°C to +125°C	•				•								Railway	33
	<b>TCE / TCX / TCN / TXR MOLDED SERIES</b> Radial Molded Capacitors	-	NPO BX 2C1 X7R	25V to 500V	1pF to 4.7μF	-55°C to +125°C			•										Precision, stability, decoupling	34
	<b>LA SERIES</b> Radial Molded Capacitors	-	NPO Temp. coeff.	25V to 63V	1pF to 680nF	-55°C to +125°C				•									Decoupling	36
	<b>TCE / TCX / TCN / TXR AXIAL SERIES</b> Axial Molded Capacitors	-	NPO BX - 2C1 X7R	25V to 500V	1pF to 3.9μF	-55°C to +125°C				•									Precision, stability, decoupling	38
	<b>TCE / TCX / TCN / TXR CONFORMAL COATED SERIES</b> Radial Dipped Capacitors	-	NPO BX - 2C1 X7R	25V to 500V	1pF to 6.8μF	-55°C to +125°C			•										Precision, stability, decoupling	40
	<b>NON MAGNETIC CONFORMAL COATED SERIES</b> Radial Dipped Capacitors	-	NPO X7R	63V to 500V	180pF to 1μF	-55°C to +125°C			•										Precision, stability, decoupling	42
	<b>CK SERIES</b> Radial Molded Capacitors	-	BX	25V to 250V	10pF to 1μF	-55°C to +125°C				•									Decoupling	44
HIGH VOLTAGE	<b>C Series</b> High voltage chips Capacitors	1812 to 16080	NPO C4xx X7R	200V to 10kV	10pF to 39μF	-55°C to +125°C	•												51	
	<b>TCL / TCK Series</b> High voltage Molded & Varnished leaded Capacitors	-	NPO C4xx X7R	200V to 10kV	10pF to 39μF	-55°C to +125°C			•										54	
	<b>TCF Series</b> High voltage Conformal coated leaded Capacitors	-	NPO C4xx X7R	200V to 10kV	10pF to 39μF	-55°C to +125°C				•									57	
	<b>TKD Series</b> High voltage Conformal coated leaded Capacitors	-	NPO C4xx X7R	200V to 10kV	10pF to 39μF	-55°C to +125°C				•									60	
	<b>CS Series</b> High voltage Stacked Capacitors	2220 to 16080	NPO C4xx X7R	1kV to 10kV	220pF to 15μF	-55°C to +125°C	•	•			•	•							62	
																		Power supply, voltage multiplier, radars. • aerospace • space • defence • railways		

# Selection Guide

Main Characteristic	Model	Size range	Dielectric	Voltage range	Capacitance range	Temperature range	Coating					Leads				Mounting		Main Applications	Page
							Uncoated	Varnished	Conformal coated	Molded	Self protected	DIL	Ribbon	Axial	Radial	SMD	Through hole		
HIGH CAPACITANCE	<b>R SERIES (CHIPS)</b> High Capacitance Chips Capacitors 	2225 to 45107	X7R	50V to 500V	47nF to 27µF	-55°C to +125°C	•												73
	<b>R SERIES (LEADED)</b> Radial Leaded Conformal Coated Capacitors 	-	X7R	50V to 500V	47nF to 27µF	-55°C to +125°C			•					•					77
	<b>TEF SERIES</b> Radial Leaded Conformal Coated Capacitors 	-	NPO	63V to 500V	10nF to 680nF	-55°C to +125°C			•					•					80
	<b>SV / SC SERIES</b> High Capacitance Stacked Capacitors 	2225 to 125205	X7R	50V to 500V	47nF to 390µF	-55°C to +125°C	•	•			•	•			•	•			81
	<b>CNC3X SERIES</b> High Capacitance Stacked Capacitors 	2220 to 4040	X7R	16V to 25V	1.2µF to 68µF	-55°C to +125°C	•	•			•				•	•			88
	<b>CEC5X SERIES</b> High Capacitance Stacked Capacitors 	3033 to 80150	NPO	63V to 500V	10nF to 6.8µF	-55°C to +125°C	•	•			•				•	•			90
	<b>TEP / TEV SERIES</b> High Capacitance Stacked Capacitors 	-	NPO	63V to 500V	10nF to 6.8µF	-55°C to +125°C		•							•				93
<b>TCN8X SERIES</b> High Capacitance Molded Stacked Capacitors 	-	X7R	63V to 500V	0.47µF to 120µF	-55°C to +125°C				•					•				95	
HIGH TEMPERATURE	<b>CE / CN SERIES</b> High Temperature Chips Capacitors 	0402 to 3040	NPO to X7R	16V to 100V	1pF to 8.2µF	-55°C to +250°C	•												100
	<b>SCT SERIES</b> High Temperature Stacked Capacitors 	2225 to 125205	X7R	50V to 500V	47nF to 390µF	-55°C to +215°C	•	•			•				•	•			102
	<b>TCE / TCN MOLDED SERIES HT</b> High Temperature Molded Capacitors 	-	NPO to X7R	16V to 100V	1pF to 10µF	-55°C to +220°C				•					•	•			107
	<b>TCE / TCN SELF-PROTECTED SERIES</b> High Temperature Self-Protected Capacitors 	-	NPO to X7R	25V to 500V	10pF to 3.9µF	-55°C to +250°C					•				•	•			109
	<b>TCH SERIES</b> High Temperature High Voltage Capacitors 	-	NPO to X7R	200V to 10kV	10pF to 15µF	-55°C to +250°C		•							•				111
FEED-THRU	<b>TBC SERIES</b> Discoidal Capacitors 	-	NPO to X7R	25V to 1kV	10pF to 12µF	-55°C to +125°C	•											Very low ESL	115
	<b>BPM SERIES</b> Planar Array 	-	X7R	25V to 200V	330pF to 68nF	-55°C to +125°C	•												Very low ESL, miniaturisation

# Selection Guide

Main Characteristic	Model	Size range	Dielectric	Voltage range	Capacitance range	Temperature range	Coating					Leads				Mounting		Main Applications	Page
							Uncoated	Varnished	Conformal coated	Molded	Self protected	DIL	Ribbon	Axial	Radial	SMD	Through hole		
HIGH Q	<b>XBL SERIES</b> Broadband	0402	X7R	16V	100nF	-55°C to +125°C	•											DC Blocking, Coupling, Bypassing	138
	<b>UBL SERIES</b> Broadband	0402	X7R	16V	100nF	-55°C to +125°C	•												140
	<b>UBZ SERIES</b> Broadband	0201	X5R X6T	10V	100nF	-55°C to +105°C	•												142
	<b>CH SERIES</b> Classic HiQ	0505 1111	P100	50V to 1.5kV	0.1pF to 1nF	-55°C to +175°C	•				•		•	•				Cellular base station amplifier, MRI.	144
	<b>SH SERIES</b> Super HiQ	0402 to 1210	NPO	25V to 1.5kV	0.2pF to 1nF	-55°C to +150°C	•				•		•	•				Cellular base station equipment	147
	<b>SHD / SHR SERIES</b> Reverse Geometry	0709 0711	NPO	500V	0.5pF to 100pF	-55°C to +175°C	•								•			Broadband Point to point/ multi-point radios RF generators	150
	<b>NHB SERIES</b> High Self Resonant Frequency	1111	NPO	500V	0.3pF to 100pF	-55°C to +175°C	•								•				152
	<b>CP SERIES</b> High Power	2225 4040	P100	200V to 7kV	1pF to 10nF	-55°C to +125°C	•	•			•	•	•	•	•			RF power amplifier Plasma chamber MRI coils	154
	<b>CL SERIES</b> High Power	2225 to 7065	NPO	200V to 7kV	1pF to 10nF	-55°C to +125°C	•	•			•	•	•	•	•			RF power amplifier Plasma chamber MRI coils	158

## ADDITIONAL AVAILABLE RANGES (consult our website)

STANDARD	<b>TCE1X Series</b>	-	NPO	63V to 100V	0.5pF to 10nF	-55°C to +125°C				•								Precision, stability, decoupling	-
	<b>TCN19 Series</b>	-	2C1	63V to 250V	10pF to 1µF	-55°C to +125°C				•								Decoupling	-
	<b>TCN3X Series</b>	-	2C1	50V to 100V	100pF to 1,8µF	-55°C to +125°C				•									-
	<b>LA6 Series</b>	-	2C1	25V to 63V	100pF to 1µF	-55°C to +125°C				•									-
HIGH VOLT.	<b>H Series</b>	0805 to 6560	NPO X7R	1kV to 10kV	2pF to 390nF	-55°C to +125°C	•	•										Power supply, voltage multiplier, radars.	-
HIGH CAPACITANCE	<b>CNC5X Series</b>	3033 to 80150	X7R	63V to 500V	0,1µF to 180µF	-55°C to +125°C	•	•		•								Switch Mode Power Supply, filtering, smoothing, decoupling, aerospace, space, defence	-
	<b>CNC8X Series (chips)</b>	3033 to 33110	X7R	63V to 400V	47nF to 27µF	-55°C to +125°C	•												-
	<b>CNC8X Series (DIL)</b>	3333 to 80150	X7R	63V to 400V	47nF to 180µF	-55°C to +125°C	•	•		•									-
	<b>TCP / TCV8X Series</b>	3333 to 80150	X7R	63V to 400V	47nF to 180µF	-55°C to +125°C		•											-
	<b>TCP / TCV5X Series</b>	3033 to 80150	X7R	63V to 500V	0,1µF to 180µF	-55°C to +125°C		•											-
	<b>TCF Series</b>	-	X7R	63V to 500V	0,1µF to 18µF	-55°C to +125°C			•										-
HIGH TEMP.	<b>CNC25X Series</b>	3033 to 5550	X7R	50V	1µF to 33µF	-55°C to +200°C	•	•		•								Oil drilling, motor control, braking systems.	-
HIGH Q	<b>CNW Series</b>	-	X7R	100V to 300V	10nF to 1µF	-55°C to +125°C	•					•	•					Power amplifier	-
	<b>SPT519 / CAW CEW Series</b>	-	NPO	100V to 300V	10nF to 1µF	-55°C to +125°C	•	•											-

# Ceramic Capacitors Technology

## MLCC STRUCTURE

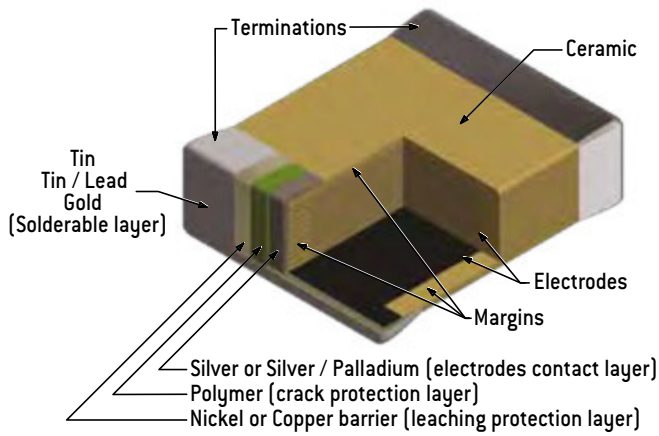

## EQUIVALENT CIRCUIT

Capacitor is a complex component combining resistive, inductive and capacitive phenomena. A simplified schematic for the equivalent circuit is:

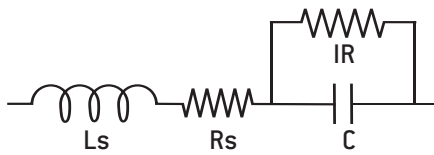

## DIELECTRIC CHARACTERISTICS

**Insulation Resistance (IR)** is the resistance measured under DC voltage across the terminals of the capacitor and consists principally of the parallel resistance shown in the equivalent circuit. As capacitance values and hence the area of dielectric increases, the IR decreases and hence the product (C x IR) is often specified in  $\Omega \cdot F$  or  $M\Omega \cdot \mu F$ .

**The Equivalent Series Resistance (ESR)** is the sum of the resistive terms which generate heating when capacitor is used under AC voltage at a given frequency (f).

**Dissipation factor (DF)** is the ration of the apparent power input will turn to heat in the capacitor:

$$DF = 2\pi f C ESR$$

When a capacitor works under AC voltage, **heat power loss (P)**, expressed in Watt, is equal to:

$$P = 2\pi f C V_{rms}^2 DF$$

**The series inductance (Ls)** is due to the currents running through the electrodes. It can distort the operation of the capacitor at high frequency where the **impedance (Z)** is given as:

$$Z = R_s + j (L_s \cdot \omega - 1 / (C \cdot \omega)) \text{ with } \omega = 2\pi f$$

When frequency rises, the capacitive component of capacitors is gradually canceled up to the resonance frequency, where :

$$Z = R_s \text{ and } L_s C \cdot \omega^2 = 1$$

Above this frequency the capacitor behaves like an inductor.

	P100	NPO	N2200 (C4xx)	BX	2C1	X7R
<b>Dielectric material</b>	Porcelain	Magnesium titanate or Neodymium baryum titanate	Barium zirconate titanate	Baryum titanate (BaTiO <sub>3</sub> )		
<b>Dielectric constant</b>	15 – 18	20 – 85	450	2,000 – 5,000		
<b>Electrode technology</b>	PME (Precious Metal Electrodes): Ag/Pd					
<b>Capacitance variation between –55°C and +125°C without DC voltage</b>	(100 ± 30)ppm/°C	(0 ± 30)ppm/°C	(–2,200 ± 500) ppm/°C	± 15%	± 20%	± 15%
<b>Capacitance variation between –55°C and +125°C with DC rated voltage</b>			0 -15%	15% –25%	20% –30%	Not applicable
<b>Piezo-electric effect</b>	None		None	Yes		
<b>Dielectric absorption</b>	None		Few %	Few %		
<b>Thermal shock sensitive</b>	+		+	++		

# Ceramic Capacitors Technology

## MANUFACTURING STEPS

SLIP CASTING



A slurry, a mix of ceramic powder, binder and solvents, is poured onto conveyor belt inside a drying oven, resulting in a dry ceramic sheet.

ELECTRODE SCREEN PRINTING

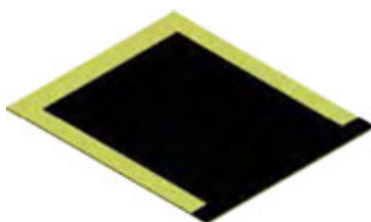

The electrode ink, made from a metal powder mixed with solvents, is printed onto the ceramic sheets using a screen printing process.

STACKING

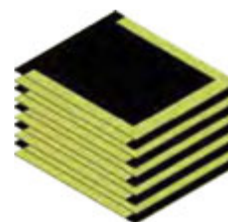

The sheets with electrode printed are stacked to create a multilayer structure.

TERMINATIONS

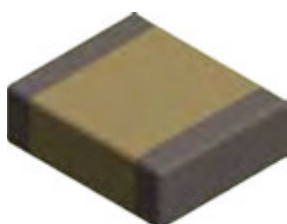

Each terminal of the capacitor is dipped in the termination ink, mix of metal powder, solvents and glass frit and the parts are fired in an oven.

SINTERING

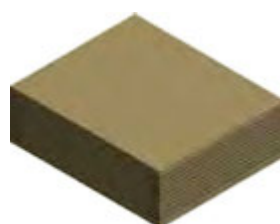

The parts are sintered in an oven with a precise temperature profile which is very important to the characteristics of the capacitors.

PRESSING

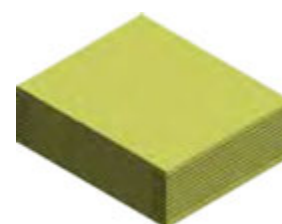

Pressure is applied to the stack to fuse all the separate layers, this created a monolithic structure.

TERMINATIONS PLATING

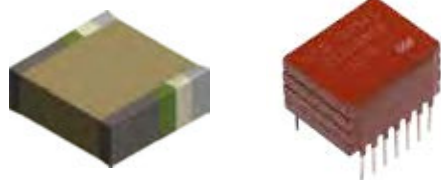

Stacking + leads soldering + encapsulation  
[see pages 10-11]

FINAL TESTING

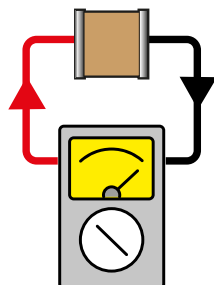

PACKAGING



# User Guide

## SMD TERMINATIONS

NON RoHS COMPLIANT	Code	RoHS COMPLIANT	Code	Recommended mounting process							Storage [months]*
				Magnetic	Epoxy bonding	Iron soldering	Wave soldering	Vapor phase soldering	Infrared soldering	Wire bonding	
Ag	<b>Q</b>	Ag	<b>QW / P</b>	No	•	•	•	•			18
Ag/Pd/Pt	-	Ag/Pd/Pt	<b>W / A</b>	No	•	•	•				24
Ag + Ni + dipped Sn/Pb 60/40	<b>T**</b>	-	-	No		•	•	•	•		24
Ag/Pd/Pt + dipped Sn/Pb 60/40	<b>H</b>	Ag/Pd/Pt + dipped Sn	<b>HW</b>	No		•					24
Ag + Ni + electrolytic Sn/Pb 95/5	<b>C</b>	Ag + Ni + electrolytic Sn	<b>CW / S</b>	Yes		•	•	•	•		18
Ag + Ni + electrolytic Sn/Pb 60/40	<b>D</b>	-	-	Yes		•	•	•	•		18
-	-	Ag + Cu + electrolytic Sn	<b>C***</b>	No		•	•	•	•		18
Ag + Ni + dipped Sn/Pb 60/40	<b>E</b>	Ag + Ni + electrolytic Sn	<b>EW</b>	Yes		•	•				24
Ag + Ni + Au	<b>G</b>	Ag + Ni + Au	<b>GW</b>	Yes	•	•	•	•	•	•	36
Ag + Polymer + Ni + Sn/Pb 95/5	<b>YC</b>	Ag + Polymer + Ni + Sn	<b>YCW</b>	Yes		•	•	•	•		18
Ag + Polymer + Ni + Sn/Pb 60/40	<b>YD</b>	-	-	Yes		•	•	•	•		18
Ag + Polymer + Ni + Au	<b>YG</b>	Ag + Polymer + Ni + Au	<b>YGW</b>	Yes	•	•	•	•	•	•	36

Nickel (Ni) or Copper (Cu) barriers amplify thermal shock and are not recommended for chip sizes larger than 3030.

\* Storage must be in a dry environment at a temperature of 20°C with a relative humidity below 50%, or preferably in a package enclosing a desiccant.

\*\* Maintenance only.

\*\*\* Non magnetic chips series only.

## SMD ENVIRONMENTAL TESTS

Ceramic chip capacitors for SMD are designed to meet test requirements of **CECC 32100** and **NF C 93133** standards as specified below in compliance with **NF C 20700** and **IEC 68** standards:

- Solderability: **NF C 20758**, 260°C, bath 62/36/2.
- Adherence: 5N force.
- Vibration fatigue test: **NF C 20706**, 20 g, 10 Hz to 2,000 Hz, 12 cycles of 20 minutes each.
- Rapid temperature change: **NF C 20714**, -55°C to + 125°C, 5 cycles.
- Combined climatic test: **IEC 68-2-38**.
- Damp heat: **NF C 20703**, 93 %, H.R., 40°C.
- Endurance test: 1,000 hours, 1.5 U<sub>RC</sub>, 125°C.

## STORAGE OF CHIP CAPACITORS

### TINNED OR NON TINNED CHIP CAPACITORS

Storage must be in a dry environment at a temperature of 20°C with a relative humidity below 50 %, or preferably in a packaging enclosing a desiccant.

### STORAGE IN INDUSTRIAL ENVIRONMENT:

- 2 years for tin dipped chip capacitors,
- 18 months for tin electroplated chip capacitors,
- 2 years for non tinned chip capacitors,
- 3 years for gold plated chip capacitors.

### STORAGE IN CONTROLLED NEUTRAL NITROGEN ENVIRONMENT:

- 4 years for tin dipped or electroplated chip capacitors,
- 4 years for non tinned chip capacitors,
- 5 years for gold plated chip capacitors.

Storage duration should be considered from delivery date and not from batch manufacture date. The tests carried out at final acceptance stage [solderability, susceptibility to solder heat] enable to assess the compatibility to surface mounting of the chips.

# User Guide

## LEAD STYLES

### SURFACE MOUNTING

#### DIL LEADS

P style



PL style



L style



J style

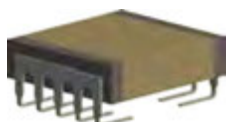

#### RIBBON LEADS

Micro-strip (type 1)  
Short Micro-strip (type 1S)

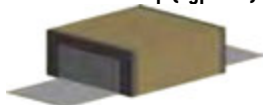

Axial (Type 2)



Radial (Type 3)



R style

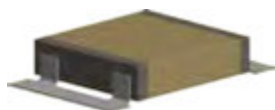

RX style

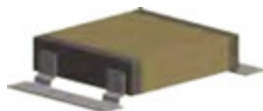

RJ style

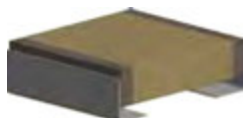

Please contact Exxelia sales for any lead configuration not shown.

### TROUGH-HOLE MOUNTING

#### AXIAL AND RADIAL

Radial leads (Type 6)



Radial leads (4 leads)



Axial leads (Type 7)



DIL leads: N style

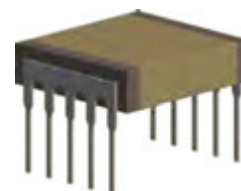

### ENCAPSULATION STYLES

Ceramic encapsulation  
(selfprotected)



Varnish



Conformal coating



Molding



# User Guide

## SOLDERING ADVICES FOR REFLOW SOLDERING

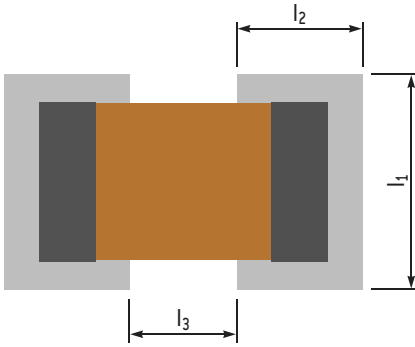

Large chips above size 2225 are not recommended to be mounted on epoxy board due to thermal expansion coefficient mismatch between ceramic capacitor and epoxy. Where larger sizes are required, it is recommended to use components with ribbon or other adapted leads so as to absorb thermo-mechanical strains.

Dimensions in inches (in mm)	Reflow soldering						Wave soldering					
	l <sub>1</sub>		l <sub>2</sub>		l <sub>3</sub>		l <sub>1</sub>		l <sub>2</sub>		l <sub>3</sub>	
0402	0.043	(1.1)	0.035	(0.9)	0.012	(0.3)	0.043	(1.1)	0.047	(1.2)	0.012	(0.3)
0403	0.055	(1.4)	0.035	(0.9)	0.012	(0.3)	0.055	(1.4)	0.047	(1.2)	0.012	(0.3)
0504	0.063	(1.6)	0.051	(1.3)	0.016	(0.4)	0.063	(1.6)	0.063	(1.6)	0.016	(0.4)
0603	0.055	(1.4)	0.059	(1.5)	0.02	(0.5)	0.055	(1.4)	0.071	(1.8)	0.02	(0.5)
0805	0.073	(1.85)	0.065	(1.65)	0.024	(0.6)	0.073	(1.85)	0.077	(1.95)	0.024	(0.6)
0907	0.094	(2.4)	0.065	(1.65)	0.035	(0.9)	0.094	(2.4)	0.077	(1.95)	0.035	(0.9)
1005	0.073	(1.85)	0.067	(1.7)	0.039	(1)	0.073	(1.85)	0.079	(2)	0.039	(1)
1206	0.083	(2.1)	0.067	(1.7)	0.059	(1.5)	0.083	(2.1)	0.079	(2)	0.059	(1.5)
1210	0.118	(3)	0.069	(1.75)	0.059	(1.5)	0.118	(3)	0.081	(2.05)	0.059	(1.5)
1605	0.073	(1.85)	0.071	(1.8)	0.087	(2.2)	0.073	(1.85)	0.083	(2.1)	0.087	(2.2)
1806	0.087	(2.2)	0.073	(1.85)	0.102	(2.6)	0.087	(2.2)	0.085	(2.15)	0.102	(2.6)
1812	0.152	(3.85)	0.073	(1.85)	0.102	(2.6)	0.152	(3.85)	0.085	(2.15)	0.102	(2.6)
1825	0.281	(7.15)	0.073	(1.85)	0.102	(2.6)	0.281	(7.15)	0.085	(2.15)	0.102	(2.6)
2210	0.13	(3.3)	0.079	(2)	0.146	(3.7)	0.13	(3.3)	0.091	(2.3)	0.146	(3.7)
2220	0.228	(5.8)	0.079	(2)	0.146	(3.7)	0.228	(5.8)	0.091	(2.3)	0.146	(3.7)
2225	0.281	(7.15)	0.079	(2)	0.146	(3.7)	0.281	(7.15)	0.091	(2.3)	0.146	(3.7)

### RECOMMENDED FOOTPRINT FOR SMD CAPACITORS

Ceramic is by nature a material which is sensitive both thermally and mechanically. Stresses caused by the physical and thermal properties of the capacitors, substrates and solders are attenuated by the leads.

Wave soldering is unsuitable for sizes larger than 2220 and for the higher ends of capacitance ranges due to possible thermal shock (capacitance values given upon request).

Infrared and vapor phase reflow, are preferred for high reliability applications as inherent thermo-mechanical strains are lower than those inherent to wave soldering.

Whatever the soldering process is, it is highly recommended to apply a thermal cycle, see hereafter our recommended soldering profile:

### RECOMMENDED VAPOR PHASE REFLOW PROFILE

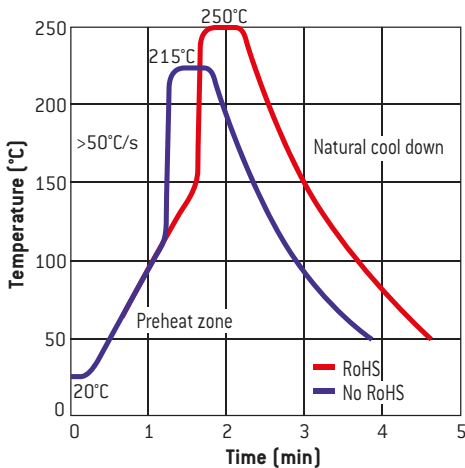

### RECOMMENDED IR REFLOW PROFIL

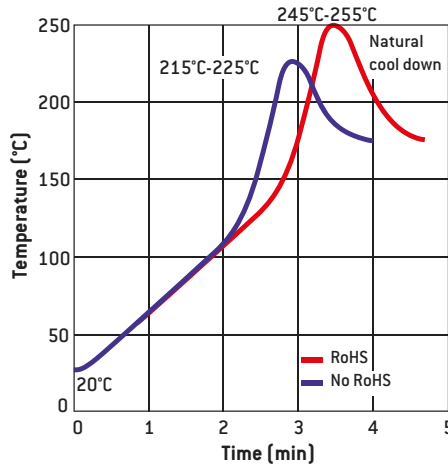

### RECOMMENDED WAVE SOLDERING PROFILE

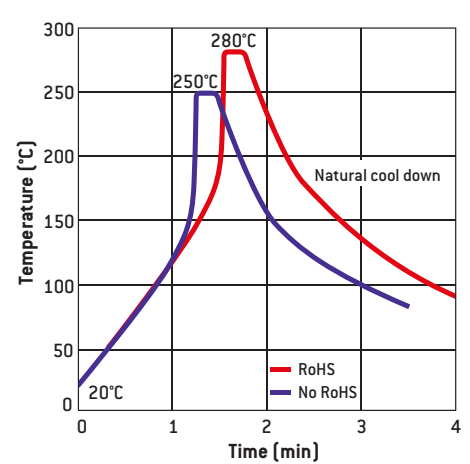

## SOLDERING ADVICES FOR IRON SOLDERING

Attachment with a soldering iron is discouraged due to ceramic brittleness and the process control limitations. In the event that a soldering iron must be used, the following precautions should be observed:

- Use a substrate with chip footprints big enough to allow putting side by side one end of the capacitor and the iron tip without any contact between this tip and the component,
- place the capacitor on this footprint,

- heat the substrate until the capacitor's temperature reaches 150°C minimum (preheating step, maximum 1°C per second),
- place the hot iron tip (a flat tip is preferred) on the footprint **without touching the capacitor**. Use a regulated iron with a 30 watts maximum power. The recommended temperature of the iron is 270 ± 10°C. The temperature gap between the capacitor and the iron tip must not exceed 120°C,

# User Guide

- leave the tip on the footprint for a few seconds in order to increase locally the footprint's temperature,
- use a cored wire solder and put it down on the iron tip. In a preferred way use Sn/Pb/Ag 62/36/2 alloy,
- wait until the solder fillet is formed on the capacitor's termination,
- take away iron and wire solder,

- wait a few minutes so that the substrate and capacitor come back down to the preheating temperature,
- solder the second termination using the same procedure as the first,
- let the soldered component cool down slowly to avoid any thermal shock.

## PACKAGING

### TAPE AND REEL

The films used on the reels correspond to standard IEC 60286-3. Films are delivered on reels in compliance with document IEC 286-3 dated 1991.

Minimum quantity is 250 chips.

Maximum quantities per reel are as follows:

- Super 8 reel - Ø 180: 2,500 chips.
- Super 8 reel - Ø 330: 10,000 chips.
- Super 12 reel - Ø 180: 1,000 chips.

Reel marking complies with CECC 32100 standard:

- Model.
- Rated capacitance.
- Capacitance tolerance.
- Rated voltage.
- Batch number.

### TRAY PACKAGES

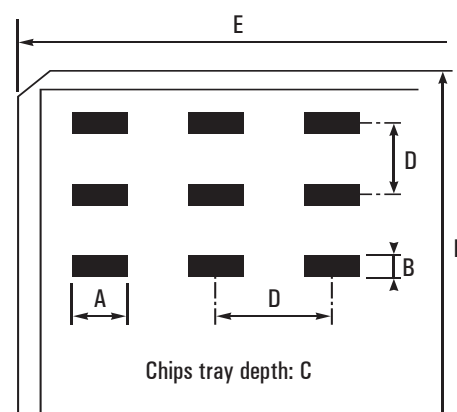

### DIMENSIONAL CHARACTERISTICS OF CHIPS TRAY PACKAGES

Sizes	Nr. of chips/ package	Oriented chips	Dimensions in inches (in mm)				
			A	B	C	D	E
0402	100	No	0 0.112 [0 3.02]		0.065 [1.65]	0.167 [4.24]	2 [50.8]
0403	100	No	0 0.112 [0 3.02]		0.065 [1.65]	0.167 [4.24]	2 [50.8]
0504	100	Yes	0.059 [1.5]	0.045 [1.14]	0.035 [0.89]	0.167 [4.24]	2 [50.8]
0603	340	Yes	0.1 [2.54]	0.06 [1.52]	0.045 [1.14]	0.167 [4.24]	2 [50.8]
0805	100	Yes	0.1 [2.54]	0.06 [1.52]	0.045 [1.14]	0.167 [4.24]	2 [50.8]
1206	100	No	0.14 [3.56]	0.14 [3.56]	0.06 [1.52]	0.167 [4.24]	2 [50.8]
1210	100	Yes	0.14 [3.56]	0.14 [3.56]	0.06 [1.52]	0.167 [4.24]	2 [50.8]
1812	100	No	0.25 [6.35]	0.25 [6.35]	0.13 [3.3]	0.345 [8.76]	4 [101.6]
	25	Yes	0.24 [6.1]	0.265 [6.73]	0.07 [1.78]	0.345 [8.76]	2 [50.8]
2220	100	Yes	0.25 [6.35]	0.25 [6.35]	0.13 [3.3]	0.345 [8.76]	4 [101.6]
	25	Yes	0.24 [6.1]	0.265 [6.73]	0.07 [1.78]	0.345 [8.76]	2 [50.8]

### HIGH Q CAPACITORS TAPE AND REEL PACKAGING SPECIFICATIONS

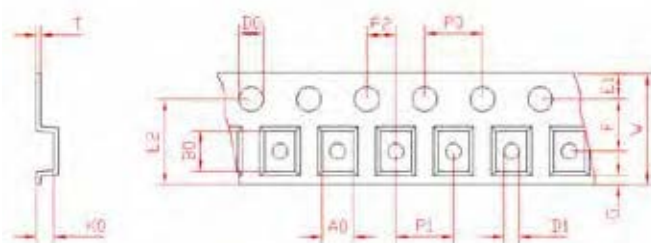

Sizes	Type [1]	W±0.3 inches (mm)	F ±0.05 inches (mm)	P1 ±0.1 inches (mm)	T max. inches (mm)	Reel Size inches (mm)	Quantity per Reel
A [0505]	H	0,315 [8]	0,138 [3.5]	0,157 [4]	0,010 [0,25]	7,087 [180]	3'000
A [0505]	V	0,315 [8]	0,138 [3.5]	0,157 [4]	0,010 [0,25]	7,087 [180]	3'000
S [0603]	H	0,315 [8]	0,138 [3.5]	0,157 [4]	0,016 [0,4]	7,087 [180]	4'000
F [0805]	H	0,315 [8]	0,138 [3.5]	0,157 [4]	0,016 [0,4]	7,087 [180]	4'000
B [1111]	H	0,315 [8]	0,138 [3.5]	0,157 [4]	0,012 [0,3]	7,087 [180]	1'000
B [1111]	V	0,315 [8]	0,138 [3.5]	0,157 [4]	0,010 [0,25]	7,087 [180]	1'000
X [2225]	H	0,472 [12]	0,138 [5.5]	0,472 [12]	0,018 [0,45]	12,992 [330]	500
E [4040]	H	0,945 [24]	0,453±0,004 [11,5±0,1]	0,630 [16]	0,018 [0,45]	12,992 [330]	700
E [4040]	V	1,260 [32]	0,559±0,004 [14,2±0,1]	0,945 [24]	0,022 [0,55]	15 [381]	350

[1]: Horizontal (H) or Vertical (V) orientation in cavities.

# User Guide

## EIA STANDARD CAPACITANCE VALUES

Following EIA standard, the values and multiples that are indicated in the chart below can be ordered. E48, E96 series and intermediary values are available upon request.

E6 (± 20%)	E12 (± 10%)	E24 (± 5%)
10	10	10
		11
		12
15	12	13
		15
		16
22	15	18
		20
		22
33	18	24
		27
		30
47	22	33
		36
		39
68	33	43
		47
		51
82	39	56
		62
		68
100	47	75
		82
		91

## EIA CAPACITANCE CODE

The capacitance is expressed in three digit codes and in units of pico Farads (pF). The first and second digits are significant figures of the capacitance value and the third digit identifies the multiplier.

For capacitance value < 10pF, R designates a decimal point.  
See examples below:

EIA code	Capacitance value		
	in pF	in nF	in $\mu$ F
2R2	2.2	0.0022	0.0000022
6R8	6.8	0.0068	0.0000068
220	22	0.022	0.000022
470	47	0.047	0.000047
181	180	0.18	0.00018
221	220	0.22	0.00022
102	1,000	1	0.001
272	2,700	2.7	0.0027
123	12,000	12	0.012
683	68,000	68	0.068
124	120,000	120	0.12
564	560,000	560	0.56
335	3,300,000	3,300	3.3
825	8,200,000	8,200	8.2
156	15,000,000	15,000	15
686	68,000,000	68,000	68
107	100,000,000	100,000	100
227	220,000,000	220,000	220

## PART MARKING VOLTAGE CODES

Use the following voltage code chart for part markings:

Voltage (V)	Code	Letter code
25	250	A
40	400	B
50	500	C
63	630	D
100	101	E
200	201	G
250	251	H
400	401	K
500	501	L
1,000	102	M
2,000	202	P
3,000	302	R
4,000	402	S
5,000	502	T
7,500	752	U
10,000	103	W

## PART MARKING TOLERANCE CODES

Use the following tolerance code chart for part markings:

Tolerance	Letter code
± 0.25pF	CU
± 0.5pF	DU
± 1pF	FU
± 1%	F
± 2%	G
± 5%	J
± 10%	K
± 20%	M

# User Guide

## RELIABILITY LEVELS

Exxelia proposes different reliability levels for the ceramic capacitors for both NPO and X7R ceramics.

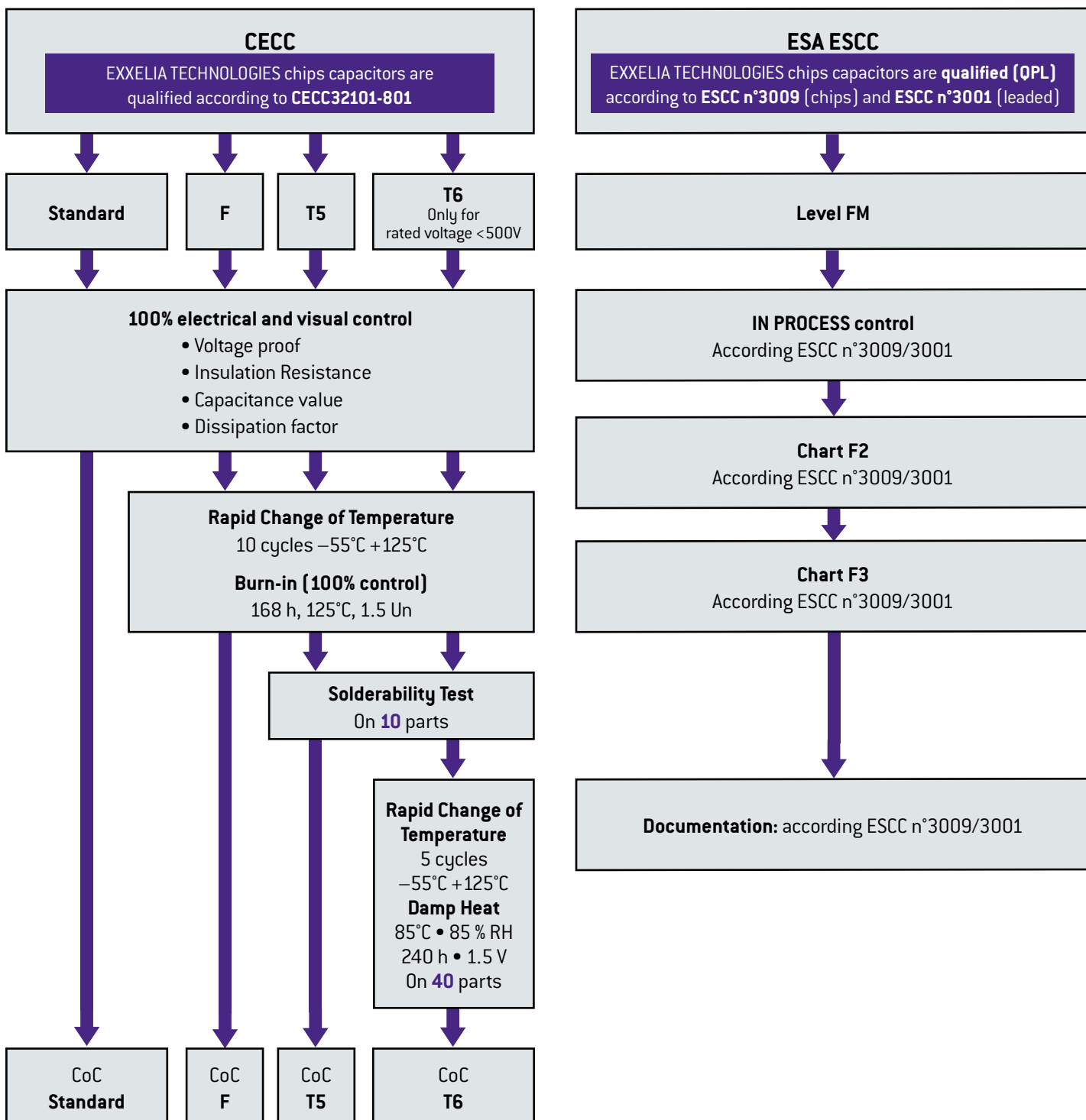

As the world's leading manufacturer of specific passive components, we stand apart through our ability to quickly evaluate the application specific engineering challenges and provide a cost-effective and efficient solutions.

For requirements that cannot be met by catalog products, we offer leading edge solutions in custom configuration: custom geometries, packaging, characteristics, all is possible thanks to our extensive experience and robust development process, while maintaining the highest level of reliability.

Where necessary, special testing is done to verify requirements, such as low dielectric absorption, ultra-high insulation resistance, low dissipation factor, stability under temperature cycling or under specified environmental conditions, etc.

**HIGH CAPACITANCE**

- High energy density
- Specific case sizes
- Specific shape of connections (high resistance to vibrations)



**HIGH VOLTAGE**

- Up to 50 kV
- Specific circular shape

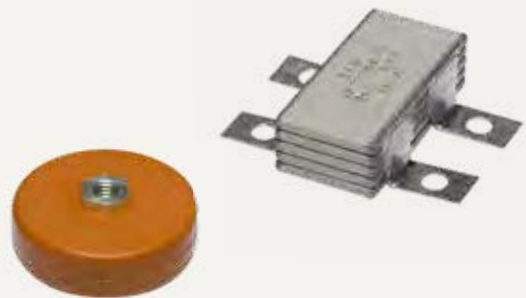

**HIGH TEMPERATURE**

- Up to 250°C
- Specific shape of connections
- 2,000 hours life time
- HMP soldering

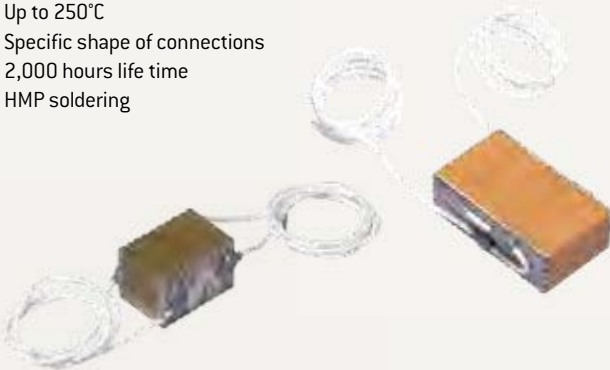



**OTHERS**

- Screen printed resistors
- Complex components
- Full functions available







## Looking for pricing, stock, or lifecycle information?

Click below to explore more details on WIN SOURCE:

-  [View 251SHS3R3BSE on WIN SOURCE](#)
-  [EXXELIA Temex Information](#)

## Optimize Your Supply Chain with WIN SOURCE Solutions

-  Global Sourcing Solution
-  Obsolete Management
-  Cost Control Management
-  Shortage Management
-  Alternative Solution
-  Excess Inventory Management