

CMPD914

**SURFACE MOUNT SILICON
HIGH SPEED
SWITCHING DIODE**



SOT-23 CASE



www.centrasemi.com

DESCRIPTION:

The CENTRAL SEMICONDUCTOR CMPD914 is a ultra-high speed silicon switching diode manufactured by the epitaxial planar process, in an epoxy molded surface mount package, designed for high speed switching applications.

MARKING CODE: C5D

MAXIMUM RATINGS: ($T_A=25^{\circ}\text{C}$)

Continuous Reverse Voltage
Peak Repetitive Reverse Voltage
Continuous Forward Current
Peak Repetitive Forward Current
Peak Forward Surge Current, $t_p=1.0\mu\text{s}$
Peak Forward Surge Current, $t_p=1.0\text{ms}$
Peak Forward Surge Current, $t_p=1.0\text{s}$
Power Dissipation
Operating and Storage Junction Temperature
Thermal Resistance

SYMBOL

V_R 75
 V_{RRM} 100
 I_F 250
 I_{FRM} 250
 I_{FSM} 4.0
 I_{FSM} 2.0
 I_{FSM} 1.0
 P_D 350
 T_J, T_{stg} -65 to +150
 θ_{JA} 357

UNITS

V
V
mA
mA
A
A
A
mW
 $^{\circ}\text{C}$
 $^{\circ}\text{C/W}$

ELECTRICAL CHARACTERISTICS: ($T_A=25^{\circ}\text{C}$ unless otherwise noted)

SYMBOL	TEST CONDITIONS	MIN	MAX	UNITS
I_R	$V_R=20\text{V}$		25	nA
I_R	$V_R=75\text{V}$		5.0	μA
BV_R	$I_R=100\mu\text{A}$	100		V
V_F	$I_F=10\text{mA}$		1.0	V
C_J	$V_R=0, f=1.0\text{MHz}$		4.0	pF
t_{rr}	$I_R=I_F=10\text{mA}, I_{rr}=1.0\text{mA}, R_L=100\Omega$		4.0	ns

CMPD914
**SURFACE MOUNT SILICON
HIGH SPEED
SWITCHING DIODE**



SOT-23 CASE - MECHANICAL OUTLINE

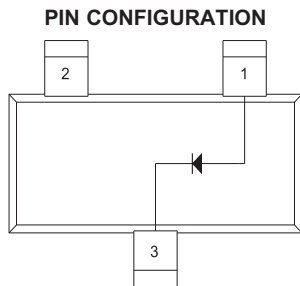
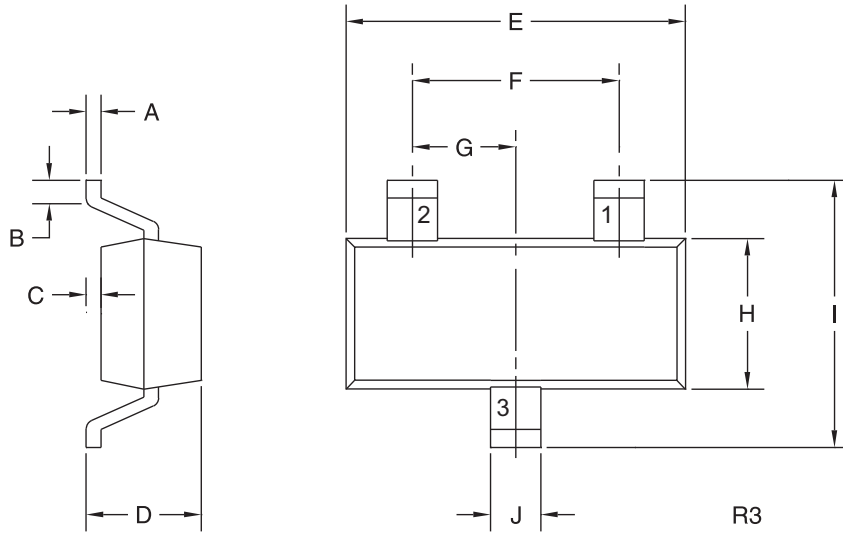

LEAD CODE:
1) Anode
2) No Connection
3) Cathode

MARKING CODE: C5D

DIMENSIONS				
SYMBOL	INCHES		MILLIMETERS	
	MIN	MAX	MIN	MAX
A	0.003	0.007	0.08	0.18
B	0.006	-	0.15	-
C	-	0.005	-	0.13
D	0.035	0.043	0.89	1.09
E	0.110	0.120	2.80	3.05
F	0.075		1.90	
G	0.037		0.95	
H	0.047	0.055	1.19	1.40
I	0.083	0.098	2.10	2.49
J	0.014	0.020	0.35	0.50

SOT-23 (REV: R3)

R7 (12-January 2016)

CMPD914

SURFACE MOUNT SILICON
HIGH SPEED
SWITCHING DIODE



TYPICAL ELECTRICAL CHARACTERISTICS

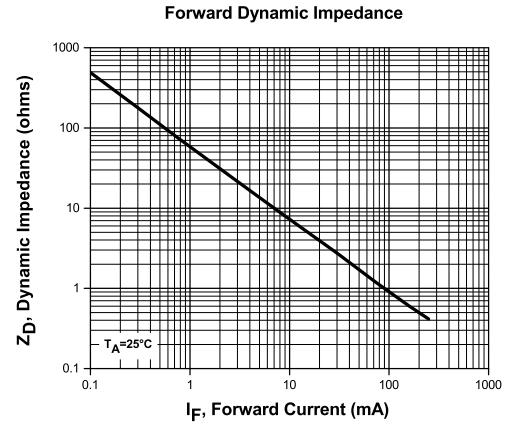
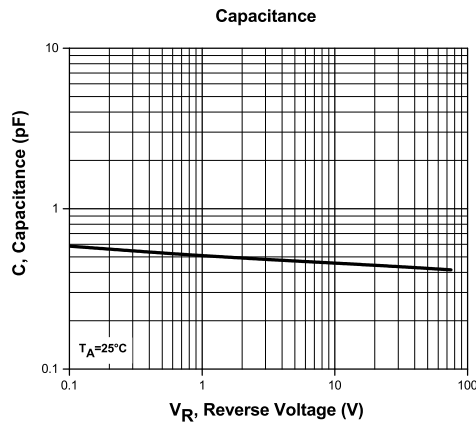
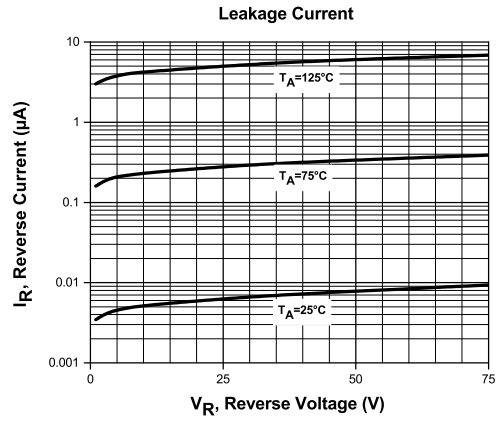
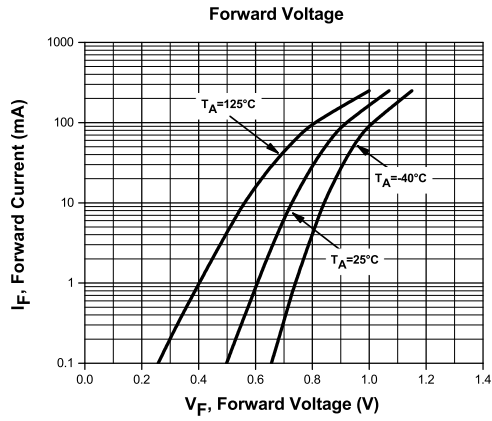

R7 (12-January 2016)

CMPD914

SURFACE MOUNT SILICON
HIGH SPEED
SWITCHING DIODE



TYPICAL ELECTRICAL CHARACTERISTICS

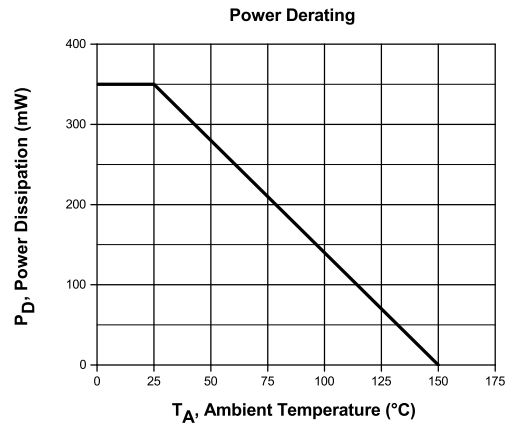
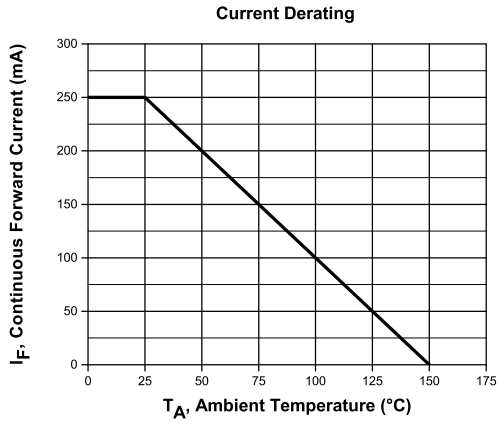

R7 (12-January 2016)

OUTSTANDING SUPPORT AND SUPERIOR SERVICES



PRODUCT SUPPORT

Central's operations team provides the highest level of support to insure product is delivered on-time.

- Supply management (Customer portals)
- Inventory bonding
- Consolidated shipping options
- Custom bar coding for shipments
- Custom product packing

DESIGNER SUPPORT/SERVICES

Central's applications engineering team is ready to discuss your design challenges. Just ask.

- Free quick ship samples (2nd day air)
- Online technical data and parametric search
- SPICE models
- Custom electrical curves
- Environmental regulation compliance
- Customer specific screening
- Up-screening capabilities
- Special wafer diffusions
- PbSn plating options
- Package details
- Application notes
- Application and design sample kits
- Custom product and package development

REQUESTING PRODUCT PLATING

1. If requesting Tin/Lead plated devices, add the suffix " TIN/LEAD" to the part number when ordering (example: 2N2222A TIN/LEAD).
2. If requesting Lead (Pb) Free plated devices, add the suffix " PBFREE" to the part number when ordering (example: 2N2222A PBFREE).

CONTACT US

Corporate Headquarters & Customer Support Team

Central Semiconductor Corp.
145 Adams Avenue
Hauppauge, NY 11788 USA
Main Tel: (631) 435-1110
Main Fax: (631) 435-1824
Support Team Fax: (631) 435-3388
www.centrasemi.com

Worldwide Field Representatives:
www.centrasemi.com/wwreps

Worldwide Distributors:
www.centrasemi.com/wwdistributors

For the latest version of Central Semiconductor's **LIMITATIONS AND DAMAGES DISCLAIMER**, which is part of Central's Standard Terms and Conditions of sale, visit: www.centrasemi.com/terms

Looking for pricing, stock, or lifecycle information?

Click below to explore more details on WIN SOURCE:

- [⊖ View **CMPD914 TR** on WIN SOURCE](#)
- [⊖ **Central Semiconductor Corp** Information](#)

Optimize Your Supply Chain with WIN SOURCE Solutions

- ✓ Global Sourcing Solution
- ✓ Obsolete Management
- ✓ Cost Control Management
- ✓ Shortage Management
- ✓ Alternative Solution
- ✓ Excess Inventory Management