



THE DATASHEET OF CMPSH-3A TR



CMPH-3
CMPH-3A
CMPH-3C
CMPH-3S

**SURFACE MOUNT SILICON
SCHOTTKY DIODES**



www.centrasemi.com

DESCRIPTION:

The CENTRAL SEMICONDUCTOR CMPH-3 series devices are silicon Schottky diodes designed for surface mount fast switching applications requiring a low forward voltage drop.



SOT-23 CASE

The following configurations are available:

CMPH-3 SINGLE
CMPH-3A DUAL, COMMON ANODE
CMPH-3C DUAL, COMMON CATHODE
CMPH-3S DUAL, IN SERIES

MARKING CODE: D95
MARKING CODE: DB1
MARKING CODE: DB2
MARKING CODE: DA5

MAXIMUM RATINGS: (T _A =25°C)	SYMBOL		UNITS
Peak Repetitive Reverse Voltage	V _{RRM}	30	V
Continuous Forward Current	I _F	100	mA
Peak Repetitive Forward Current	I _{FRM}	350	mA
Peak Forward Surge Current, tp=10ms	I _{FSM}	750	mA
Power Dissipation	P _D	350	mW
Operating and Storage Junction Temperature	T _J , T _{stg}	-65 to +150	°C
Thermal Resistance	θ _{JA}	357	°C/W

ELECTRICAL CHARACTERISTICS PER DIODE: (T_A=25°C unless otherwise noted)

SYMBOL	TEST CONDITIONS	MIN	TYP	MAX	UNITS
I _R	V _R =25V		90	500	nA
I _R	V _R =25V, T _A =100°C		25	100	μA
BV _R	I _R =100μA	30			V
V _F	I _F =2.0mA		0.29	0.33	V
V _F	I _F =15mA		0.37	0.45	V
V _F	I _F =100mA		0.51	1.00	V
C _J	V _R =0, f=1.0MHz			20	pF
t _{rr}	I _F =I _R =10mA, I _{rr} =1.0mA, R _L =100Ω			5.0	ns

CMP SH-3
CMP SH-3A
CMP SH-3C
CMP SH-3S
SURFACE MOUNT SILICON
SCHOTTKY DIODES



SOT-23 CASE - MECHANICAL OUTLINE

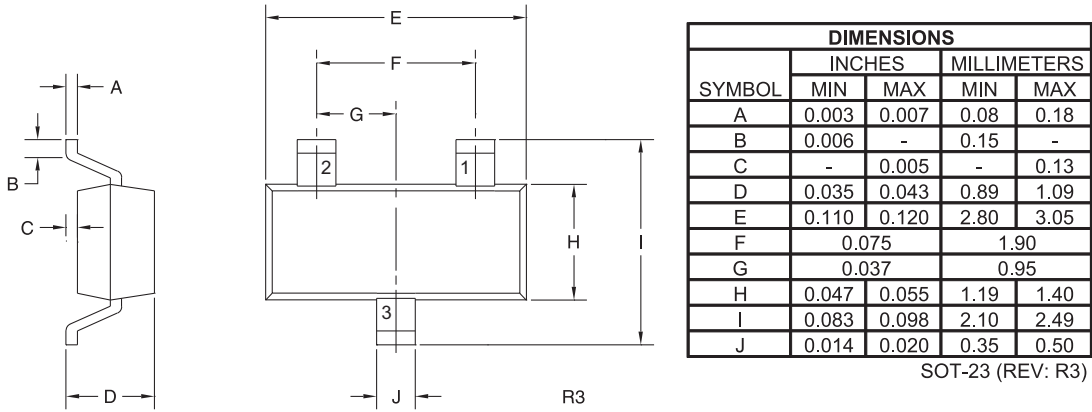

PIN CONFIGURATIONS

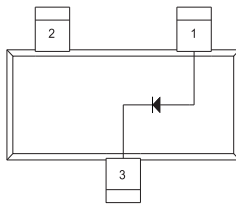

CMP SH-3
LEAD CODE:
 1) Anode
 2) No Connection
 3) Cathode

MARKING CODE: D95

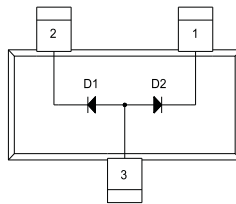

CMP SH-3A
LEAD CODE:
 1) Cathode D2
 2) Cathode D1
 3) Anode D1, D2

MARKING CODE: DB1

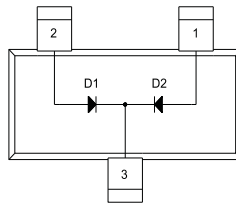

CMP SH-3C
LEAD CODE:
 1) Anode D2
 2) Anode D1
 3) Cathode D1, D2

MARKING CODE: DB2

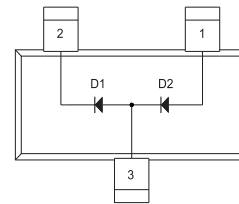

CMP SH-3S
LEAD CODE:
 1) Anode D2
 2) Cathode D1
 3) Anode D1, Cathode D2

MARKING CODE: DA5

R8 (8-September 2016)

CMPH-3
 CMPH-3A
 CMPH-3C
 CMPH-3S

SURFACE MOUNT SILICON
 SCHOTTKY DIODES



TYPICAL ELECTRICAL CHARACTERISTICS

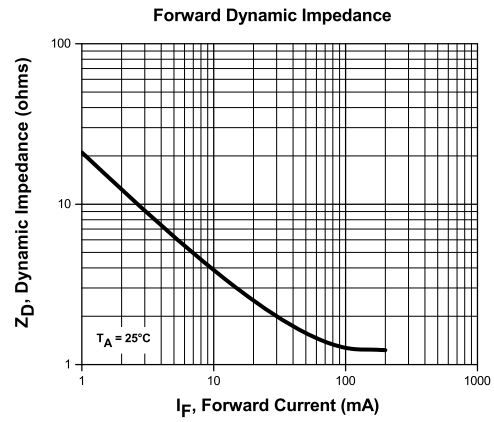
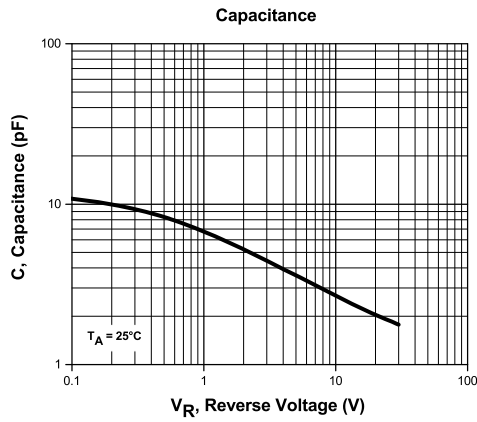
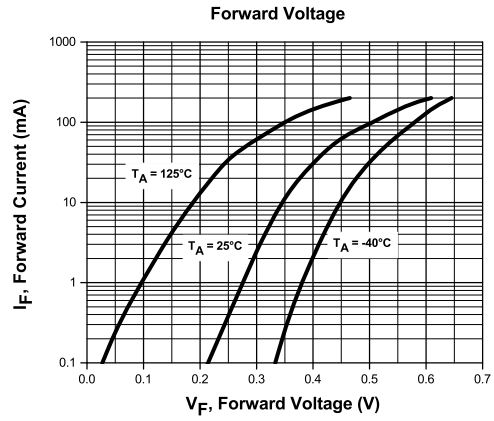
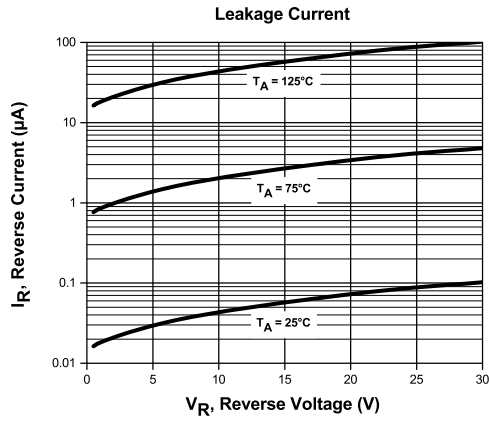

R8 (8-September 2016)

CMP SH-3
 CMP SH-3A
 CMP SH-3C
 CMP SH-3S

SURFACE MOUNT SILICON
 SCHOTTKY DIODES



TYPICAL ELECTRICAL CHARACTERISTICS

Transient Peak Power and Peak Current Capacity

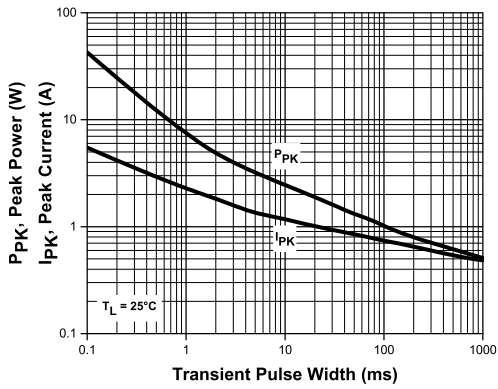

Current Derating

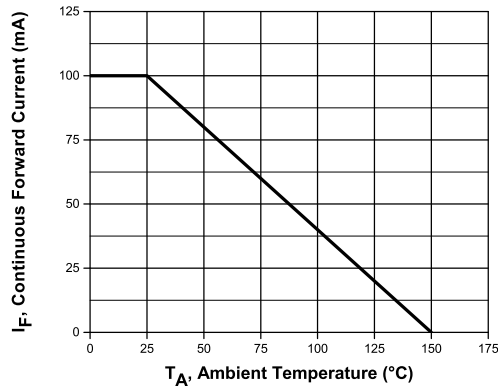

Power Derating

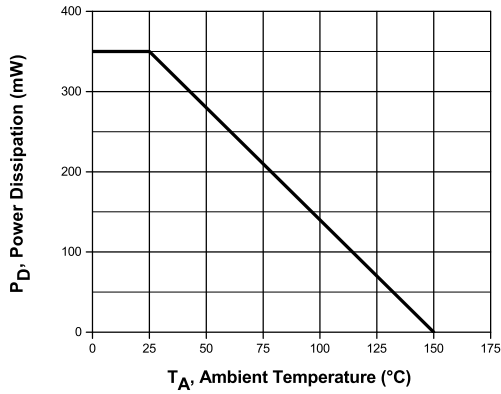

R8 (8-September 2016)

OUTSTANDING SUPPORT AND SUPERIOR SERVICES



PRODUCT SUPPORT

Central's operations team provides the highest level of support to insure product is delivered on-time.

- Supply management (Customer portals)
- Inventory bonding
- Consolidated shipping options
- Custom bar coding for shipments
- Custom product packing

DESIGNER SUPPORT/SERVICES

Central's applications engineering team is ready to discuss your design challenges. Just ask.

- Free quick ship samples (2nd day air)
- Online technical data and parametric search
- SPICE models
- Custom electrical curves
- Environmental regulation compliance
- Customer specific screening
- Up-screening capabilities
- Special wafer diffusions
- PbSn plating options
- Package details
- Application notes
- Application and design sample kits
- Custom product and package development

REQUESTING PRODUCT PLATING

1. If requesting Tin/Lead plated devices, add the suffix " TIN/LEAD" to the part number when ordering (example: 2N2222A TIN/LEAD).
2. If requesting Lead (Pb) Free plated devices, add the suffix " PBFREE" to the part number when ordering (example: 2N2222A PBFREE).

CONTACT US

Corporate Headquarters & Customer Support Team

Central Semiconductor Corp.
145 Adams Avenue
Hauppauge, NY 11788 USA
Main Tel: (631) 435-1110
Main Fax: (631) 435-1824
Support Team Fax: (631) 435-3388
www.centrasemi.com



Worldwide Field Representatives:
www.centrasemi.com/wwreps

Worldwide Distributors:
www.centrasemi.com/wwdistributors

For the latest version of Central Semiconductor's **LIMITATIONS AND DAMAGES DISCLAIMER**, which is part of Central's Standard Terms and Conditions of sale, visit: www.centrasemi.com/terms

Looking for pricing, stock, or lifecycle information?

Click below to explore more details on WIN SOURCE:

-  [View CMPSH-3A TR on WIN SOURCE](#)
-  [Central Semiconductor Corp Information](#)

Optimize Your Supply Chain with WIN SOURCE Solutions

-  Global Sourcing Solution
-  Obsolete Management
-  Cost Control Management
-  Shortage Management
-  Alternative Solution
-  Excess Inventory Management