



**THE DATASHEET OF
SPN02N60C3 E6433**



CoolMOS™ Power Transistor
Features

- New revolutionary high voltage technology
- Ultra low gate charge
- Ultra low effective capacitances
- Extreme dv/dt rated
- Qualified according to JEDEC⁰⁾ for target applications

Product Summary

$V_{DS} @ T_{j,max}$	650	V
$R_{DS(on),max}$	2.5	Ω
I_D	0.4	A

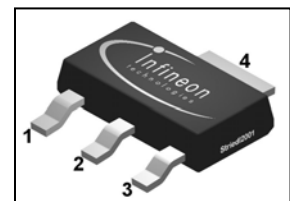
SOT223

Type	Package	Ordering Code	Marking
SPN02N60C3	SOT223	Q67040-S4553	02N60C3

drain pins 2, 4



source pin3

Maximum ratings, at $T_j=25\text{ °C}$, unless otherwise specified

Parameter	Symbol	Conditions	Value	Unit
Continuous drain current	I_D	$T_A=25\text{ °C}$	0.4	A
		$T_A=70\text{ °C}$	0.3	
Pulsed drain current ¹⁾	$I_{D,pulse}$	$T_A=25\text{ °C}$	5.4	
Avalanche energy, single pulse	E_{AS}	$I_D=0.9\text{ A}$, $V_{DD}=50\text{ V}$	50	mJ
Avalanche energy, repetitive t_{AR} ^{1),2)}	E_{AR}	$I_D=1.8\text{ A}$, $V_{DD}=50\text{ V}$	0.07	
Avalanche current, repetitive t_{AR} ¹⁾	I_{AR}		1.8	A
Drain source voltage slope	dv/dt	$I_D=1.8\text{ A}$, $V_{DS}=480\text{ V}$, $T_j=125\text{ °C}$	50	V/ns
Gate source voltage	V_{GS}	static	± 20	V
	V_{GS}	AC ($f > 1\text{ Hz}$)	± 30	
Power dissipation	P_{tot}	$T_A=25\text{ °C}$	1.8	W
Operating and storage temperature	T_j , T_{stg}		-55 ... 150	$^{\circ}\text{C}$

Parameter	Symbol	Conditions	Values			Unit
			min.	typ.	max.	
Thermal characteristics						
Thermal resistance, junction - soldering point	R_{thJS}		-	30	-	K/W
Thermal resistance, junction - ambient	R_{thJA}	SMD version, device on PCB, minimal footprint	-	110	-	K/W
		SMD version, device on PCB, 6 cm ² cooling area ²⁾	-	70	-	
Soldering temperature	T_{sold}	1.6 mm (0.063 in.) from case for 10 s	-	-	260	°C

Electrical characteristics, at $T_j=25\text{ °C}$, unless otherwise specified
Static characteristics

Drain-source breakdown voltage	$V_{(BR)DSS}$	$V_{GS}=0\text{ V}$, $I_D=250\text{ }\mu\text{A}$	600	-	-	V
Avalanche breakdown voltage	$V_{(BR)DS}$	$V_{GS}=0\text{ V}$, $I_D=0.25\text{ A}$	-	700	-	
Gate threshold voltage	$V_{GS(th)}$	$V_{DS}=V_{GS}$, $I_D=0.08\text{ mA}$	2.1	3	3.9	
Zero gate voltage drain current	I_{DSS}	$V_{DS}=600\text{ V}$, $V_{GS}=0\text{ V}$, $T_j=25\text{ °C}$	-	0.5	1	μA
		$V_{DS}=600\text{ V}$, $V_{GS}=0\text{ V}$, $T_j=150\text{ °C}$	-	-	50	
Gate-source leakage current	I_{GSS}	$V_{GS}=20\text{ V}$, $V_{DS}=0\text{ V}$	-	-	100	nA
Drain-source on-state resistance	$R_{DS(on)}$	$V_{GS}=10\text{ V}$, $I_D=1.1\text{ A}$, $T_j=25\text{ °C}$	-	2.0	2.5	Ω
		$V_{GS}=10\text{ V}$, $I_D=1.1\text{ A}$, $T_j=150\text{ °C}$	-	5.2	-	
Gate resistance	R_G	$f=1\text{ MHz}$, open drain	-	9	-	
Transconductance	g_{fs}	$ V_{DS} >2 I_D R_{DS(on)max}$, $I_D=1.1\text{ A}$	-	1.75	-	S

Parameter	Symbol	Conditions	Values			Unit
			min.	typ.	max.	

Dynamic characteristics

Input capacitance	C_{iss}	$V_{GS}=0\text{ V}, V_{DS}=25\text{ V},$ $f=1\text{ MHz}$	-	200	-	pF
Output capacitance	C_{oss}		-	90	-	
Reverse transfer capacitance	C_{rss}		-	4	-	
Effective output capacitance, energy related ³⁾	$C_{o(er)}$	$V_{GS}=0\text{ V}, V_{DS}=0\text{ V}$ to 480 V	-	8	-	
Effective output capacitance, time related ⁴⁾	$C_{o(tr)}$		-	16	-	
Turn-on delay time	$t_{d(on)}$	$V_{DD}=350\text{ V},$ $V_{GS}=10\text{ V}, I_D=1.8\text{ A},$ $R_G=25\ \Omega$	-	6	-	ns
Rise time	t_r		-	3	-	
Turn-off delay time	$t_{d(off)}$		-	68	-	
Fall time	t_f		-	12	30	

Gate Charge Characteristics

Gate to source charge	Q_{gs}	$V_{DD}=420\text{ V}, I_D=1.8\text{ A},$ $V_{GS}=0\text{ to }10\text{ V}$	-	1.6	-	nC
Gate to drain charge	Q_{gd}		-	4	-	
Gate charge total	Q_g		-	10	13	
Gate plateau voltage	$V_{plateau}$		-	5.5	-	V

¹⁾ Pulse width limited by maximum temperature $T_{j,max}$ only

²⁾ Device on 40 mm x 40 mm x 1.5 mm epoxy PCB FR4 with 6 cm² (one layer, 70 μm thick) copper area for drain connection. PCB is vertical in still air.

³⁾ $C_{o(er)}$ is a fixed capacitance that gives the same stored energy as C_{oss} while V_{DS} is rising from 0 to 80% V_{DSS} .

⁴⁾ $C_{o(tr)}$ is a fixed capacitance that gives the same charging time as C_{oss} while V_{DS} is rising from 0 to 80% V_{DSS} .

⁰⁾ J-STD20 and JESD22

Parameter	Symbol	Conditions	Values			Unit
			min.	typ.	max.	

Reverse Diode

Diode continuous forward current	I_S	$T_C=25\text{ }^\circ\text{C}$	-	-	0.4	A
Diode pulse current	$I_{S,pulse}$		-	-	5.4	
Diode forward voltage	V_{SD}	$V_{GS}=0\text{ V}, I_F=0.4\text{ A}, T_J=25\text{ }^\circ\text{C}$	-	0.82	1.05	V
Reverse recovery time	t_{rr}	$V_R=420\text{ V}, I_F=I_S, di_F/dt=100\text{ A}/\mu\text{s}$	-	200	350	ns
Reverse recovery charge	Q_{rr}		-	1.3	-	μC
Peak reverse recovery current	I_{rrm}		-	9	-	A
Peak rate of fall of reverse recovery current	di_{rr}/dt		$T_J=25\text{ }^\circ\text{C}$	-	200	-

Typical Transient Thermal Characteristics

Symbol	Value	Unit	Symbol	Value	Unit
	typ.			typ.	
R_{th1}	0.113	K/W	C_{th1}	0.0000144	Ws/K
R_{th2}	0.156		C_{th2}	0.000087	
R_{th3}	0.875		C_{th3}	0.000123	
R_{th4}	3.63		C_{th4}	0.0005	
R_{th5}	8.29		C_{th5}	0.012	
			C_{th6}	$0.05^{5)}$	

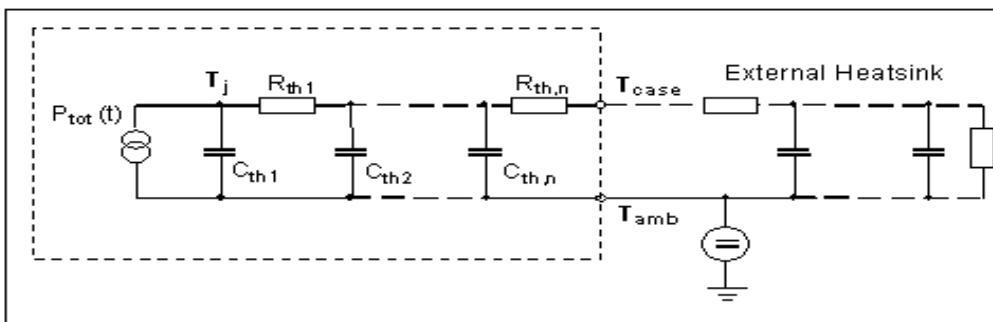

⁵⁾ C_{th6} models the additional heat capacitance of the package in case of non-ideal cooling. It is not needed if $R_{thCA}=0\text{ K/W}$.

1 Power dissipation

$P_{tot}=f(T_C)$

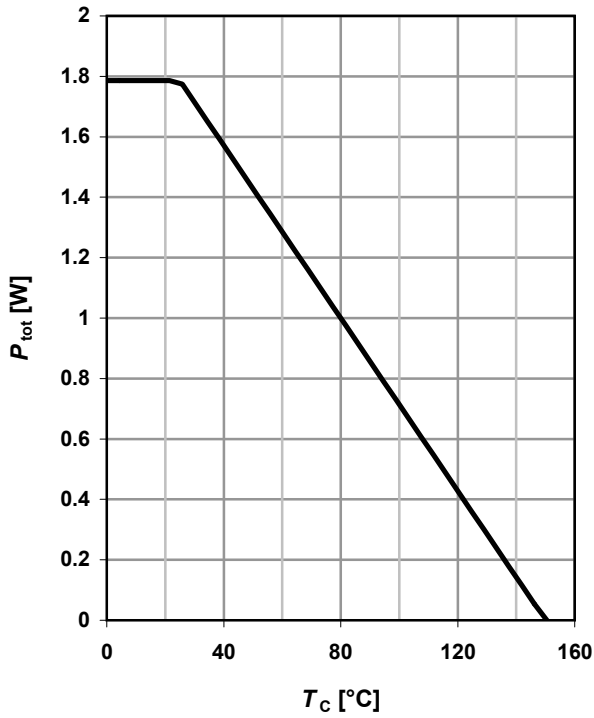

2 Safe operating area

$I_D=f(V_{DS}); T_C=25\text{ °C}; D=0$

parameter: t_p

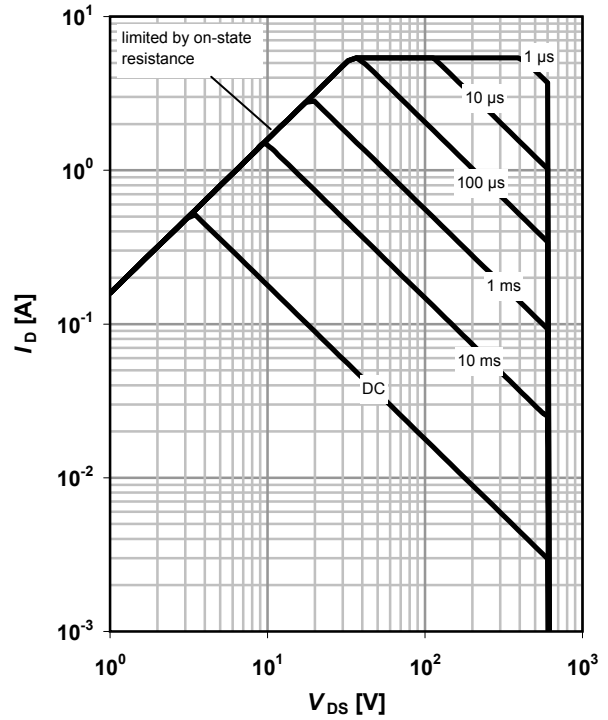

3 Max. transient thermal impedance

$I_D=f(V_{DS}); T_j=25\text{ °C}$

parameter: $D=t_p/T$

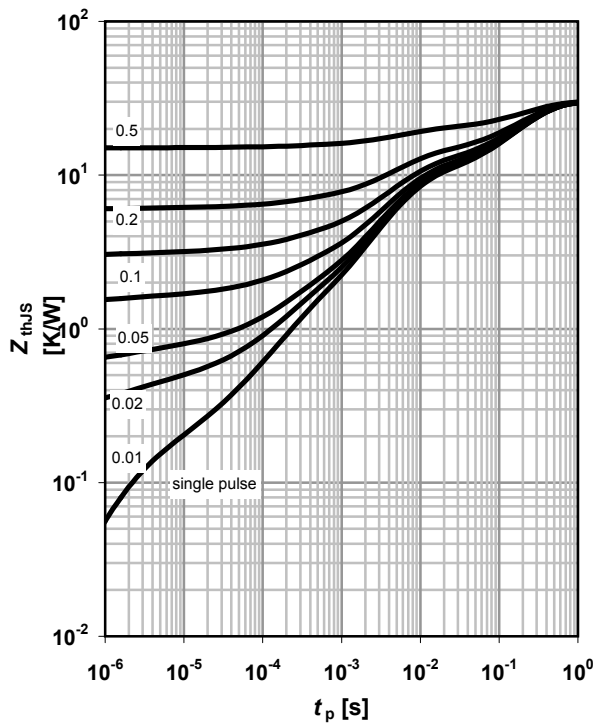

4 Typ. output characteristics

$I_D=f(V_{DS}); T_j=25\text{ °C}$

parameter: V_{GS}

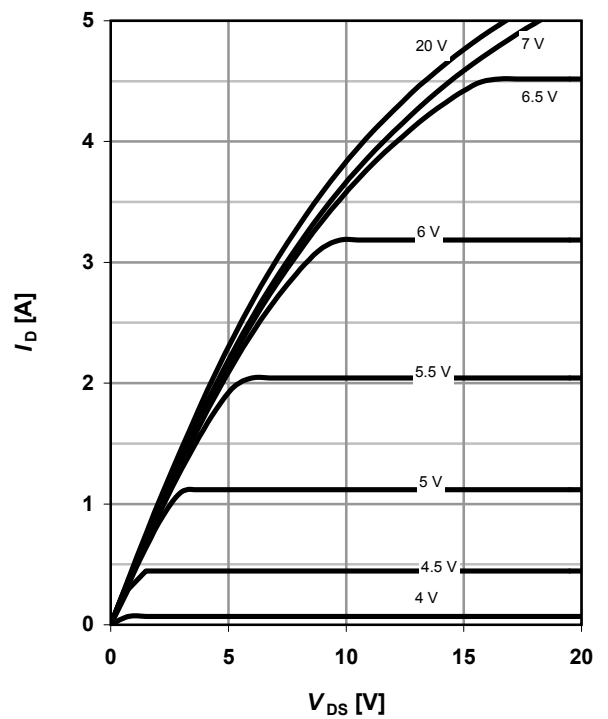

5 Typ. output characteristics

$I_D = f(V_{DS}); T_j = 150\text{ }^\circ\text{C}$

parameter: V_{GS}

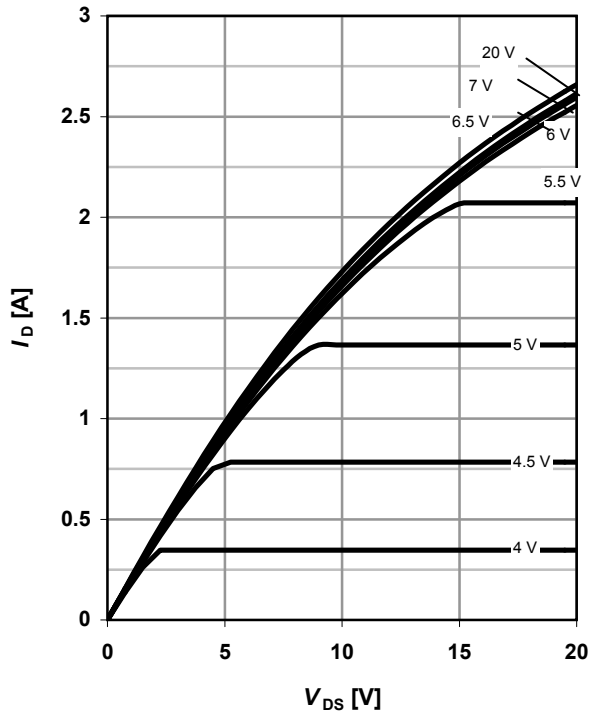

6 Typ. drain-source on-state resistance

$R_{DS(on)} = f(I_D); T_j = 150\text{ }^\circ\text{C}$

parameter: V_{GS}

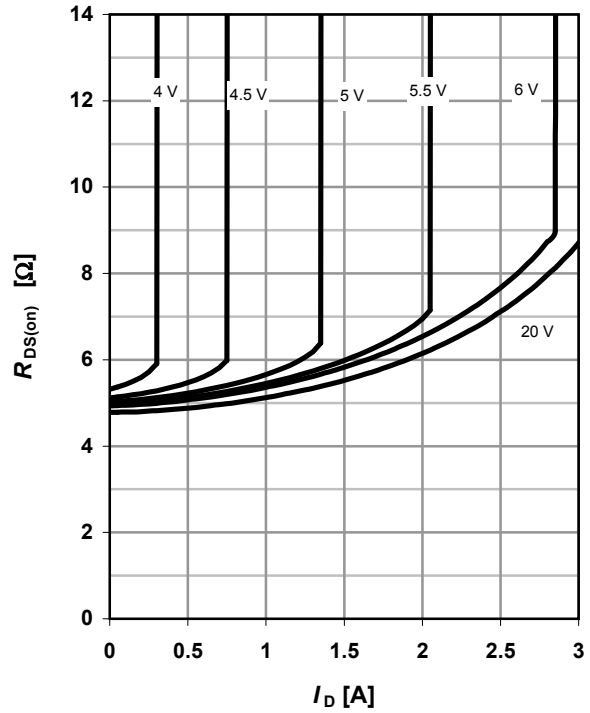

7 Drain-source on-state resistance

$R_{DS(on)} = f(T_j); I_D = 1.1\text{ A}; V_{GS} = 10\text{ V}$

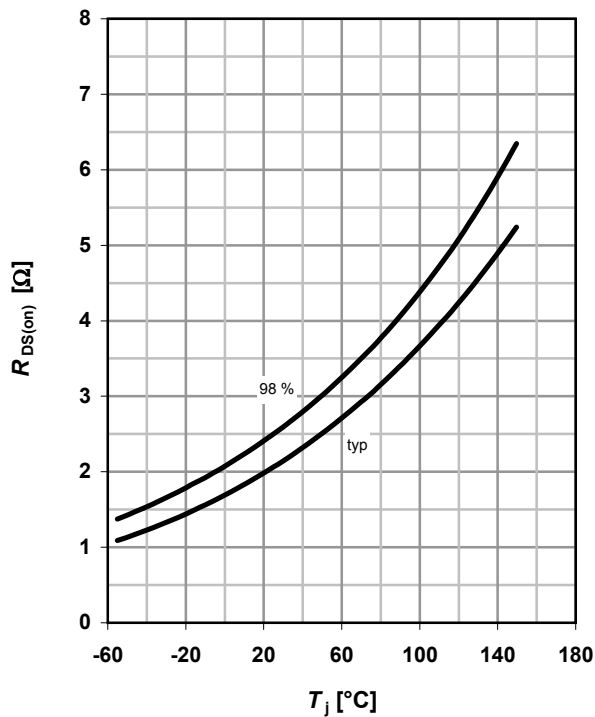

8 Typ. transfer characteristics

$I_D = f(V_{GS}); |V_{DS}| > 2|I_D|R_{DS(on)max}$

parameter: T_j

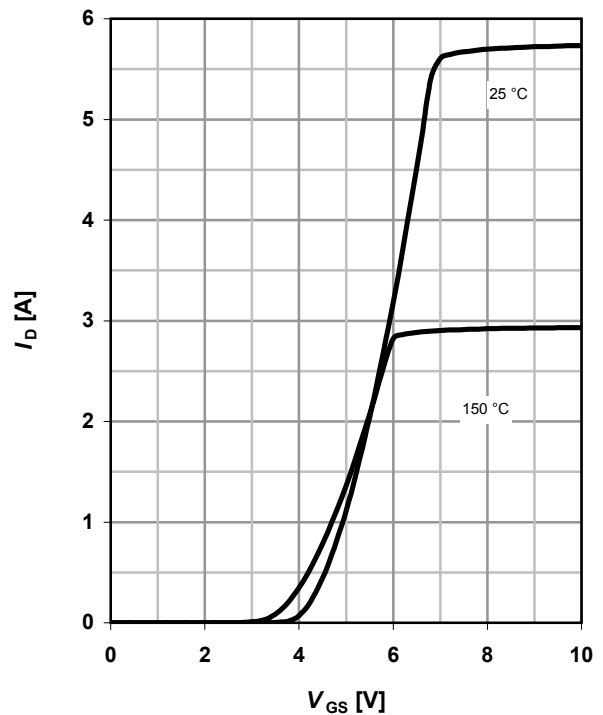

9 Typ. gate charge

$V_{GS}=f(Q_{gate}); I_D=1.8\text{ A pulsed}$

parameter: V_{DD}

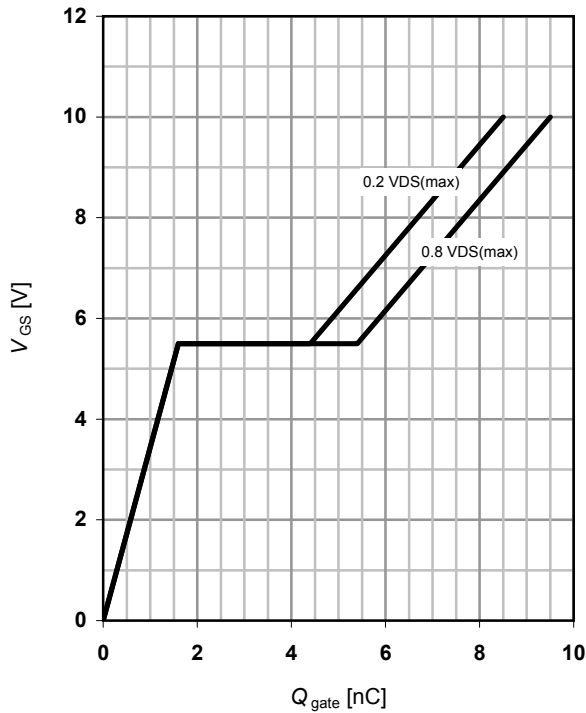

10 Forward characteristics of reverse diode

$I_F=f(V_{SD})$

parameter: T_j

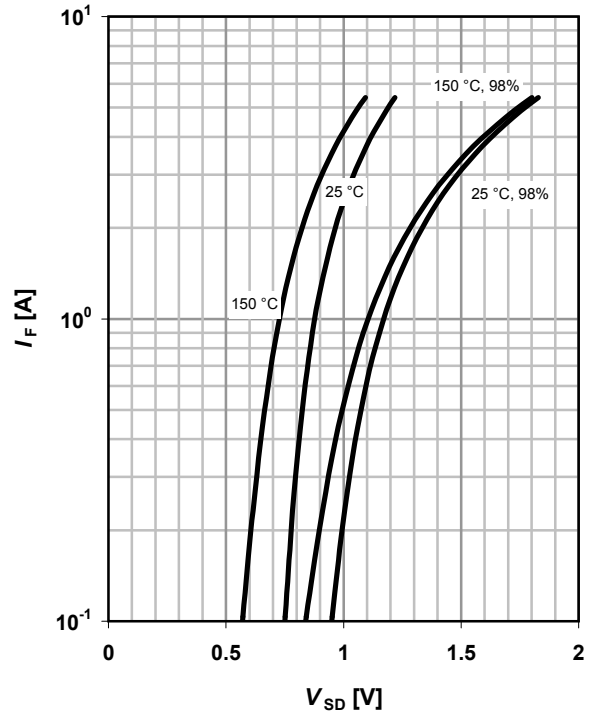

11 Avalanche SOA

$I_{AR}=f(t_{AR})$

parameter: $T_{j(start)}$

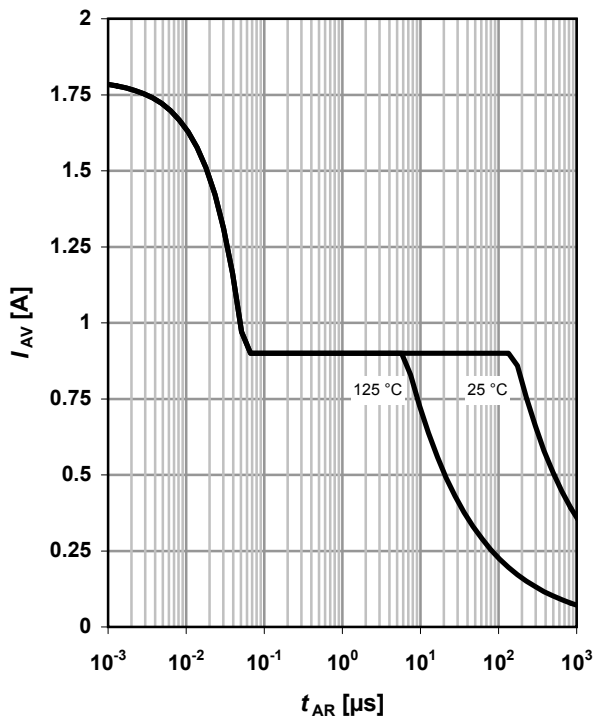

12 Avalanche energy

$E_{AS}=f(T_j); I_D=0.9\text{ A}; V_{DD}=50\text{ V}$

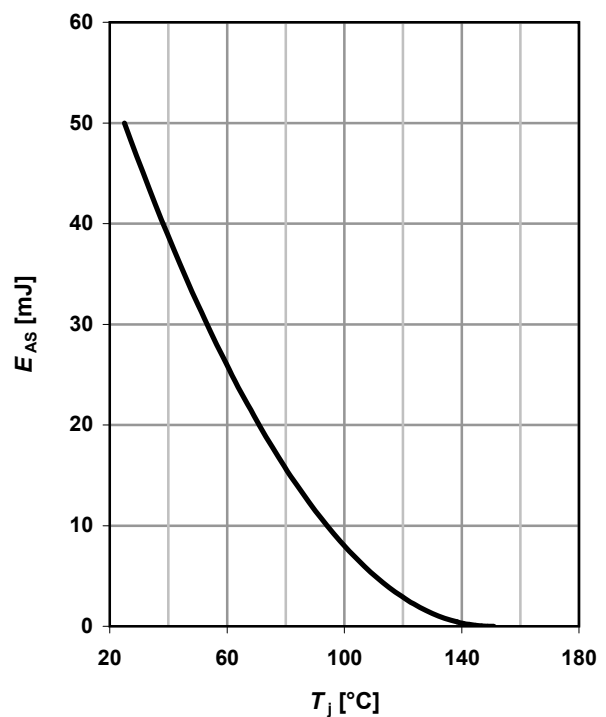

13 Drain-source breakdown voltage

$$V_{BR(DSS)} = f(T_j); I_D = 0.25 \text{ mA}$$

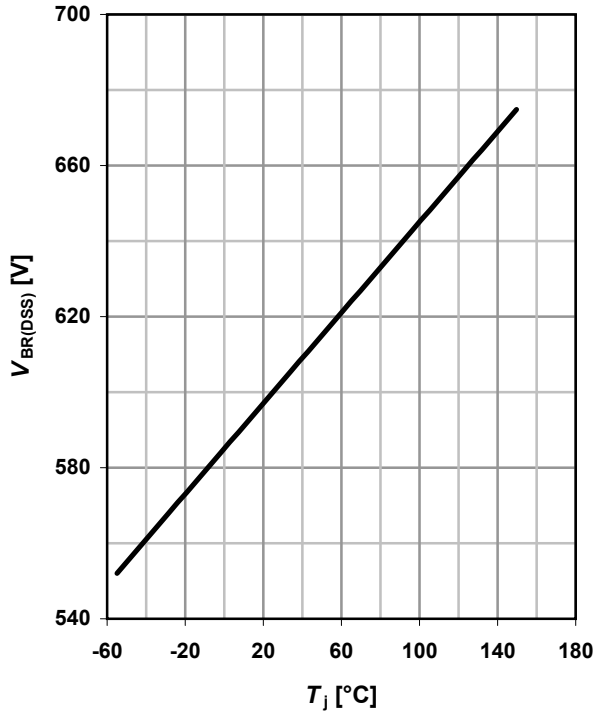

14 Typ. capacitances

$$C = f(V_{DS}); V_{GS} = 0 \text{ V}; f = 1 \text{ MHz}$$

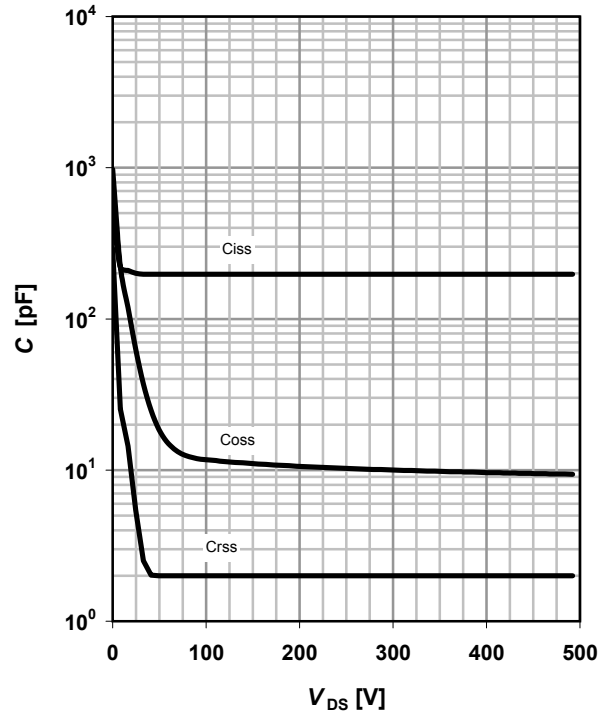

15 Typ. C_{oss} stored energy

$$E_{oss} = f(V_{DS})$$

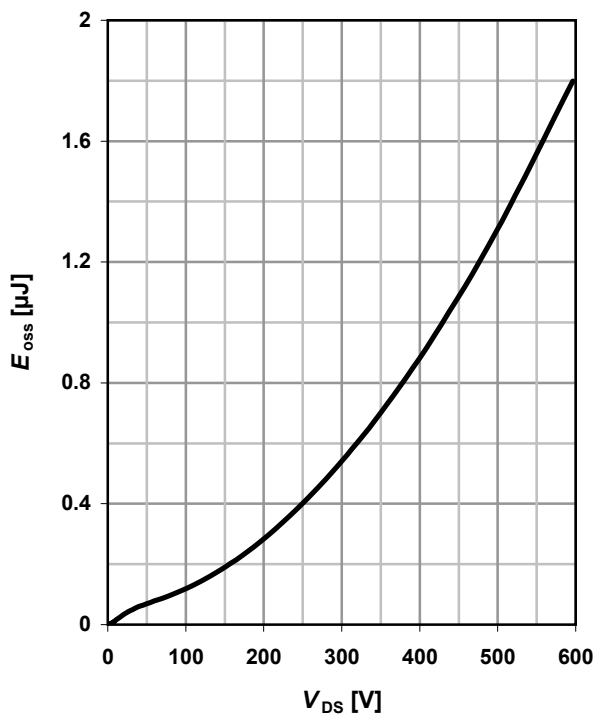

Definition of diode switching characteristics

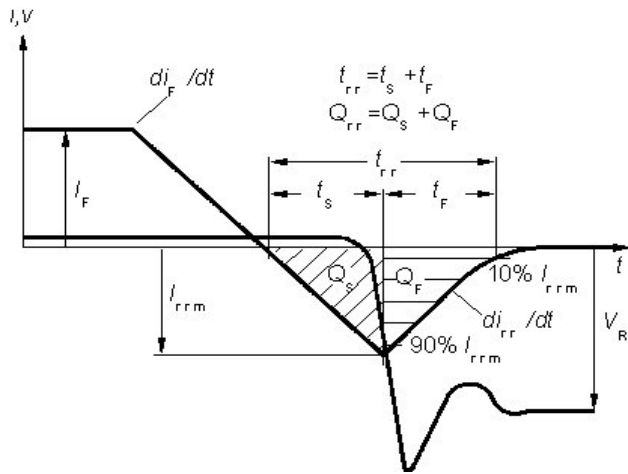

SOT-223

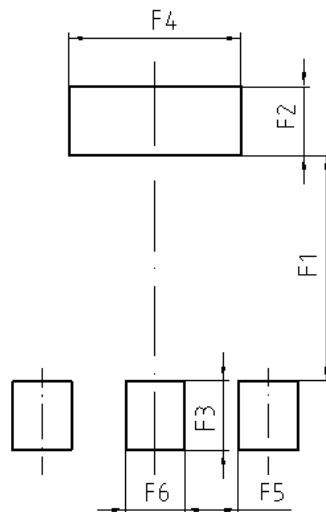
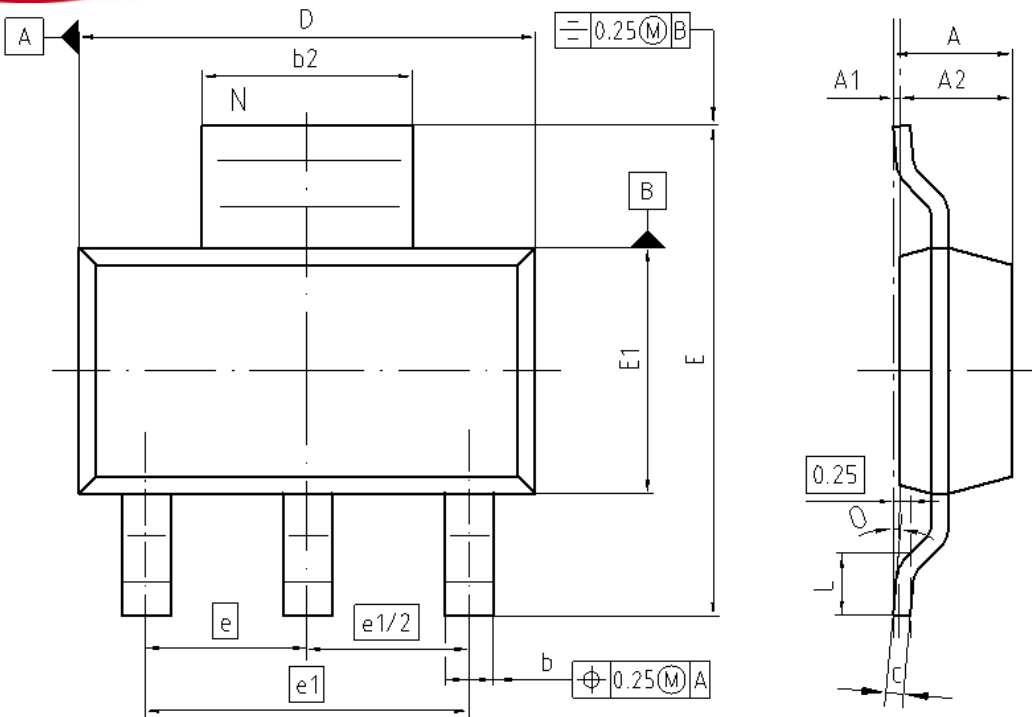

FOOTPRINT (REFLOW SOLDERING)

DIM	MILLIMETERS		INCHES	
	MIN	MAX	MIN	MAX
A	1.6	1.8	0.063	0.071
A1	-	0.1	-	0.004
A2	1.5	1.7	0.059	0.067
b	0.6	0.8	0.024	0.031
b2	2.9	3.1	0.114	0.122
c	0.24	0.32	0.009	0.013
D	6.3	6.7	0.248	0.264
E	6.7	7.3	0.264	0.287
E1	3.3	3.7	0.123	0.146
e	2.3 BASIC		0.091 BASIC	
e1	4.6 BASIC		0.181 BASIC	
L	0.75	-	0.023	-
N	4		4	
O	0°	10°	0°	10°
F1	1.8 BASIC		0.189 BASIC	
F2	1.4 BASIC		0.055 BASIC	
F3	1.4 BASIC		0.055 BASIC	
F4	3.5 BASIC		0.138 BASIC	
F5	1.1 BASIC		0.043 BASIC	
F6	1.2 BASIC		0.047 BASIC	

REFERENCE
JEDEC TO261 AA

SCALE

EUROPEAN PROJECTION

ISSUE DATE
04-28-2006

FILE
SOT223

Published by
Infineon Technologies AG
81726 Munich, Germany

© Infineon Technologies AG 2000
All Rights Reserved.

Attention please!

The information herein is given to describe certain components and shall not be considered as warranted characteristics.

Terms of delivery and rights to technical change reserved.

We hereby disclaim any and all warranties, including but not limited to warranties of non-infringement, regarding circuits, descriptions and charts stated herein.

Infineon Technologies is an approved CECC manufacturer.

Information

For further information on technology, delivery terms and conditions and prices, please contact your nearest Infineon Technologies office in Germany or our Infineon Technologies representatives worldwide (see address list).



Warnings

Due to technical requirements, components may contain dangerous substances.
For information on the types in question, please contact your nearest Infineon Technologies office.

Infineon Technologies' components may only be used in life-support devices or systems with the expressed written approval of Infineon Technologies if a failure of such components can reasonably be expected to cause the failure of that life-support device or system, or to affect the safety or effectiveness of that device or system. Life support devices or systems are intended to be implanted in the human body, or to support and/or maintain and sustain and/or protect human life. If they fail, it is reasonable to assume that the health of the user or other persons may be endangered.

Looking for pricing, stock, or lifecycle information?

Click below to explore more details on WIN SOURCE:

-  [View SPN02N60C3 E6433 on WIN SOURCE](#)
-  [Infineon Technologies Information](#)

Optimize Your Supply Chain with WIN SOURCE Solutions

-  Global Sourcing Solution
-  Obsolete Management
-  Cost Control Management
-  Shortage Management
-  Alternative Solution
-  Excess Inventory Management