



THE DATASHEET OF RT8004GQV



3A, 4MHz, Synchronous Step-Down Regulator

General Description

The RT8004 is a high efficiency synchronous, step-down DC/DC converter. Its input voltage range is from 2.65V to 5.5V and provides an adjustable regulated output voltage from 0.8V to 5V while delivering up to 3A of output current.

The internal power switch with 75mΩ on-resistance increases efficiency and eliminates the need for an external Schottky diode. Switching frequency is set by an external resistor or can be synchronized to an external clock. 100% duty cycle provides low dropout operation extending battery life in portable systems. External compensation allows the transient response to be optimized over a wide range of loads and output capacitors.

The RT8004 operates in Forced Continuous Mode which reduces noise and RF interference. 100% duty cycle in Low Dropout Operation further maximize battery life.

Ordering Information

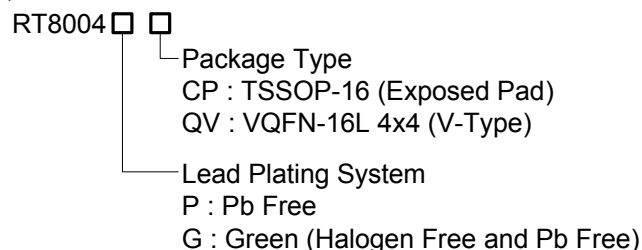

Note :

Richtek products are :

- ▶ RoHS compliant and compatible with the current requirements of IPC/JEDEC J-STD-020.
- ▶ Suitable for use in SnPb or Pb-free soldering processes.

Marking Information

For marking information, contact our sales representative directly or through a Richtek distributor located in your area.

Features

- High Efficiency : Up to 95%
- Low Quiescent Current : 100μA
- Low $R_{DS(ON)}$ Internal Switches : 75mΩ
- Programmable Frequency : 300kHz to 4MHz
- No Schottky Diode Required
- 0.8V Reference Allows Low Output Voltage
- Low Dropout Operation : 100% Duty Cycle
- Synchronizable Switching Frequency
- Power Good Output Voltage Monitor
- Over Temperature Protection
- Thermally Enhanced TSSOP-16 (Exposed Pad) and 16-Lead VQFN 4x4 Packages
- RoHS Compliant and 100% Lead (Pb)-Free

Applications

- Portable Instruments
- Battery-Powered Equipment
- Notebook Computers
- Distributed Power Systems
- IP Phones
- Digital Cameras

Pin Configurations

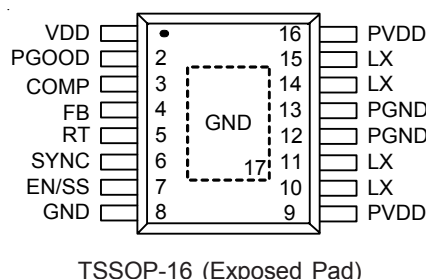
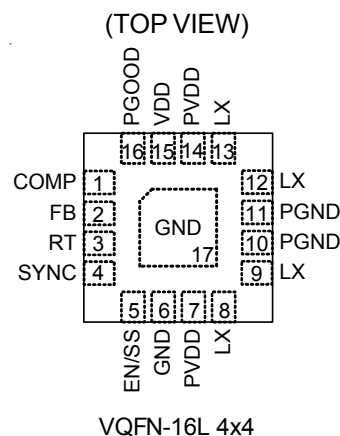

Typical Application Circuit

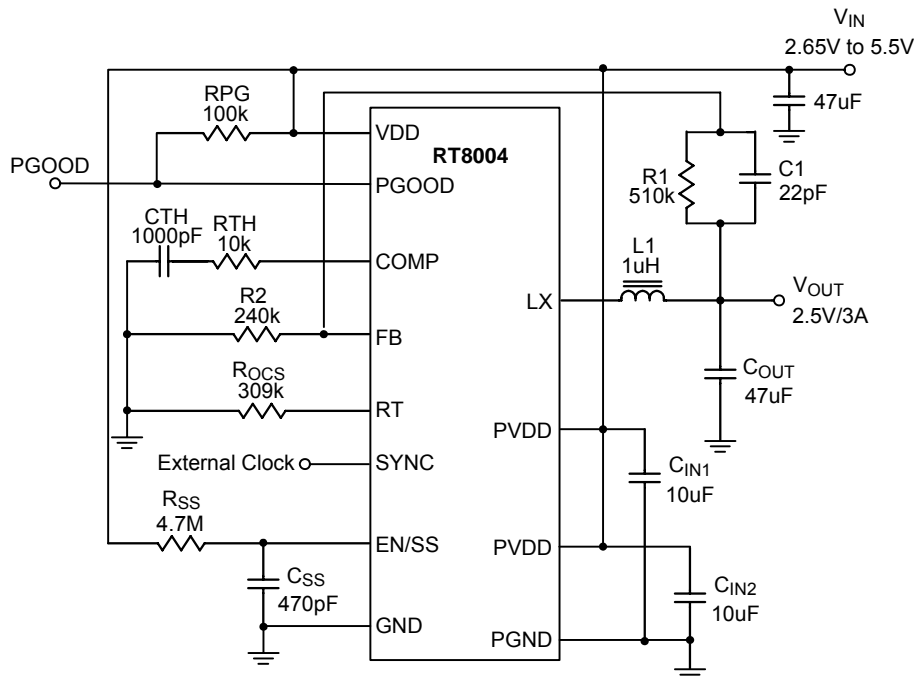

Functional Pin Description

Pin No.		Pin Name	Pin Function
RT8004PCP	RT8004PQP		
1	15	VDD	Signal Input Supply. Decouple this pin to GND with a capacitor. Normally VDD is equal to PVDD.
2	16	PGOOD	Power Good Indicator. Open-drain logic output that is pulled to ground when the output voltage is not within $\pm 12.5\%$ of regulation point.
3	1	COMP	Error Amplifier Compensation Pin. The current comparator threshold increases with this control voltage. Connect external compensation elements to this pin to stabilize the control loop.
4	2	FB	Feedback Pin. Receives the feedback voltage from a resistive divider connected across the output.
5	3	RT	Oscillator Resistor Input. Connecting a resistor to ground from this pin sets the switching frequency.
6	4	SYNC	External Clock Synchronization Input. The internal oscillator can be synchronized to an external clock applied to this pin. If not use, please connect this pin to VDD or GND.
7	5	EN/SS	Enable Control and Soft-Start Input. Forcing this pin below 0.5V shuts down the RT8004. In shutdown all functions are disabled drawing $< 1\mu\text{A}$ of supply current. A capacitor to ground from this pin sets the ramp time to full output current.
8, Exposed Pad (17)	6, Exposed Pad (17)	GND	Signal Ground. All small-signal components, compensation components and the exposed pad on the bottom side of the IC should connect to this ground, which in turn connects to PGND at one point.
9, 16	7, 14	PVDD	Power Input Supply. Decouple this pin to PGND with a capacitor.
10, 11, 14, 15	8, 9, 12, 13	LX	Internal Power MOSFET Switches Output. Connect this pin to the inductor.
12, 13	10, 11	PGND	Power Ground. Connect this pin close to the terminal of C_{IN} and C_{OUT} .

Function Block Diagram

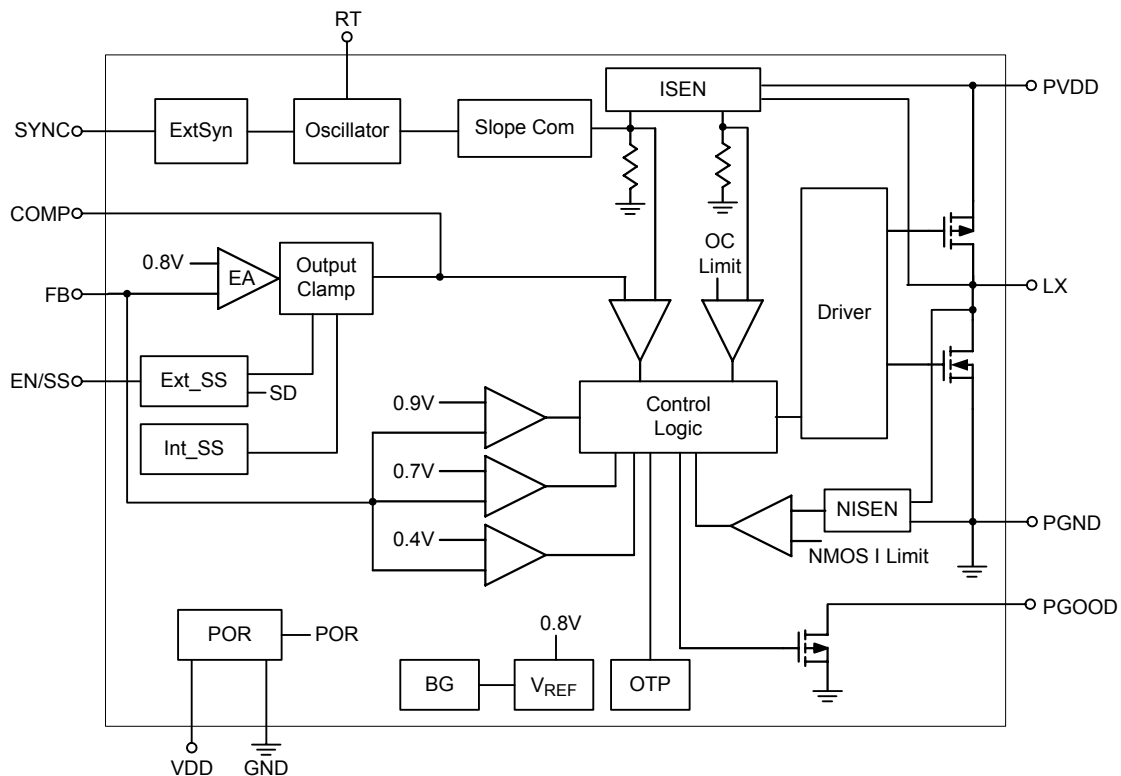

Operation

Main Control Loop

The RT8004 is a monolithic, constant-frequency, current mode step-down DC/DC converter. During normal operation, the internal top power switch (P-MOSFET) is turned on at the beginning of each clock cycle. Current in the inductor increases until the peak inductor current reach the value defined by the voltage on the COMP pin. The error amplifier adjusts the voltage on the COMP pin by comparing the feedback signal from a resistor divider on the FB pin with an internal 0.8V reference. When the load current increases, it causes a reduction in the feedback voltage relative to the reference. The error amplifier raises the COMP voltage until the average inductor current matches the new load current. When the top power MOSFET shuts off, the synchronous power switch (N-MOSFET) turns on until either the bottom current limit is reached or the beginning of the next clock cycle. The bottom current limit is set at $-2A$.

The operating frequency is set by an external resistor connected between the RT pin and ground. The practical switching frequency can range from 300kHz to 4MHz.

Power Good comparators will pull the PGOOD output low if the output voltage comes out of regulation by 12.5%. In an over voltage condition, the top power MOSFET is turned off and the bottom power MOSFET is switched on until either the overvoltage condition clears or the bottom MOSFET's current limit is reached.

Frequency Synchronization

The internal oscillator of the RT8004 can be synchronized to an external clock connected to the SYNC pin. The frequency of the external clock can be in the range of 300kHz to 4MHz. For this application, the oscillator timing resistor should be chosen to correspond to a frequency that is about 20% lower than the synchronization frequency.

Dropout Operation

When the input supply voltage decreases toward the output voltage, the duty cycle increases toward the maximum on-time. Further reduction of the supply voltage forces the main switch to remain on for more than one cycle eventually reaching 100% duty cycle. The output voltage will then be determined by the input voltage minus the voltage drop across the internal P-MOSFET and the inductor.

Low Supply Operation

The RT8004 is designed to operate down to an input supply voltage of 2.65V. One important consideration at low input supply voltages is that the $R_{DS(ON)}$ of the P-MOSFET and N-MOSFET power switches increases. The user should calculate the power dissipation when the RT8004 is used at 100% duty cycle with low input voltages to ensure that thermal limits are not exceeded.

Slope Compensation and Inductor Peak Current

Slope compensation provides stability in constant frequency architectures by preventing subharmonic oscillations at duty cycles greater than 50%. It is accomplished internally by adding a compensating ramp to the inductor current signal. Normally, the maximum inductor peak current is reduced when slope compensation is added. In the RT8004, however, separated inductor current signals are used to monitor over current condition and minimum peak current. This keeps the maximum output current and minimum peak current relatively constant regardless of duty cycle.

Short Circuit Protection

When the output is shorted to ground, the inductor current decays very slowly during a single switching cycle. A current runaway detector is used to monitor inductor current. As current increasing beyond the control of current loop, switching cycles will be skipped to prevent current runaway from occurring.

Absolute Maximum Ratings (Note 1)

- Supply Input Voltage ----- -0.3V to 6V
- LX Pin Switch Voltage ----- -0.3V to (PV_{DD} + 0.3V)
- Other I/O Pin Voltages ----- -0.3V to (V_{DD} + 0.3V)
- Power Dissipation, P_D @ T_A = 25°C
 - TSSOP-16 ----- 2.66W
 - VQFN-16L 4x4 ----- 2.315W
- Package Thermal Resistance (Note 2)
 - TSSOP-16, θ_{JA} ----- 47°C/W
 - VQFN-16L 4x4, θ_{JA} ----- 54°C/W
 - VQFN-16L 4x4, θ_{JC} ----- 7°C/W
- Lead Temperature (Soldering, 10 sec.) ----- 260°C
- Junction Temperature ----- 150°C
- Storage Temperature Range ----- -65°C to +150°C
- ESD Susceptibility (Note 3)
 - HBM (Human Body Mode) ----- 2kV
 - MM (Machine Mode) ----- 200V

Recommended Operating Conditions (Note 4)

- Supply Input Voltage ----- 2.65V to 5.5V
- Ambient Temperature Range ----- -40°C to 85°C
- Junction Temperature Range ----- -40°C to 125°C

Electrical Characteristics

(V_{DD} = 3.3V, T_A = 25°C, unless otherwise specified)

Parameter	Symbol	Test Conditions	Min	Typ	Max	Unit
Input Voltage Range	V _{DD}		2.65	--	5.5	V
Feedback Voltage	V _{FB}	(Note 5)	0.784	0.8	0.816	V
Feedback Leakage Current	I _{FB}		--	--	0.4	μA
Input DC Bias Current		Active, V _{FB} = 0.78V, Not switching	180	400	520	μA
		Shutdown, V _{EN} < 0.1V (Note 5)	--	--	1	μA
Reference Voltage Line Regulation		V _{IN} = 2.7V to 5.5V (Note 5)	--	0.04	0.5	%/V
Output Voltage Load Regulation		Measured in Servo Loop, V _{COMP} = 1.2V to 1.6V (Note 5)	--	0.05	+/-0.2	%
Power Good						
Power Good Range			--	±12.5	±15	%
Power Good Pull-Down Resistance			--	--	120	Ω
Switching Frequency	f _{osc}	R _{osc} = 309k	0.8	1	1.2	MHz
		Switching Frequency Range	0.3	--	4	MHz
Sync Frequency Range		(Note 6)	0.3	--	4	MHz

To be continued

Parameter	Symbol	Test Conditions	Min	Typ	Max	Unit
Switch On Resistance, High	R _{PFET}	I _{SW} = 1A	45	75	110	mΩ
Switch On Resistance, Low	R _{NFET}	I _{SW} = 1A	45	69	100	mΩ
Peak Current Limit	I _{LIM}		4	5.2	–	A
Under Voltage Lockout Threshold		VDD Rising	2.25	2.52	2.7	V
		Hysteresis	–	0.15	–	V
SW Leakage Current		V _{EN} = 0V, V _{IN} = 5.5V	–	–	1	μA
EN/SS Leakage Current			–	–	1	μA
Enable Threshold	V _{EN}		0.65	–	0.95	V

Note 1. Stresses listed as the above “Absolute Maximum Ratings” may cause permanent damage to the device. These are for stress ratings. Functional operation of the device at these or any other conditions beyond those indicated in the operational sections of the specifications is not implied. Exposure to absolute maximum rating conditions for extended periods may remain possibility to affect device reliability.

Note 2. θ_{JA} is measured in the natural convection at $T_A = 25^\circ\text{C}$ on 4-layers high effective thermal conductivity test board of JEDEC 51-7 thermal measurement standard. The measurement case position of θ_{JC} is on the exposed pad of the package.

Note 3. Devices are ESD sensitive. Handling precaution recommended.

Note 4. The device is not guaranteed to function outside its operating conditions.

Note 5. The specifications over the -40°C to 85°C operation ambient temperature range are assured by design, characterization and correlation with statistical process controls.

Note 6. The external synchronous frequency must be equal to 1 to 1.3 times of the internal setting frequency. The switching frequency range is guaranteed by design but not production tested.

Typical Operating Characteristics

Efficiency vs. Output Current

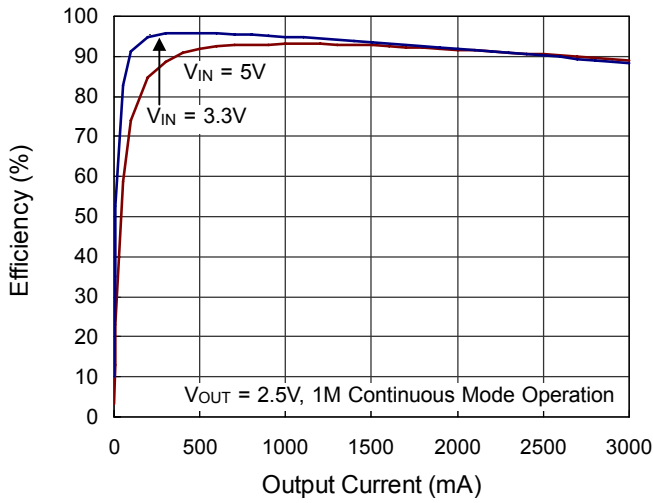

Load Regulation

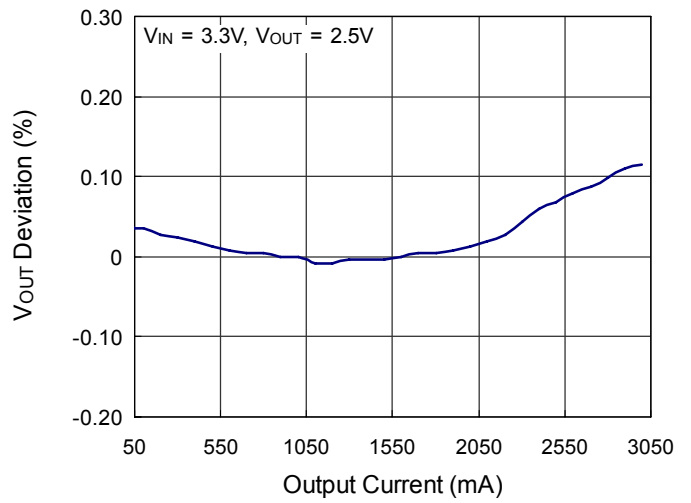

Soft-Start Power On

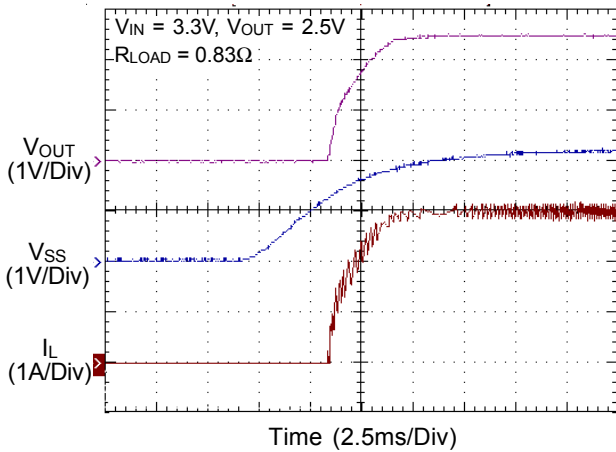

Power Off

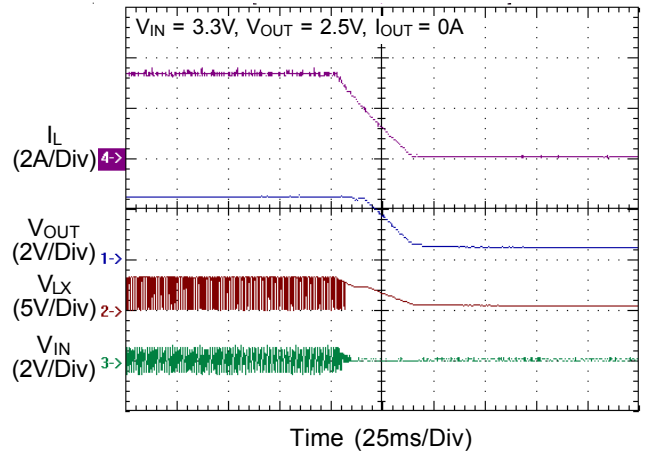

Ripple Voltage

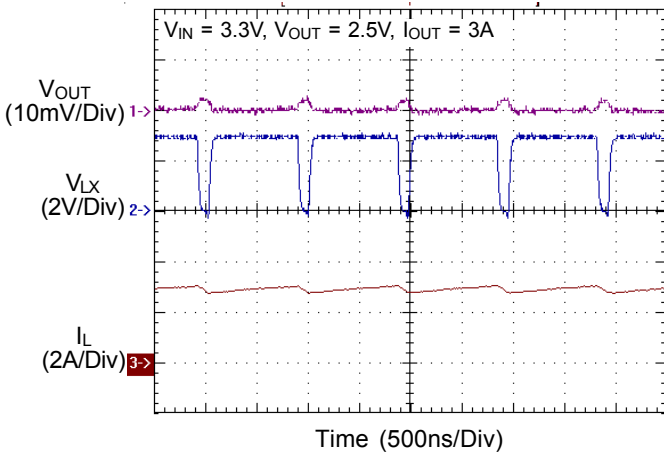

Load Transient Response

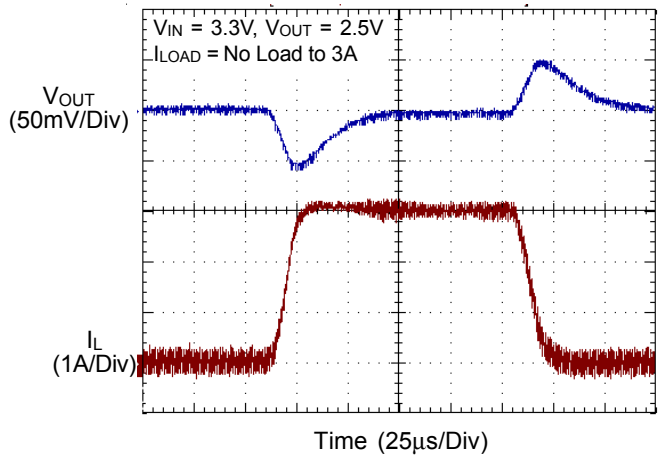

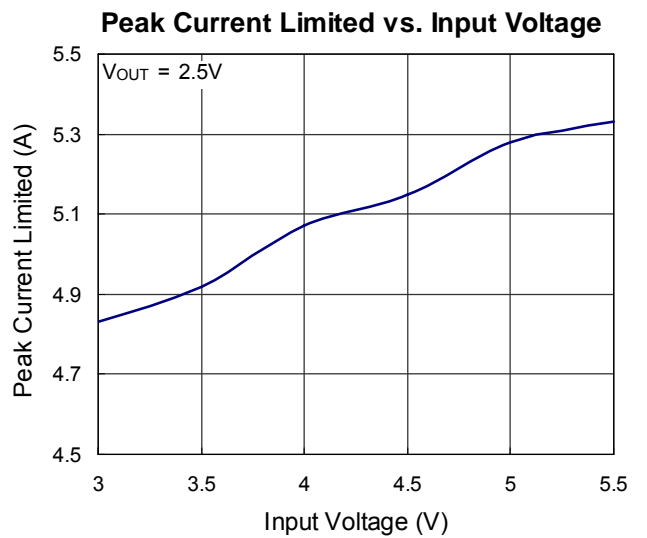
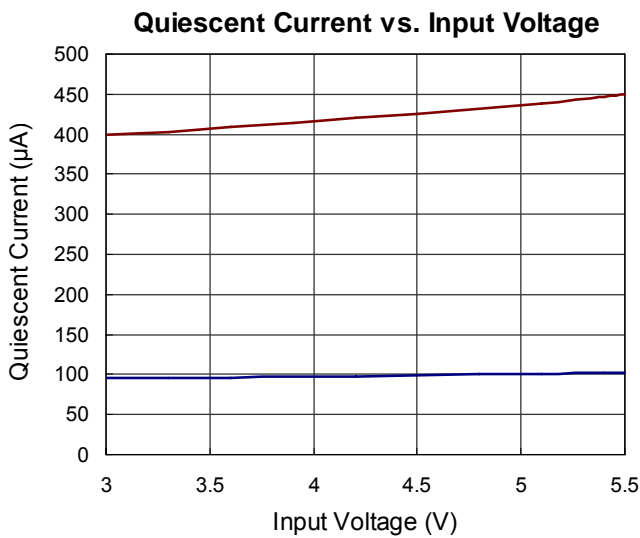
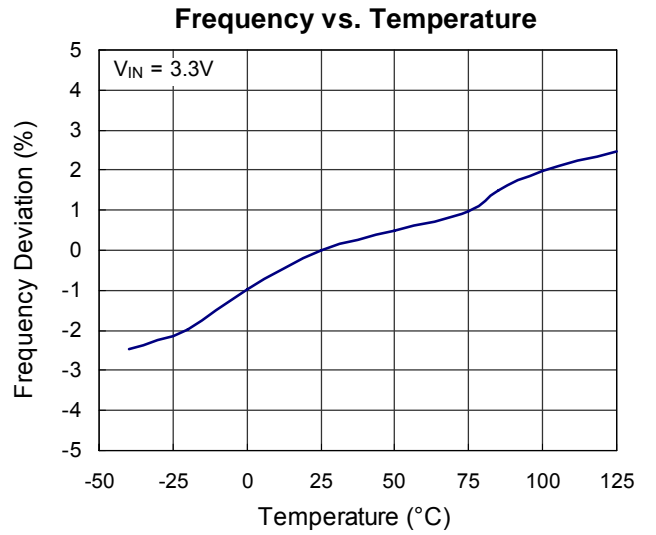
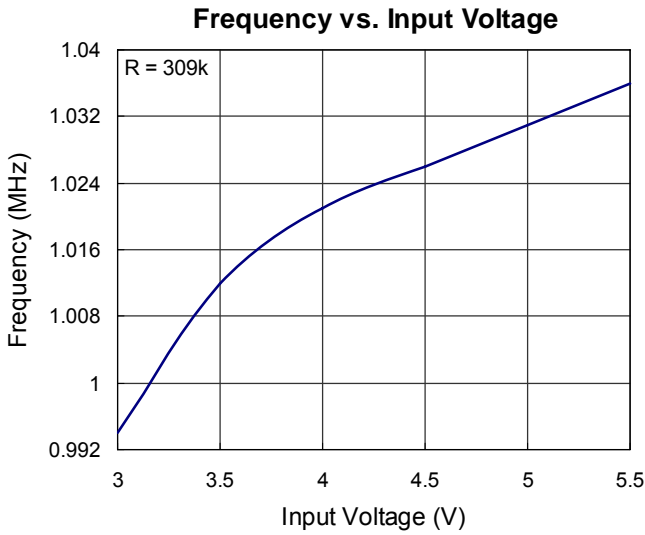
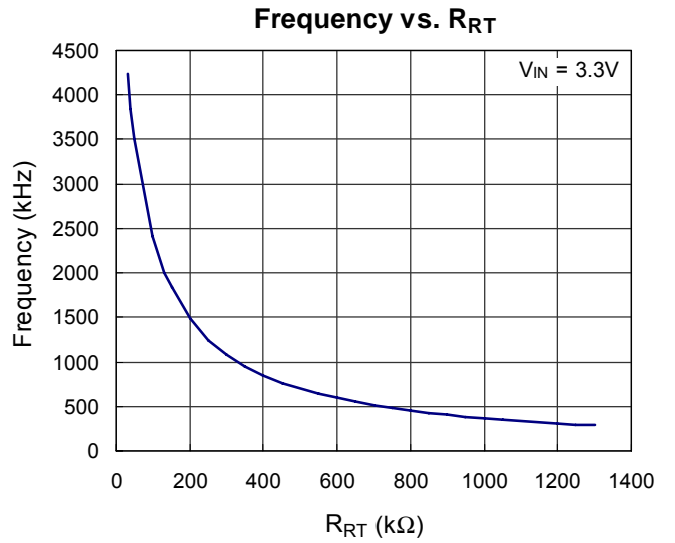
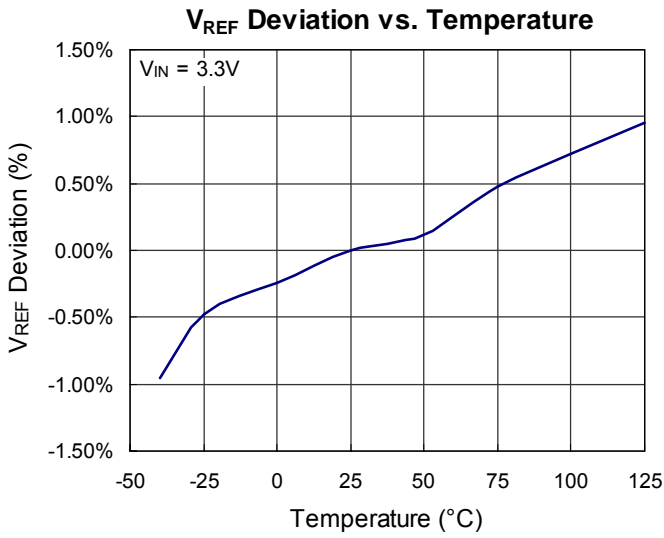

Application Information

The basic RT8004 application circuit is shown in Typical Application Circuit. External component selection is determined by the maximum load current and begins with the selection of the inductor value and operating frequency followed by C_{IN} and C_{OUT} .

Operating Frequency

Selection of the operating frequency is a tradeoff between efficiency and component size. High frequency operation allows the use of smaller inductor and capacitor values. Operation at lower frequencies improves efficiency by reducing internal gate charge and switching losses but requires larger inductance values and/or capacitance to maintain low output ripple voltage.

The operating frequency of the RT8004 is determined by an external resistor that is connected between the RT pin and ground. The value of the resistor sets the ramp current that is used to charge and discharge an internal timing capacitor within the oscillator. The RT resistor value can be determined by examining the frequency vs. R_{RT} curve. Although frequencies as high as 4MHz are possible, the minimum on-time of the RT8004 imposes a minimum limit on the operating duty cycle. The minimum on-time is typically 110ns. Therefore, the minimum duty cycle is equal to $100 \times 110\text{ns} \times f(\text{Hz})$.

Inductor Selection

For a given input and output voltage, the inductor value and operating frequency determine the ripple current. The ripple current ΔI_L increases with higher V_{IN} and decreases with higher inductance.

$$\Delta I_L = \left[\frac{V_{OUT}}{f \times L} \right] \left[1 - \frac{V_{OUT}}{V_{IN}} \right]$$

Having a lower ripple current reduces the ESR losses in the output capacitors and the output voltage ripple. Highest efficiency operation is achieved at low frequency with small ripple current. This, however, requires a large inductor.

A reasonable starting point for selecting the ripple current is $\Delta I_L = 0.4(I_{MAX})$. The largest ripple current occurs at the highest V_{IN} . To guarantee that the ripple current stays below a specified maximum, the inductor value should be

chosen according to the following equation :

$$L = \left[\frac{V_{OUT}}{f \times \Delta I_L(\text{MAX})} \right] \left[1 - \frac{V_{OUT}}{V_{IN}(\text{MAX})} \right]$$

Inductor Core Selection

Once the value for L is known, the type of inductor must be selected. High efficiency converters generally cannot afford the core loss found in low cost powdered iron cores, forcing the use of more expensive ferrite or mollypermalloy cores. Actual core loss is independent of core size for a fixed inductor value but it is very dependent on the inductance selected. As the inductance increases, core losses decrease. Unfortunately, increased inductance requires more turns of wire and therefore copper losses will increase.

Ferrite designs have very low core losses and are preferred at high switching frequencies, so design goals can concentrate on copper loss and preventing saturation. Ferrite core material saturates "hard", which means that inductance collapses abruptly when the peak design current is exceeded. This results in an abrupt increase in inductor ripple current and consequent output voltage ripple. Do not allow the core to saturate!

Different core materials and shapes will change the size/current and price/current relationship of an inductor.

Toroid or shielded pot cores in ferrite or permalloy materials are small and don't radiate energy but generally cost more than powdered iron core inductors with similar characteristics. The choice of which style inductor to use mainly depends on the price vs size requirements and any radiated field/EMI requirements.

C_{IN} and C_{OUT} Selection

The input capacitance, C_{IN} , is needed to filter the trapezoidal current at the source of the top MOSFET. To prevent large ripple voltage, a low ESR input capacitor sized for the maximum RMS current should be used. RMS current is given by :

$$I_{RMS} = I_{OUT(\text{MAX})} \frac{V_{OUT}}{V_{IN}} \sqrt{\frac{V_{IN}}{V_{OUT}} - 1}$$

This formula has a maximum at $V_{IN} = 2V_{OUT}$, where $I_{RMS} = I_{OUT}/2$. This simple worst-case condition is commonly used for design because even significant deviations do not offer much relief. Note that ripple current ratings from capacitor manufacturers are often based on only 2000 hours of life which makes it advisable to further derate the capacitor, or choose a capacitor rated at a higher temperature than required. Several capacitors may also be paralleled to meet size or height requirements in the design.

The selection of C_{OUT} is determined by the effective series resistance (ESR) that is required to minimize voltage ripple and load step transients, as well as the amount of bulk capacitance that is necessary to ensure that the control loop is stable. Loop stability can be checked by viewing the load transient response as described in a later section. The output ripple, ΔV_{OUT} , is determined by :

$$\Delta V_{OUT} \leq \Delta I_L \left[ESR + \frac{1}{8fC_{OUT}} \right]$$

The output ripple is highest at maximum input voltage since ΔI_L increases with input voltage. Multiple capacitors placed in parallel may be needed to meet the ESR and RMS current handling requirements. Dry tantalum, special polymer, aluminum electrolytic and ceramic capacitors are all available in surface mount packages. Special polymer capacitors offer very low ESR but have lower capacitance density than other types. Tantalum capacitors have the highest capacitance density but it is important to only use types that have been surge tested for use in switching power supplies. Aluminum electrolytic capacitors have significantly higher ESR but can be used in cost-sensitive applications provided that consideration is given to ripple current ratings and long term reliability. Ceramic capacitors have excellent low ESR characteristics but can have a high voltage coefficient and audible piezoelectric effects. The high Q of ceramic capacitors with trace inductance can also lead to significant ringing.

Using Ceramic Input and Output Capacitors

Higher values, lower cost ceramic capacitors are now becoming available in smaller case sizes. Their high ripple current, high voltage rating and low ESR make them ideal for switching regulator applications. However, care must

be taken when these capacitors are used at the input and output. When a ceramic capacitor is used at the input and the power is supplied by a wall adapter through long wires, a load step at the output can induce ringing at the input, V_{IN} . At best, this ringing can couple to the output and be mistaken as loop instability. At worst, a sudden inrush of current through the long wires can potentially cause a voltage spike at V_{IN} large enough to damage the part.

Output Voltage Programming

The output voltage is set by an external resistive divider according to the following equation :

$$V_{OUT} = 0.8V \left(1 + \frac{R2}{R1} \right)$$

The resistive divider allows the V_{FB} pin to sense a fraction of the output voltage as shown in Figure 1.

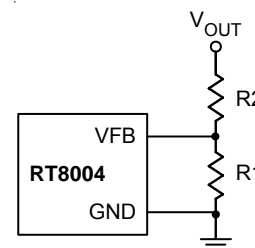

Figure 1. Setting the Output Voltage

Frequency Synchronization

The RT8004's internal oscillator can be synchronized to an external clock signal. During synchronization, the top MOSFET turn-on is locked to the falling edge of the external frequency source. The synchronization frequency range is 300kHz to 4MHz. Synchronization only occurs if the external frequency is greater than the frequency set by the external resistor. Because slope compensation is generated by the oscillator's RC circuit, the external frequency should be set 25% higher than the frequency set by the external resistor to ensure that adequate slope compensation is present.

Soft-Start

The EN/SS pin provides a means to shut down the RT8004 as well as a timer for soft-start. Pulling the EN/SS pin below 0.5V places the RT8004 in a low quiescent current shutdown state ($I_Q < 1\mu A$).

The RT8004 contains an internal soft-start clamp that gradually raises the clamp on COMP after the EN/SS pin is pulled above 0.8V. The full current range becomes available on COMP after 1024 switching cycles. If a longer soft-start period is desired, the clamp on COMP can be set externally with a resistor and capacitor on the EN/SS pin as shown in Typical Application Circuit. The soft-start duration can be calculated by using the following formula:

$$T_{SS} = R_{SS} \times C_{SS} \times \ln\left(\frac{V_{IN}}{V_{IN} - 1.8V}\right) \text{ (s)}$$

Efficiency Considerations

The efficiency of a switching regulator is equal to the output power divided by the input power times 100%. It is often useful to analyze individual losses to determine what is limiting the efficiency and which change would produce the most improvement. Efficiency can be expressed as:

$$\text{Efficiency} = 100\% - (L1 + L2 + L3 + \dots)$$

where L1, L2, etc. are the individual losses as a percentage of input power. Although all dissipative elements in the circuit produce losses, two main sources usually account for most of the losses: VDD quiescent current and I²R losses. The VDD quiescent current loss dominates the efficiency loss at very low load currents whereas the I²R loss dominates the efficiency loss at medium to high load currents. In a typical efficiency plot, the efficiency curve at very low load currents can be misleading since the actual power lost is of no consequence.

1. The VDD quiescent current is due to two components: the DC bias current as given in the electrical characteristics and the internal main switch and synchronous switch gate charge currents. The gate charge current results from switching the gate capacitance of the internal power MOSFET switches. Each time the gate is switched from high to low to high again, a packet of charge ΔQ moves from VDD to ground. The resulting ΔQ/Δt is the current out of VDD that is typically larger than the DC bias current. In continuous mode,

$$I_{GATECHG} = f(Q_T + Q_B)$$

where Q_T and Q_B are the gate charges of the internal top and bottom switches. Both the DC bias and gate charge

losses are proportional to V_{DD} and thus their effects will be more pronounced at higher supply voltages.

2. I²R losses are calculated from the resistances of the internal switches, R_{SW} and external inductor R_L. In continuous mode the average output current flowing through inductor L is “chopped” between the main switch and the synchronous switch. Thus, the series resistance looking into the LX pin is a function of both top and bottom MOSFET R_{DS(ON)} and the duty cycle (DC) as follows :

$$R_{SW} = R_{DS(ON)TOP} \times DC + R_{DS(ON)BOT} \times (1-DC)$$

The R_{DS(ON)} for both the top and bottom MOSFETs can be obtained from the Typical Performance Characteristics curves. Thus, to obtain I²R losses, simply add R_{SW} to R_L and multiply the result by the square of the average output current.

Other losses including C_{IN} and C_{OUT} ESR dissipative losses and inductor core losses generally account for less than 2% of the total loss.

Thermal Considerations

In most applications, the RT8004 does not dissipate much heat due to its high efficiency. But, in applications where the RT8004 is running at high ambient temperature with low supply voltage and high duty cycles, such as in dropout, the heat dissipated may exceed the maximum junction temperature of the part. If the junction temperature reaches approximately 150°C, both power switches will be turned off and the SW node will become high impedance. To avoid the RT8004 from exceeding the maximum junction temperature, the user will need to do some thermal analysis. The goal of the thermal analysis is to determine whether the power dissipated exceeds the maximum junction temperature of the part. The temperature rise is given by :

$$T_R = P_D \times \theta_{JA}$$

Where P_D is the power dissipated by the regulator and θ_{JA} is the thermal resistance from the junction of the die to the ambient temperature. The junction temperature, T_J, is given by :

$$T_J = T_A + T_R$$

Where T_A is the ambient temperature.

As an example, consider the RT8004 in dropout at an input voltage of 3.3V, a load current of 3A and an ambient temperature of 70°C. From the typical performance graph of switch resistance, the $R_{DS(ON)}$ of the P-Channel switch at 70°C is approximately 97mΩ. Therefore, power dissipated by the part is :

$$P_D = (I_{LOAD})^2 (R_{DS(ON)}) = (3A)^2 (97m\Omega) = 0.873W$$

For the TSSOP package, the θ_{JA} is 47°C/W. Thus the junction temperature of the regulator is :

$$T_J = 70^\circ C + (0.873W) (47^\circ C/W) = 111^\circ C$$

Which is below the maximum junction temperature of 125°C. Note that at higher supply voltages, the junction temperature is lower due to reduced switch resistance ($R_{DS(ON)}$).

Checking Transient Response

The regulator loop response can be checked by looking at the load transient response. Switching regulators take several cycles to respond to a step in load current. When a load step occurs, V_{OUT} immediately shifts by an amount equal to $\Delta I_{LOAD}(ESR)$, where ESR is the effective series resistance of C_{OUT} . ΔI_{LOAD} also begins to charge or discharge C_{OUT} generating a feedback error signal used by the regulator to return V_{OUT} to its steady-state value. During this recovery time, V_{OUT} can be monitored for overshoot or ringing that would indicate a stability problem. The COMP pin external components and output capacitor shown in Typical Application Circuit will provide adequate compensation for most applications.

Layout Considerations

Follow the PCB layout guidelines for optimal performance of RT8004.

- ◀ A ground plane is recommended. If a ground plane layer is not used, the signal and power grounds should be segregated with all small-signal components returning to the GND pin at one point that is then connected to the PGND pin close to the IC. The exposed pad should be connected to GND.
- ◀ Connect the terminal of the input capacitor(s), C_{IN} , as close as possible to the PVDD pin. This capacitor provides the AC current into the internal power MOSFETs.

- ◀ LX node is with high frequency voltage swing and should be kept small area. Keep all sensitive small-signal nodes away from LX node to prevent stray capacitive noise pick-up.
- ◀ Flood all unused areas on all layers with copper. Flooding with copper will reduce the temperature rise of power components. You can connect the copper areas to any DC net (PVIN, SVIN, V_{OUT} , PGND, SGND, or any other DC rail in your system).
- ◀ Connect the FB pin directly to the feedback resistors. The resistor divider must be connected between V_{OUT} and GND.

Outline Dimension

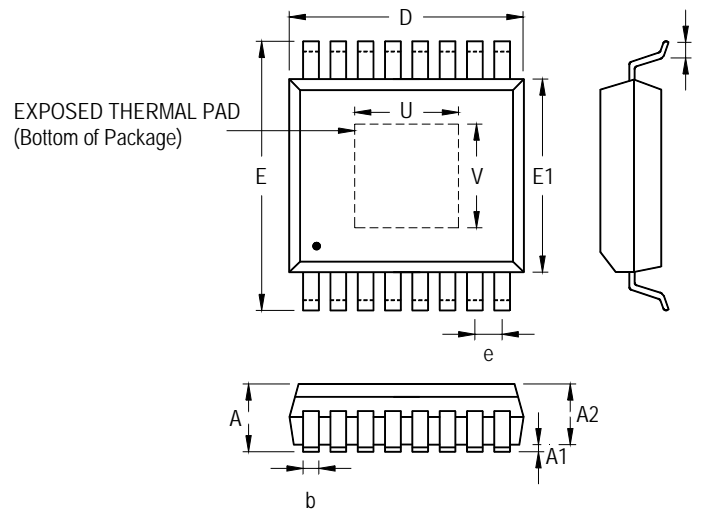

Symbol	Dimensions In Millimeters		Dimensions In Inches	
	Min	Max	Min	Max
A	1.000	1.200	0.039	0.047
A1	0.000	0.150	0.000	0.006
A2	0.800	1.050	0.031	0.041
b	0.190	0.300	0.007	0.012
D	4.900	5.100	0.193	0.201
e	0.65		0.026	
E	6.300	6.500	0.248	0.256
E1	4.300	4.500	0.169	0.177
L	0.450	0.750	0.018	0.030
U	2.000	3.000	0.079	0.118
V	2.000	3.000	0.079	0.118

16-Lead TSSOP (Exposed Pad) Plastic Package

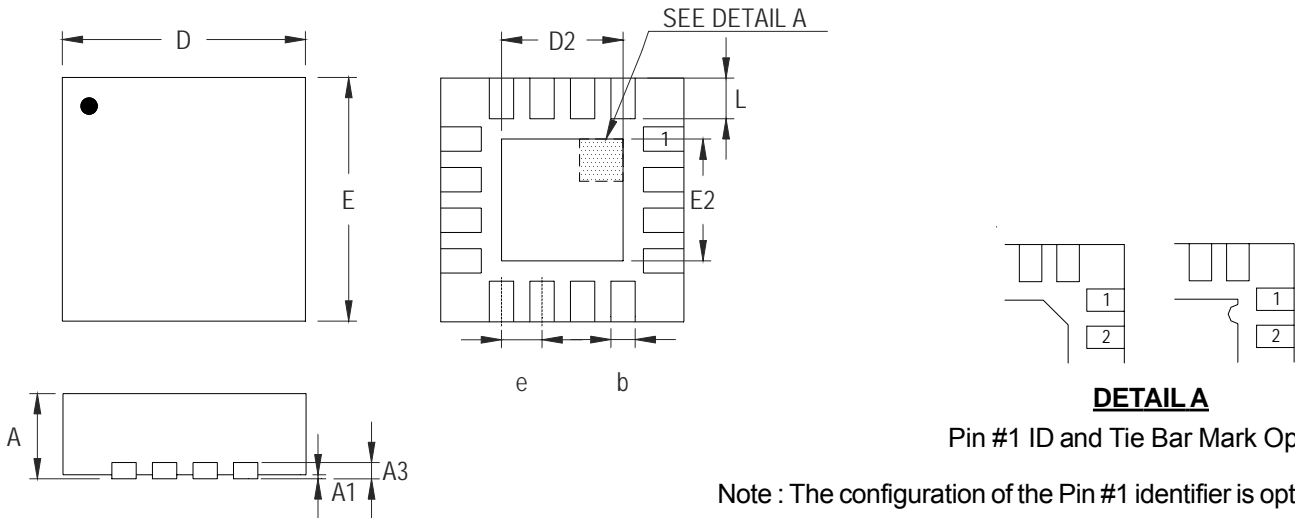

Pin #1 ID and Tie Bar Mark Options

Note : The configuration of the Pin #1 identifier is optional, but must be located within the zone indicated.

Symbol	Dimensions In Millimeters		Dimensions In Inches	
	Min	Max	Min	Max
A	0.800	1.000	0.031	0.039
A1	0.000	0.050	0.000	0.002
A3	0.175	0.250	0.007	0.010
b	0.250	0.380	0.010	0.015
D	3.950	4.050	0.156	0.159
D2	2.000	2.450	0.079	0.096
E	3.950	4.050	0.156	0.159
E2	2.000	2.450	0.079	0.096
e	0.650		0.026	
L	0.500	0.600	0.020	0.024

V-Type 16L VQFN 4x4 Package

Richtek Technology Corporation

Headquarter
 5F, No. 20, Taiyuen Street, Chupei City
 Hsinchu, Taiwan, R.O.C.
 Tel: (8863)5526789 Fax: (8863)5526611



Richtek Technology Corporation

Taipei Office (Marketing)
 5F, No. 95, Minchiuan Road, Hsintien City
 Taipei County, Taiwan, R.O.C.
 Tel: (8862)86672399 Fax: (8862)86672377
 Email: marketing@richtek.com

Information that is provided by Richtek Technology Corporation is believed to be accurate and reliable. Richtek reserves the right to make any change in circuit design, specification or other related things if necessary without notice at any time. No third party intellectual property infringement of the applications should be guaranteed by users when integrating Richtek products into any application. No legal responsibility for any said applications is assumed by Richtek.

Looking for pricing, stock, or lifecycle information?

Click below to explore more details on WIN SOURCE:

-  [View RT8004GQV on WIN SOURCE](#)
-  [Richtek USA Inc. Information](#)

Optimize Your Supply Chain with WIN SOURCE Solutions

-  Global Sourcing Solution
-  Obsolete Management
-  Cost Control Management
-  Shortage Management
-  Alternative Solution
-  Excess Inventory Management