



**THE DATASHEET OF  
E3FB-TP11 2M**



## M18 Plastic and Metal Housing Sensors

- Universal M18 cylindrical plastic or nickel-plated brass housing in straight or 90° angled models
- Rugged IP67, IP69K housing withstands high-pressure and high-temperature wash down
- High power red LED for easy sensor alignment and dependable outputs in dusty environments
- Compact and robust housing for easy integration into machines
- Retro-reflective models are polarized to prevent false reads on mirrored surfaces
- High EMC protection and ambient light immunity for detection stability in environments with excess noise or background light



## Unrivaled Detection with Simplicity in Setup and Installation

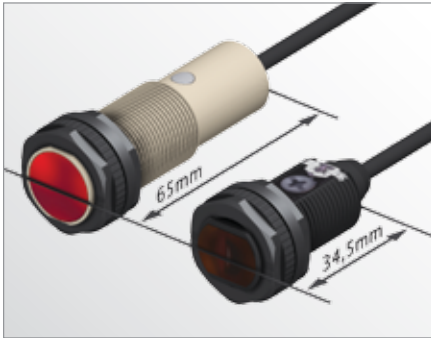

The short body of the E3FA/E3RA fits in tighter mounting spaces.



Visible red LED light for easy alignment.

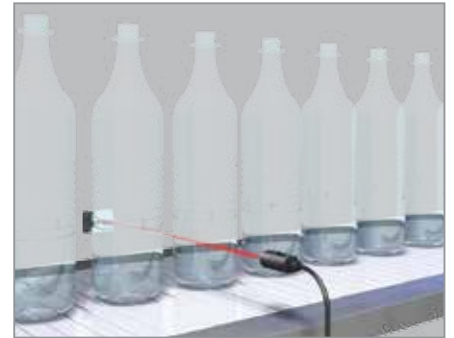

Transparent object detection sensors utilize Omron's unique technology for detecting objects with birefringent (double refraction) properties.



Bright LED indicators for status visibility and large sensor adjusters for use with a standard size screwdriver.

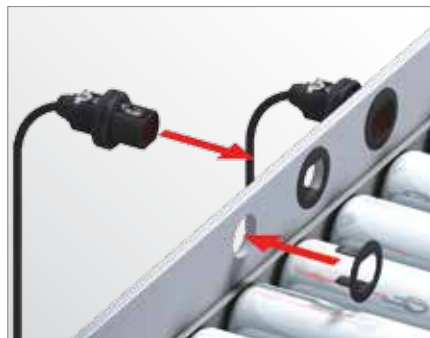

Flush mounting option for quick and easy installation.



High power LED to compensate for dirt and misalignment.



















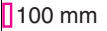

# E3FA/E3RA/E3FB/E3RB

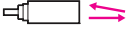
## Ordering Information

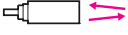

**Sensors (E3FA Plastic housing)** [Refer to *Dimensions on page 16.*]

 Red light  Infrared light

Sensor type	Sensing distance	Connection method	Model	
			NPN output	PNP output
Through-beam *1. 	 20 m	pre-wired	set E3FA-TN11 2M	set E3FA-TP11 2M
		M12 connector	set E3FA-TN21	set E3FA-TP21
	 15 m	pre-wired	set E3FA-TN12 2M	set E3FA-TP12 2M
		M12 connector	set E3FA-TN22	set E3FA-TP22
Retro-reflective with MSR function *2. 	 0.1 to 4 m with E39-R1S	pre-wired	E3FA-RN11 2M	E3FA-RP11 2M
		M12 connector	E3FA-RN21	E3FA-RP21
Coaxial Retro-reflective with MSR function *2. 	 0 to 500 mm with E39-R1S	pre-wired	E3FA-RN12 2M	E3FA-RP12 2M
		M12 connector	E3FA-RN22	E3FA-RP22
Diffuse-reflective 	 100 mm	pre-wired	E3FA-DN11 2M	E3FA-DP11 2M
		M12 connector	E3FA-DN21	E3FA-DP21
	 300 mm	pre-wired	E3FA-DN12 2M	E3FA-DP12 2M
		M12 connector	E3FA-DN22	E3FA-DP22
	 1 m	pre-wired	E3FA-DN13 2M	E3FA-DP13 2M
		M12 connector	E3FA-DN23	E3FA-DP23
	 100 mm	pre-wired	E3FA-DN14 2M	E3FA-DP14 2M
		M12 connector	E3FA-DN24	E3FA-DP24
	 300 mm	pre-wired	E3FA-DN15 2M	E3FA-DP15 2M
		M12 connector	E3FA-DN25	E3FA-DP25
	 1 m	pre-wired	E3FA-DN16 2M	E3FA-DP16 2M
		M12 connector	E3FA-DN26	E3FA-DP26
BGS (background suppression) 	 100 mm	pre-wired	E3FA-LN11 2M	E3FA-LP11 2M
		M12 connector	E3FA-LN21	E3FA-LP21
	 200 mm	pre-wired	E3FA-LN12 2M	E3FA-LP12 2M
		M12 connector	E3FA-LN22	E3FA-LP22
Limited distance reflective 	 10 to 50 mm	pre-wired	E3FA-VN11 2M	E3FA-VP11 2M
		M12 connector	E3FA-VN21	E3FA-VP21
Transparent detected with P-opaqing function *2. 	 100 to 500 mm with E39-RP1	pre-wired	E3FA-BN11 2M	E3FA-BP11 2M
		M12 connector	E3FA-BN21	E3FA-BP21
Transparent detected with P-opaqing function *2. 	 0.1 to 2 m with E39-RP1	pre-wired	E3FA-BN12 2M	E3FA-BP12 2M
		M12 connector	E3FA-BN22	E3FA-BP22







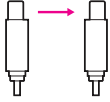

\*1. The set type includes the emitter and receiver.

\*2. The Reflector is sold separately. Select the Reflector model most suited to the application.

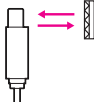

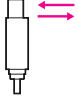
## Sensors (E3RA Plastic housing) [Refer to Dimensions on page 16.]

 Red light

Sensor type	Sensing distance	Connection method	Model	
			NPN output	PNP output
Through-beam *1. 	 15 m	pre-wired	set E3RA-TN11 2M	set E3RA-TP11 2M
		M12 connector	set E3RA-TN21	set E3RA-TP21
Retro-reflective with MSR function *2. 	 0.1 to 3 m with E39-R1S	pre-wired	E3RA-RN11 2M	E3RA-RP11 2M
		M12 connector	E3RA-RN21	E3RA-RP21
Diffuse-reflective 	 100 mm	pre-wired	E3RA-DN11 2M	E3RA-DP11 2M
		M12 connector	E3RA-DN21	E3RA-DP21
	 300 mm	pre-wired	E3RA-DN12 2M	E3RA-DP12 2M
		M12 connector	E3RA-DN22	E3RA-DP22
	 700 mm	pre-wired	E3RA-DN13 2M	E3RA-DP13 2M
		M12 connector	E3RA-DN23	E3RA-DP23

\*1. The set type includes the emitter and receiver.

















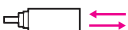







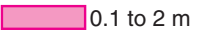
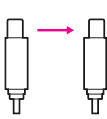

\*2. The Reflector is sold separately. Select the Reflector model most suited to the application.

# E3FA/E3RA/E3FB/E3RB

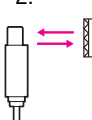

## Sensors (E3FB/E3RB Metal housing) [Refer to Dimensions on page 17.]

 Red light



Sensor type	Sensing distance	Connection method	Model	
			NPN output	PNP output
Through-beam *1. 	 20 m	pre-wired	set E3FB-TN11 2M	set E3FB-TP11 2M
		M12 connector	set E3FB-TN21	set E3FB-TP21
Retro-reflective with MSR function *2. 	 0.1 to 4 m with E39-R1S	pre-wired	E3FB-RN11 2M	E3FB-RP11 2M
		M12 connector	E3FB-RN21	E3FB-RP21
Coaxial Retro-reflective with MSR function *2. 	 0 to 500 mm with E39-R1S	pre-wired	E3FB-RN12 2M	E3FB-RP12 2M
		M12 connector	E3FB-RN22	E3FB-RP22
Diffuse-reflective 	 100 mm	pre-wired	E3FB-DN11 2M	E3FB-DP11 2M
		M12 connector	E3FB-DN21	E3FB-DP21
	 300 mm	pre-wired	E3FB-DN12 2M	E3FB-DP12 2M
		M12 connector	E3FB-DN22	E3FB-DP22
	 1 m	pre-wired	E3FB-DN13 2M	E3FB-DP13 2M
		M12 connector	E3FB-DN23	E3FB-DP23
BGS (background suppression) 	 100 mm	pre-wired	E3FB-LN11 2M	E3FB-LP11 2M
		M12 connector	E3FB-LN21	E3FB-LP21
	 200 mm	pre-wired	E3FB-LN12 2M	E3FB-LP12 2M
		M12 connector	E3FB-LN22	E3FB-LP22
Limited distance reflective 	 10 to 50 mm	pre-wired	E3FB-VN11 2M	E3FB-VP11 2M
		M12 connector	E3FB-VN21	E3FB-VP21
Transparent detected with P-opaquistion function *2. 	 100 to 500 mm with E39-RP1	pre-wired	E3FB-BN11 2M	E3FB-BP11 2M
		M12 connector	E3FB-BN21	E3FB-BP21
Transparent detected with P-opaquistion function *2. 	 0.1 to 2 m with E39-RP1	pre-wired	E3FB-BN12 2M	E3FB-BP12 2M
		M12 connector	E3FB-BN22	E3FB-BP22
Through-beam *1. 	 15 m	pre-wired	set E3RB-TN11 2M	set E3RB-TP11 2M
		M12 connector	set E3RB-TN21	set E3RB-TP21
Retro-reflective with MSR function *2. 	 0.1 to 3 m with E39-R1S	pre-wired	E3RB-RN11 2M	E3RB-RP11 2M
		M12 connector	E3RB-RN21	E3RB-RP21
Diffuse-reflective 	 100 mm	pre-wired	E3RB-DN11 2M	E3RB-DP11 2M
		M12 connector	E3RB-DN21	E3RB-DP21
	 300 mm	pre-wired	E3RB-DN12 2M	E3RB-DP12 2M
		M12 connector	E3RB-DN22	E3RB-DP22
	 700 mm	pre-wired	E3RB-DN13 2M	E3RB-DP13 2M
		M12 connector	E3RB-DN23	E3RB-DP23

\*1. The set type includes the emitter and receiver.

\*2. The Reflector is sold separately. Select the Reflector model most suited to the application.



## Reflectors *[Refer to Dimensions on page 18.]*

Reflectors required for Retro-reflective Sensors: A Reflector is not provided with the Sensor. Be sure to order a Reflector separately.

Sensor	Sensing distance	Appearance	Model	Quantity	Remarks
E3FA-R□1 E3FB-R□1	0.1 to 4 m		E39-R1S	1	for E3FA-R□, E3RA-R□, E3FB-R□ and E3RB-R□
E3FA-R□2 E3FB-R□2	0 to 500 mm				
E3FA-B□1 E3FB-B□1	100 to 500 mm		E39-RP1	1	for E3FA-B□ and E3FB-B□
E3FA-B□2 E3FB-B□2	0.1 to 2 m				

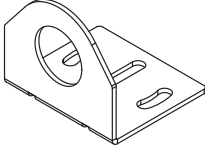

## Mounting brackets *[Refer to Dimensions on page 18.]*

A Mounting Bracket is not enclosed with the Sensor. Order a Mounting Bracket separately if required.

Sensor	Appearance	Model (Material)	Quantity	Remarks
all types		E39-L183 (SUS304)	1	Mounting bracket
E3FA-□ E3RA-□		E39-L182 (POM)	1	Flush mounting bracket

## Sensor I/O connectors

Models for Connectors: A Connector is not provided with the Sensor. Be sure to order a Connector separately.

Sensor	Size	Cable	Appearance	Cable type	Model
M12 connector types	M12	Standard	Straight 	2 m	XS2F-M12PVC4S2M
				5 m	XS2F-M12PVC4S5M
			Angle 	2 m	XS2F-M12PVC4A2M
				5 m	XS2F-M12PVC4A5M

## Model Number Legend

E3□-□□□□-(□)□  
1 2 3 4 5 6 7

### 1. Series name

FA: Cylindrical, Straight type, Plastic housing  
 RA: Cylindrical, Radial type, Plastic housing  
 FB: Cylindrical, Straight type, Metal housing  
 RB: Cylindrical, Radial type, Metal housing

### 2. Sensing method

T: Through-beam  
 R: Retro-reflective with MSR function  
 D: Diffuse-reflective  
 L: Background suppression  
 V: Limited distance reflective  
 B: Transparent detected with P-opaqing function

### 3. Output

P: PNP  
 N: NPN

### 4. Connection

1: Cable  
 2: Connector, M12, 4-pin

### 5. Difference of sensing distance, difference of light source

Sequential number

### 6. Emitter/Receiver

D: Receiver  
 L: Emitter

### 7. Cable length

Blank: Connector type

e.g., E3FA-TP11 2M;

Cylindrical, Straight type, Plastic housing/ Through-beam/ PNP/  
 Cable/ Difference of Sensing distance/ Cable length of 2M

E3RA-TN12-D;

Cylindrical, Radial type, Plastic housing/ Through-beam/ NPN/  
 Connector, M12, 4-pin/ Difference of Sensing distance/  
 Receiver/ Connector type

E3FA-VP12;

Cylindrical, Straight type, Plastic housing/ Limited distance  
 reflective/ PNP/ Connector, M12, 4-pin/ Difference of Sensing  
 distance/ Connector type

# E3FA/E3RA/E3FB/E3RB

## Ratings and Specifications

### Straight type (E3FA/E3FB)

Model	Sensing method		Through-beam		Retro-reflective with MSR function	Coaxial Retro-reflective with MSR function
	NPN output	Pre-wired M12 Connector	E3F□-TN11 2M	E3FA-TN12 2M	E3F□-RN11 2M	E3F□-RN12 2M
Item	PNP output	Pre-wired M12 Connector	E3F□-TP11 2M	E3FA-TP12 2M	E3F□-RP11 2M	E3F□-RP12 2M
			E3F□-TP21	E3FA-TP22	E3F□-RP21	E3F□-RP22
Sensing distance			20 m	15 m	0.1 to 4 m (with E39-R1S)	0 to 500 mm (with E39-R1S)
Spot diameter (reference value)			—			
Standard sensing object			Opaque: 7 mm dia.min.		Opaque: 75 mm dia.min.	
Differential travel			—			
Directional angle			2° min.			
Light source (wavelength)			Red LED (624 nm)	Infrared LED (850 nm)	Red LED (624 nm)	
Power supply voltage			10 to 30 VDC (include voltage ripple of 10%(p-p) max.)			
Current consumption			40 mA max. (Emitter 25 mA max. Receiver 15 mA max.)		25 mA max.	
Control output			NPN/PNP (open collector) Load current: 100 mA max. (Residual voltage: 3 V max.), Load power supply voltage: 30 VDC max.			
Operation mode			Light-ON/Dark-ON selectable by wiring			
Indicator			Operation indicator (orange) Stability indicator (green) Power indicator (green): only Emitter of Through-beam			
Protection circuits			Power supply reverse polarity protection, Output short-circuit protection, and Output reverse polarity protection			
Response time			0.5 ms			
Sensitivity adjustment			One-turn adjuster			
Ambient illumination (Receiver side)			Incandescent lamp: 3,000 lx max./ Sunlight: 10,000 lx max.			
Ambient temperature range			Operating: -25 to 55°C/ Storage: -30 to 70°C (with no icing or condensation)			
Ambient humidity range			Operating: 35 to 85%/ Storage: 35 to 95% (with no condensation)			
Insulation resistance			20 MΩ min. at 500 VDC			
Dielectric strength			1,000 VAC at 50/60 Hz for 1 min. between current-carrying parts and case			
Vibration resistance			Destruction: 10 to 55 Hz, 1.5 mm double amplitude for 2 hours each in X, Y and Z directions			
Shock resistance			Destruction: 500 m/s <sup>2</sup> 3 times each in X, Y and Z directions			
Degree of protection			IEC: IP67, DIN 40050-9: IP69K *			
Weight (packed state/only sensor)	Pre-wired cable (2M)		E3FA: Approx. 110 g/ Approx. 50 g, respectively, E3FB: Approx. 175 g/ Approx. 65 g, respectively		E3FA: Approx. 60 g/ Approx. 50 g, E3FB: Approx. 95 g/ Approx. 65 g	
	Connector		E3FA: Approx. 30 g/ Approx. 10 g, respectively, E3FB: Approx. 85 g/ Approx. 20 g, respectively		E3FA: Approx. 20 g/ Approx. 10 g, E3FB: Approx. 50 g/ Approx. 20 g	
Material	Case		E3FA: ABS, E3FB: Nickel-brass			
	Lens and Display		PMMA			
	Adjuster		POM			
	Nut		E3FA: POM, E3FB: Nickel-brass			
Accessories			Instruction sheet M18 nuts (4 pcs)		Instruction sheet M18 nuts (2 pcs)	

\* IP69K Degree of Protection Specifications

IP69K is a protection specification stipulated by DIN 40050 Part 9 of the German standards.

The test item is sprayed with 80°C water from a nozzle of a specified shape at a water pressure of 80 to 100 bar. The amount of water is 14 to 16 liters per minute.

The distance between the test item and the nozzle is 10 to 15 cm. The water is discharged at angles of 0°, 30°, 60°, and 90° from the horizontal plane for 30 seconds at each angle while the test item is rotated horizontally.

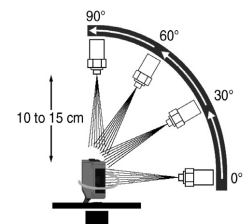

## Straight type (E3FA/E3FB)

Model	Sensing method		Diffuse-reflective					
	NPN output	Pre-wired M12 Connector	E3F□-DN11 2M	E3F□-DN12 2M	E3F□-DN13 2M	E3FA-DN14 2M	E3FA-DN15 2M	E3FA-DN16 2M
Item	PNP output	Pre-wired M12 Connector	E3F□-DP11 2M	E3F□-DP12 2M	E3F□-DP13 2M	E3FA-DP14 2M	E3FA-DP15 2M	E3FA-DP16 2M
				E3F□-DP21	E3F□-DP22	E3F□-DP23	E3FA-DP24	E3FA-DP25
<b>Sensing distance</b>			100 mm (white paper: 300 × 300 mm)	300 mm (white paper: 300 × 300 mm)	1 m (white paper: 300 × 300 mm)	100 mm (white paper: 300 × 300 mm)	300 mm (white paper: 300 × 300 mm)	1 m (white paper: 300 × 300 mm)
<b>Spot diameter (reference value)</b>			40 × 45 mm Sensing distance of 100 mm	40 × 50 mm Sensing distance of 300 mm	120 × 150 mm Sensing distance of 1 m	40 × 45 mm Sensing distance of 100 mm	40 × 50 mm Sensing distance of 300 mm	120 × 150 mm Sensing distance of 1 m
<b>Standard sensing object</b>			—					
<b>Differential travel</b>			20% max.					
<b>Directional angle</b>			—					
<b>Light source (wavelength)</b>			Red LED (624 nm)			Infrared LED (850 nm)		
<b>Power supply voltage</b>			10 to 30 VDC (include voltage ripple of 10%(p-p) max.)					
<b>Current consumption</b>			25 mA max.					
<b>Control output</b>			NPN/PNP (open collector) Load current: 100 mA max. (Residual voltage: 3 V max.), Load power supply voltage: 30 VDC max.					
<b>Operation mode</b>			Light-ON/Dark-ON selectable by wiring					
<b>Indicator</b>			Operation indicator (orange) Stability indicator (green)					
<b>Protection circuits</b>			Power supply reverse polarity protection, Output short-circuit protection, and Output reverse polarity protection					
<b>Response time</b>			0.5 ms					
<b>Sensitivity adjustment</b>			One-turn adjuster					
<b>Ambient illumination (Receiver side)</b>			Incandescent lamp: 3,000 lx max./ Sunlight: 10,000 lx max.					
<b>Ambient temperature range</b>			Operating: -25 to 55°C/ Storage: -30 to 70°C (with no icing or condensation)					
<b>Ambient humidity range</b>			Operating: 35 to 85%/ Storage: 35 to 95% (with no condensation)					
<b>Insulation resistance</b>			20 MΩ min. at 500 VDC					
<b>Dielectric strength</b>			1,000 VAC at 50/60 Hz for 1 min. between current-carrying parts and case					
<b>Vibration resistance</b>			Destruction: 10 to 55 Hz, 1.5 mm double amplitude for 2 hours each in X, Y and Z directions					
<b>Shock resistance</b>			Destruction: 500 m/s <sup>2</sup> 3 times each in X, Y and Z directions					
<b>Degree of protection</b>			IEC: IP67, DIN 40050-9: IP69K *					
<b>Weight (packed state/only sensor)</b>	<b>Pre-wired cable (2M)</b>	E3FA: Approx. 60 g/ Approx. 50 g, E3FB: Approx. 95 g/ Approx. 65 g						
	<b>Connector</b>	E3FA: Approx. 20 g/ Approx. 10 g, E3FB: Approx. 50 g/ Approx. 20 g						
<b>Material</b>	<b>Case</b>	E3FA: ABS, E3FB: Nickel-brass						
	<b>Lens and Display</b>	PMMA						
	<b>Adjuster</b>	POM						
	<b>Nut</b>	E3FA: POM, E3FB: Nickel-brass						
<b>Accessories</b>			Instruction sheet M18 nuts (2 pcs)					

\* IP69K Degree of Protection Specifications

IP69K is a protection specification stipulated by DIN 40050 Part 9 of the German standards.

The test item is sprayed with 80°C water from a nozzle of a specified shape at a water pressure of 80 to 100 bar. The amount of water is 14 to 16 liters per minute.

The distance between the test item and the nozzle is 10 to 15 cm. The water is discharged at angles of 0°, 30°, 60°, and 90° from the horizontal plane for 30 seconds at each angle while the test item is rotated horizontally.

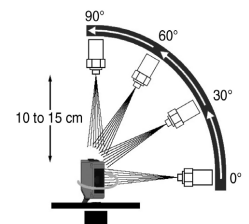

# E3FA/E3RA/E3FB/E3RB

## Straight type (E3FA/E3FB)

Model	Sensing method		BGS (Background suppression)		Limited distance reflective	Transparent detected with P-opaquiring function	
	NPN output	Pre-wired M12 Connector	E3F□-LN11 2M	E3F□-LN12 2M	E3F□-VN11 2M	E3F□-BN11 2M	E3F□-BN12 2M
Item	PNP output	Pre-wired	E3F□-LP11 2M	E3F□-LP12 2M	E3F□-VP11 2M	E3F□-BP11 2M	E3F□-BP12 2M
		M12 Connector	E3F□-LP21	E3F□-LP22	E3F□-VP21	E3F□-BP21	E3F□-BP22
Sensing distance			100 mm (white paper: 300 × 300 mm)	200 mm (white paper: 300 × 300 mm)	10 to 50 mm (glass(t = 1.0 mm): 150 × 150 mm)	100 to 500 mm (with E39-RP1)	0.1 to 2 m (with E39-RP1)
Spot diameter (reference value)			10 × 10 mm Sensing distance of 100 mm	10 × 15 mm Sensing distance of 200 mm	10 × 10 mm Sensing distance of 50 mm	—	
Standard sensing object			—			glass(t = 1.0 mm): 150 × 150 mm	
Differential travel			20% max.		—		
Directional angle			—				
Light source (wavelength)			Red LED (624 nm)				
Power supply voltage			10 to 30 VDC (include voltage ripple of 10%(p-p) max.)				
Current consumption			25 mA max.				
Control output			NPN/PNP (open collector) Load current: 100 mA max. (Residual voltage: 3 V max.), Load power supply voltage: 30 VDC max.				
Operation mode			Light-ON/Dark-ON selectable by wiring				
Indicator			Operation indicator (orange) Stability indicator (green)				
Protection circuits			Power supply reverse polarity protection, Output short-circuit protection, and Output reverse polarity protection				
Response time			0.5 ms				
Sensitivity adjustment			Fixed		One-turn adjuster		
Ambient illumination (Receiver side)			Incandescent lamp: 3,000 lx max./ Sunlight: 10,000 lx max.				
Ambient temperature range			Operating: -25 to 55°C/ Storage: -30 to 70°C (with no icing or condensation)				
Ambient humidity range			Operating: 35 to 85%/ Storage: 35 to 95% (with no condensation)				
Insulation resistance			20 MΩ min. at 500 VDC				
Dielectric strength			1,000 VAC at 50/60 Hz for 1 min. between current-carrying parts and case				
Vibration resistance			Destruction: 10 to 55 Hz, 1.5 mm double amplitude for 2 hours each in X, Y and Z directions				
Shock resistance			Destruction: 500 m/s <sup>2</sup> 3 times each in X, Y and Z directions				
Degree of protection			IEC: IP67, DIN 40050-9: IP69K *				
Weight (packed state/only sensor)	Pre-wired cable (2M)		E3FA: Approx. 60 g/ Approx. 50 g, E3FB: Approx. 95 g/ Approx. 65 g				
	Connector		E3FA: Approx. 20 g/ Approx. 10 g, E3FB: Approx. 50 g/ Approx. 20 g				
Material	Case		E3FA: ABS, E3FB: Nickel-brass				
	Lens and Display		PMMA				
	Adjuster		POM				
	Nut		E3FA: POM, E3FB: Nickel-brass				
Accessories			Instruction sheet M18 nuts (2 pcs)				

\* IP69K Degree of Protection Specifications

IP69K is a protection specification stipulated by DIN 40050 Part 9 of the German standards.

The test item is sprayed with 80°C water from a nozzle of a specified shape at a water pressure of 80 to 100 bar. The amount of water is 14 to 16 liters per minute.

The distance between the test item and the nozzle is 10 to 15 cm. The water is discharged at angles of 0°, 30°, 60°, and 90° from the horizontal plane for 30 seconds at each angle while the test item is rotated horizontally.

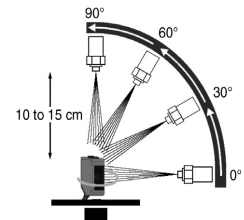

## Radial type (E3FA/E3FB)

Model	Sensing method		Through-beam	Retro-reflective with MSR function	Diffuse-reflective			
	NPN output	Pre-wired M12 Connector	E3R□-TN11 2M	E3R□-RN11 2M	E3R□-DN11 2M	E3R□-DN12 2M	E3R□-DN13 2M	
Item	PNP output	Pre-wired M12 Connector	E3R□-TP11 2M	E3R□-RP11 2M	E3R□-DP11 2M	E3R□-DP12 2M	E3R□-DP13 2M	
			E3R□-TP21	E3R□-RP21	E3R□-DP21	E3R□-DP22	E3R□-DP23	
Sensing distance			15 m	0.1 to 3 m (with E39-R1S)	100 mm (white paper: 300 × 300 mm)	300 mm (white paper: 300 × 300 mm)	700 mm (white paper: 300 × 300 mm)	
Spot diameter (reference value)			—		35 × 40 mm Sensing distance of 100 mm	40 × 45 mm Sensing distance of 300 mm	90 × 120 mm Sensing distance of 700 mm	
Standard sensing object			Opaque: 7 mm dia.min.	Opaque: 75 mm dia.min.	—			
Differential travel			—				20% max.	
Directional angle			2° min.				—	
Light source (wavelength)			Red LED (624 nm)					
Power supply voltage			10 to 30 VDC (include voltage ripple of 10%(p-p) max.)					
Current consumption			40mA max. (Emitter 25 mA max. Receiver 15 mA max.)	25 mA max.				
Control output			NPN/PNP (open collector) Load current: 100 mA max. (Residual voltage: 2 V max.), Load power supply voltage: 30 VDC max.					
Operation mode			Light-ON/Dark-ON selectable by wiring					
Indicator			Operation indicator (orange) Stability indicator (green) Power indicator (green): only Emitter of Through-beam					
Protection circuits			Power supply reverse polarity protection, Output short-circuit protection, and Output reverse polarity protection					
Response time			0.5 ms					
Sensitivity adjustment			One-turn adjuster					
Ambient illumination (Receiver side)			Incandescent lamp: 3,000 lx max./ Sunlight: 10,000 lx max.					
Ambient temperature range			Operating: -25 to 55°C/ Storage: -30 to 70°C (with no icing or condensation)					
Ambient humidity range			Operating: 35 to 85%/ Storage: 35 to 95% (with no condensation)					
Insulation resistance			20 MΩ min. at 500 VDC					
Dielectric strength			1,000 VAC at 50/60 Hz for 1 min. between current-carrying parts and case					
Vibration resistance			Destruction: 10 to 55 Hz, 1.5 mm double amplitude for 2 hours each in X, Y and Z directions					
Shock resistance			Destruction: 500 m/s <sup>2</sup> 3 times each in X, Y and Z directions					
Degree of protection			IEC: IP67, DIN 40050-9: IP69K *					
Weight (packed state/only sensor)	Pre-wired cable (2M)		E3RA: Approx. 110 g/ Approx. 50 g, respectively, E3RB: Approx. 175 g/ Approx. 65 g, respectively	E3RA: Approx. 60 g/ Approx. 50 g, E3RB: Approx. 95 g/ Approx. 65 g				
	Connector		E3RA: Approx. 30 g/ Approx. 10 g, respectively, E3RB: Approx. 85 g/ Approx. 20 g, respectively	E3RA: Approx. 20 g/ Approx. 10 g, E3RB: Approx. 50 g/ Approx. 20 g				
Material	Case		E3RA: ABS, E3RB: Nickel-brass					
	Lens and Display		PMMA					
	Adjuster		POM					
	Nut		E3RA: POM, E3RB: Nickel-brass					
Accessories			Instruction sheet M18 nuts (4 pcs)	Instruction sheet M18 nuts (2 pcs)				

\* IP69K Degree of Protection Specifications

IP69K is a protection specification stipulated by DIN 40050 Part 9 of the German standards.

The test item is sprayed with 80°C water from a nozzle of a specified shape at a water pressure of 80 to 100 bar. The amount of water is 14 to 16 liters per minute.

The distance between the test item and the nozzle is 10 to 15 cm. The water is discharged at angles of 0°, 30°, 60°, and 90° from the horizontal plane for 30 seconds at each angle while the test item is rotated horizontally.

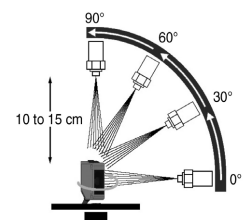

# E3FA/E3RA/E3FB/E3RB

## Engineering Data (Reference Value)

### Parallel Operating Range

#### Through-beam Models

E3F□-T□, E3R□-T□

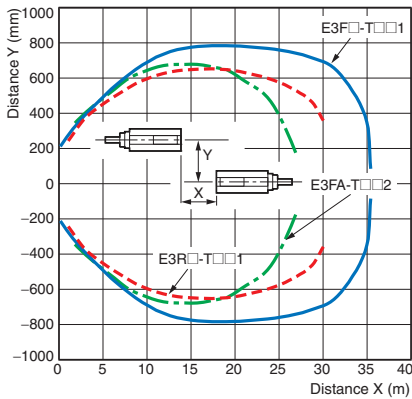

#### Retro-reflective Models (with MSR function)

E3F□-R□1, E3R□-R□1

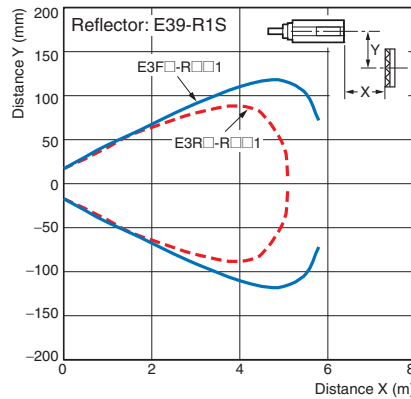

E3F□-R□2

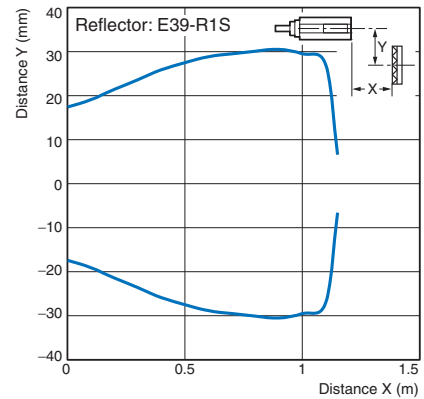

#### Transparent detected with P-opaqing function

E3F□-B□1

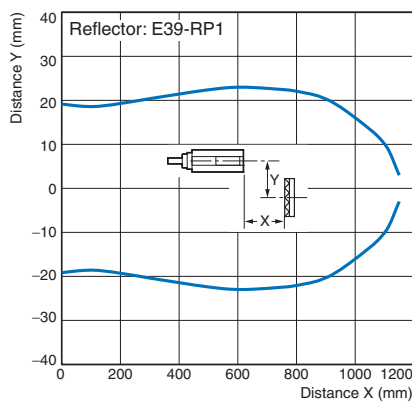

E3F□-B□2

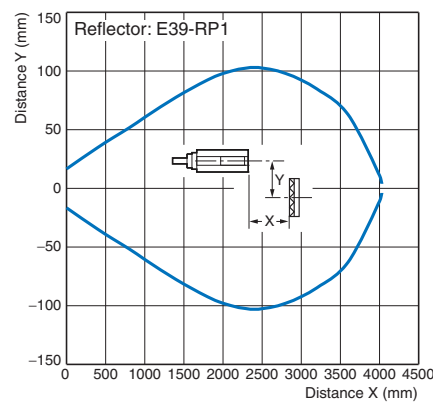

### Operating Range

#### Diffuse-reflective Models

E3F□-D□1, E3F□-D□2  
E3R□-D□1, E3R□-D□2

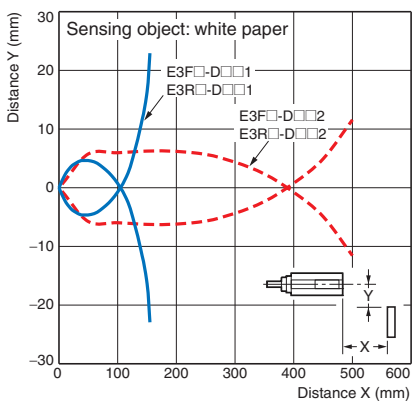

E3F□-D□3, E3R□-D□3

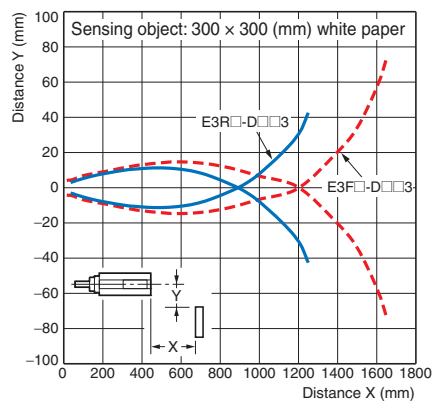

E3FA-D□4, E3FA-D□5

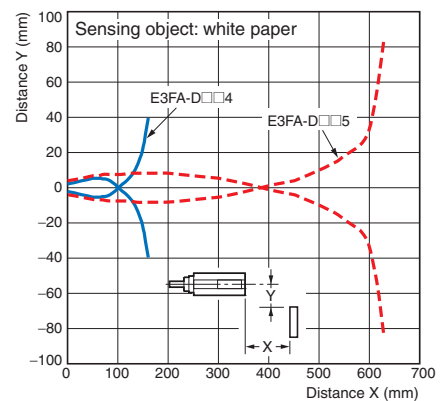

E3FA-D□6

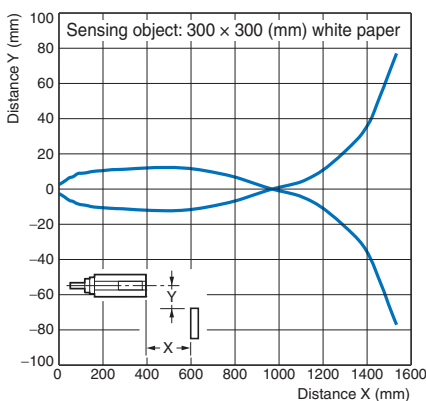

#### BGS Models

E3F□-L□1, E3F□-L□2

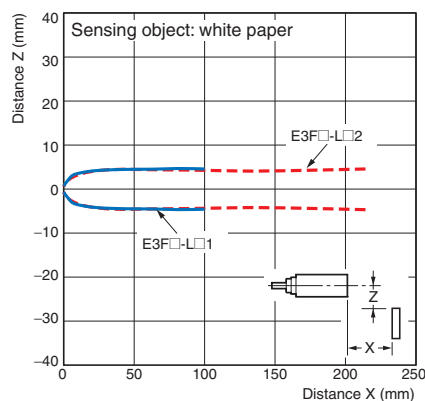

#### Limited distance reflective

E3F□-V□

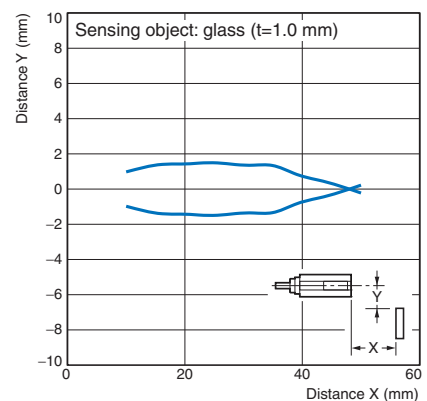

## Excess Gain vs. Distance

### Through-beam Models

E3F□-T□, E3R□-T□

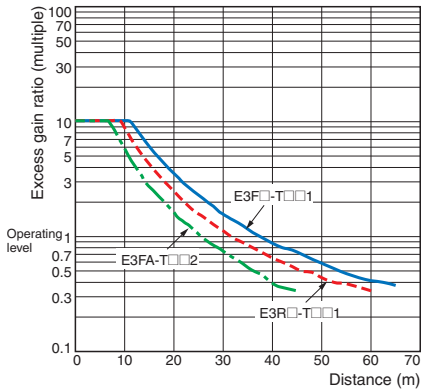

### Retro-reflective Models (with MSR function)

E3F□-R□1, E3R□-R□1

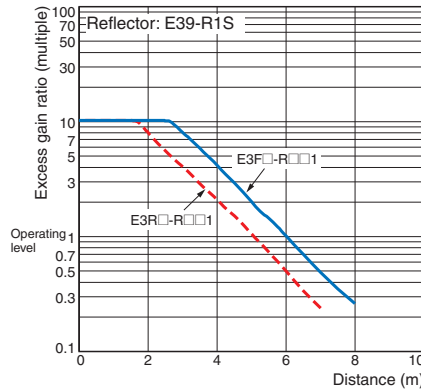

E3F□-R□2

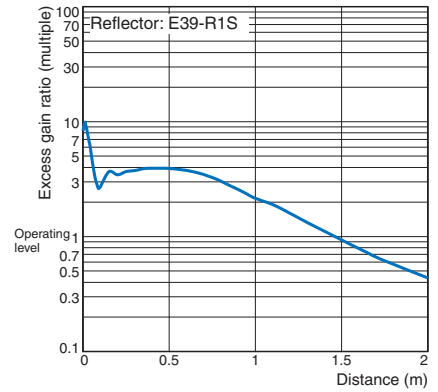

### Diffuse-reflective Models

E3F□-D□1, E3F□-D□2

E3R□-D□1, E3R□-D□2

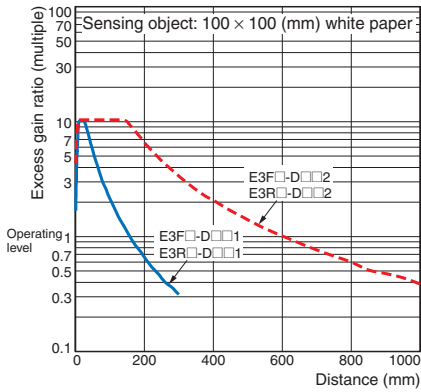

E3F□-D□3, E3R□-D□3

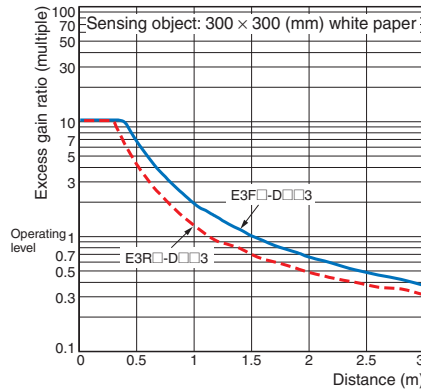

E3FA-D□4, E3FA-D□5

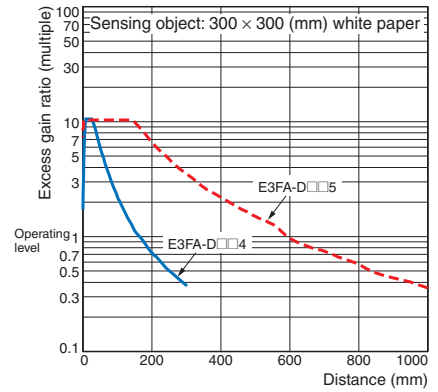

E3FA-D□6

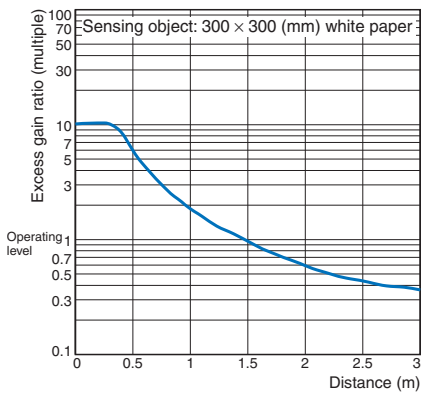

### Transparent detected with P-opaquiring function

E3F□-B□1, E3F□-B□2

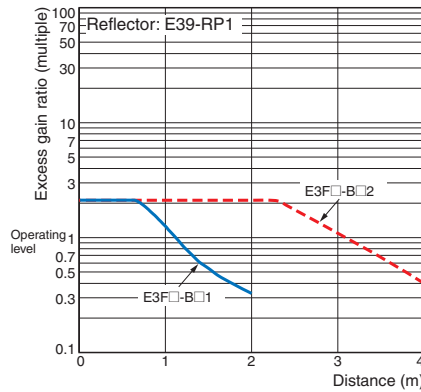

### Limited distance reflective

E3F□-V□

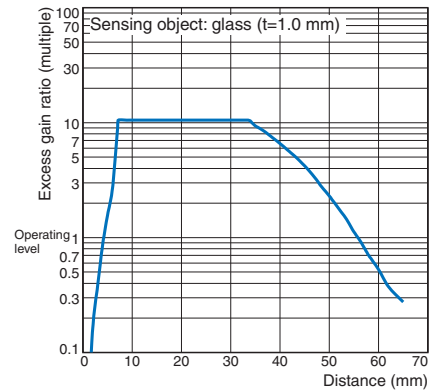

## Sensing Object Size vs. Distance

### Diffuse-reflective Models

E3F□-D□1, E3F□-D□2

E3R□-D□1, E3R□-D□2

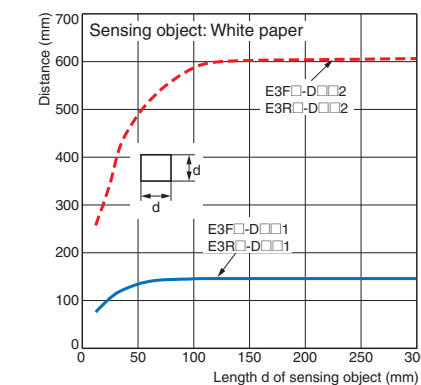

E3F□-D□3, E3R□-D□3

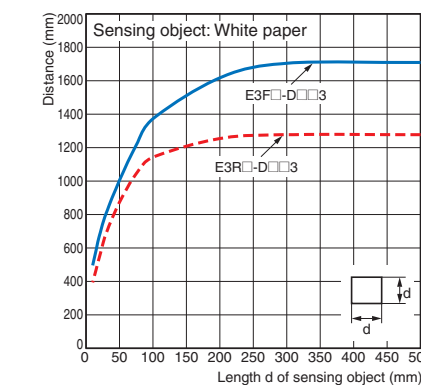

# E3FA/E3RA/E3FB/E3RB

## E3FA-D□4, E3FA-D□5

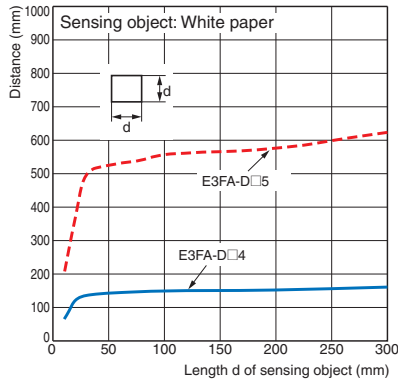

## E3FA-D□6

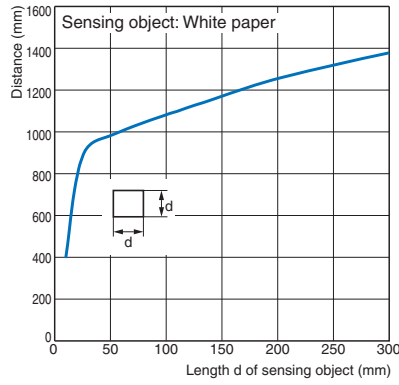

## Sensing Distance vs. Sensing Object Material

### BGS Models

#### E3F□-L□1

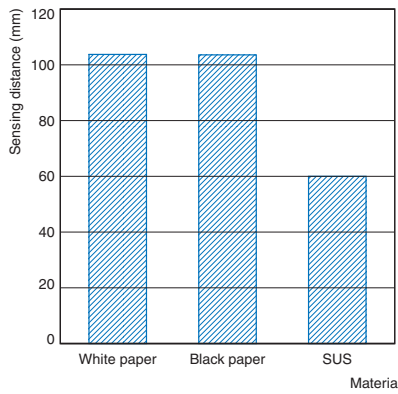

#### E3F□-L□2

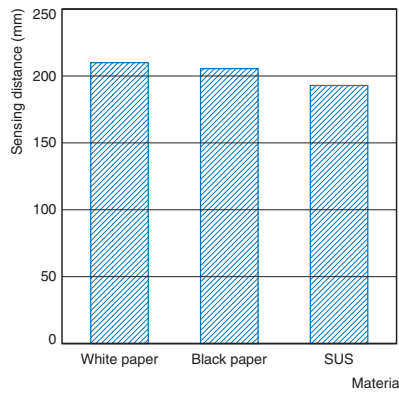

## Dark Excess Gain vs. Sensing Object Characteristics

### Transparent detected with P-opaqing function

#### E3F□-B□1

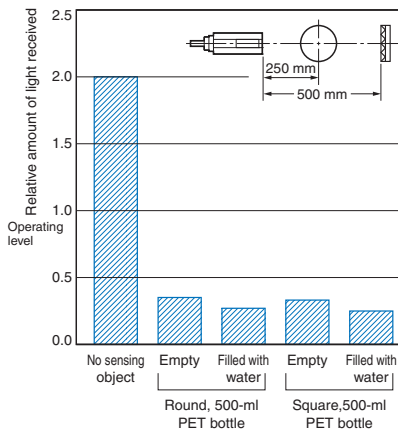

#### E3F□-B□2

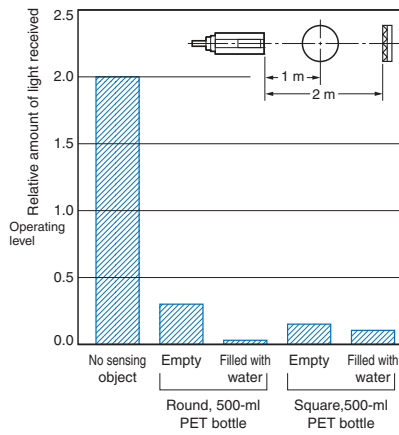

## Object Surface Color vs. Sensing Distance

### Diffuse-reflective Models

#### E3FA-D□4

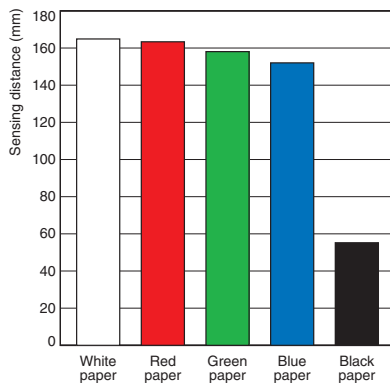

#### E3FA-D□5

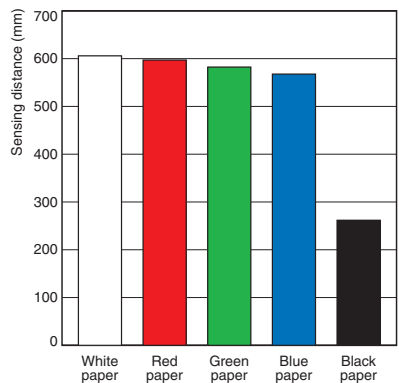

#### E3FA-D□6

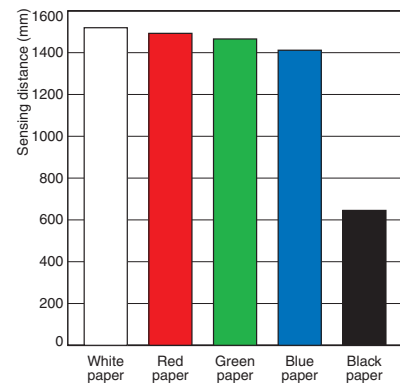

Output circuit diagram

PNP Output

Model	Operation mode	Timing charts	Operation selector	Output circuit
E3F□-TP□ E3F□-RP□ E3F□-DP□ E3F□-VP□ E3F□-BP□ E3R□-TP□ E3R□-RP□ E3R□-DP□	Light-ON		Connect the pink wire (Pin(2)) to the brown (Pin(1))	<p>Through-beam Receivers, Retro-reflective Models, Diffuse-reflective Models, Limited reflective Models. Transparent detected with P-opaquing function.</p>
	Dark-ON		Connect the pink wire (Pin(2)) to the blue (Pin(3)) or open the pink wire (Pin(2))	
<p>Through-beam Emitter</p>				
E3F□-LP□	Light-ON		Connect the pink wire (Pin(2)) to the brown (Pin(1))	<p>Background suppression.</p>
	Dark-ON		Connect the pink wire (Pin(2)) to the blue (Pin(3)) or open the pink wire (Pin(2))	

# E3FA/E3RA/E3FB/E3RB

## NPN Output

Model	Operation mode	Timing charts	Operation selector	Output circuit
E3F□-TN□ E3F□-RN□ E3F□-DN□ E3F□-VN□ E3F□-BN□ E3R□-TN□ E3R□-RN□ E3R□-DN□	Light-ON		Connect the pink wire (Pin(2)) to the brown (Pin(1)) or open the pink wire (Pin(2))	<p>Through-beam Receivers, Retro-reflective Models, Diffuse-reflective Models, Limited reflective Models. Transparent detected with P-opaquiring function.</p>
	Dark-ON		Connect the pink wire (Pin(2)) to the blue (Pin(3))	
<p>Through-beam Emitter</p>				
E3F□-LN□	Light-ON		Connect the pink wire (Pin(2)) to the brown (Pin(1)) or open the pink wire (Pin(2))	<p>Background suppression.</p>
	Dark-ON		Connect the pink wire (Pin(2)) to the blue (Pin(3))	

## Connector Pin Arrangement

### M12 Connector Pin Arrangement



## Connectors (Sensor I/O connectors)

### M12 4-wire Connectors

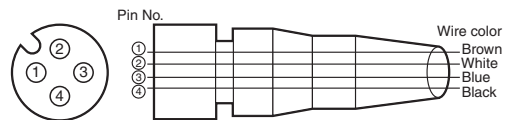

Classification	Wire color	Connector pin No.	Application
DC	Brown	①	Power supply (+V)
	White	②	L/on · D/on selectable
	Blue	③	Power supply (0 V)
	Black	④	Output

## Nomenclature

### Straight type, Plastic housing

with an adjuster:

E3FA-T□-D

E3FA-R□

E3FA-D□

E3FA-V□

E3FA-B□

without an adjuster:

E3FA-T□-L \*

E3FA-L□



### Radial type, Plastic housing

with an adjuster:

E3RA-T□-D

E3RA-R□

E3RA-D□

without an adjuster:

E3RA-T□-L \*



\* The Emitter has two Power indicators (Green) instead of the Stability indicator (Green) and the Operation indicator (Orange).

### Straight type, Metal housing

with an adjuster:

E3FB-T□-D

E3FB-R□

E3FB-D□

E3FB-V□

E3FB-B□

without an adjuster:

E3FB-T□-L \*

E3FB-L□



### Radial type, Metal housing

with an adjuster:

E3RB-T□-D

E3RB-R□

E3RB-D□

without an adjuster:

E3RB-T□-L \*



\* The Emitter has two Power indicators (Green) instead of the Stability indicator (Green) and the Operation indicator (Orange).

## Safety Precautions

### Refer to *Warranty and Limitations of Liability*.

#### WARNING

This product is not designed or rated for directly or indirectly ensuring safety of persons. Do not use it for such a purpose.



#### CAUTION

Never use the product with an AC power supply. Do not use the product with voltage in excess of the rated voltage.



Do not use the product with incorrect wiring. Otherwise, explosion, fire, malfunction may result.



#### Precautions for Safe Use

Be sure to follow the safety precautions below for added safety.

1. Do not use the sensor under the environment with explosive, flammable or corrosive gas.
2. Do not use the sensor under the oil or chemical environment.
3. Do not use the sensor in the water, rain or outdoors.
4. Do not use the sensor in the environment where humidity is high and condensation may occur.

5. Do not use the sensor under the environment under the other conditions in excess of rated.
6. Do not use the sensor in place that is exposed by direct sunlight.
7. Do not use the sensor in place where the sensor may receive direct vibration or shock.
8. Do not use the thinner, alcohol, or other organic solvents.
9. Never disassemble, repair nor tamper with the sensor.
10. Please process it as industrial waste.

#### Precautions for Correct Use

1. Laying Sensor wiring in the same conduit or duct as high-voltage wires or power lines may result in malfunction or damage due to conduit or use shielded cable.
2. Do not pull on the cable with excessive force.
3. If a commercial switching regulator is used, ground the FG (frame ground) terminal.
4. The sensor will be available 100 ms after the power supply is tuned ON. Start to use the sensor 100 ms or more after turning ON the power supply. If the load and the sensor are connected to separate power supplies, be sure to turn ON the sensor first.
5. Output pulses may be generated even when the power supply is OFF. Therefore, it is recommended to first turn OFF the power supply for the load or the load line.
6. The sensor must be mounted using the provided nuts. The proper tightening torque range of E3FA/E3RA plastic housing series is between 0.4 and 0.5 N·m. The proper tightening torque of E3FB/E3RB metal housing series is 20 N·m max..

# E3FA/E3RA/E3FB/E3RB

## Dimensions

(Unit: mm)  
Tolerance class IT16 applies to dimensions in this data sheet unless otherwise specified.

### Sensors (E3FA/E3RA Plastic housing)

#### E3FA series

##### Pre-wired Models

- E3FA-T□1□
- E3FA-R□1□
- E3FA-D□1□
- E3FA-L□1□
- E3FA-V□11
- E3FA-B□1□

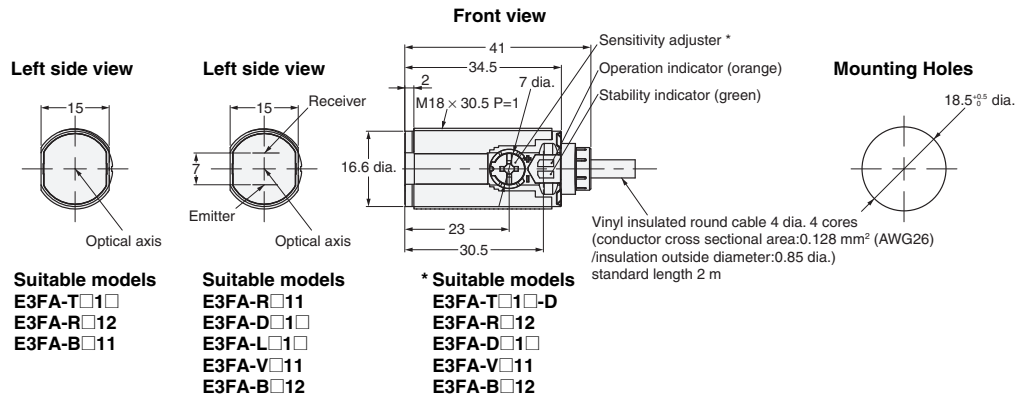

#### E3FA series

##### M12 Connector Models

- E3FA-T□2□
- E3FA-R□2□
- E3FA-D□2□
- E3FA-L□2□
- E3FA-V□21
- E3FA-B□2□

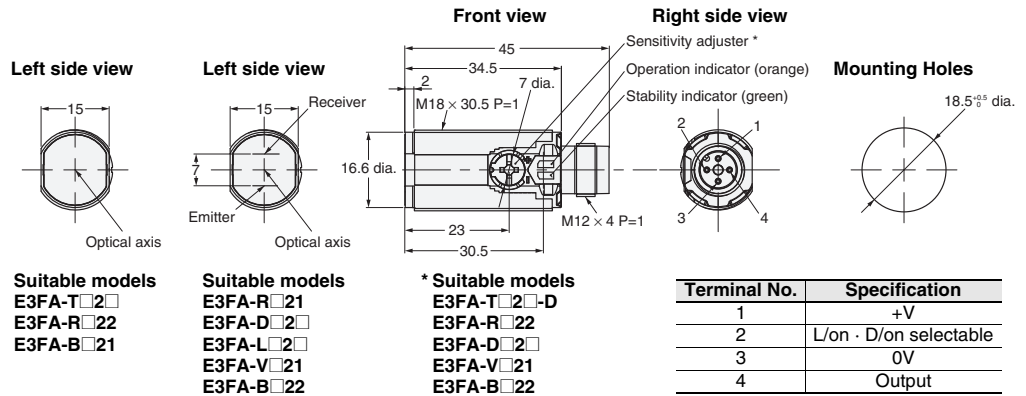

#### E3RA series

##### Pre-wired Models

- E3RA-T□11
- E3RA-R□11
- E3RA-D□1□

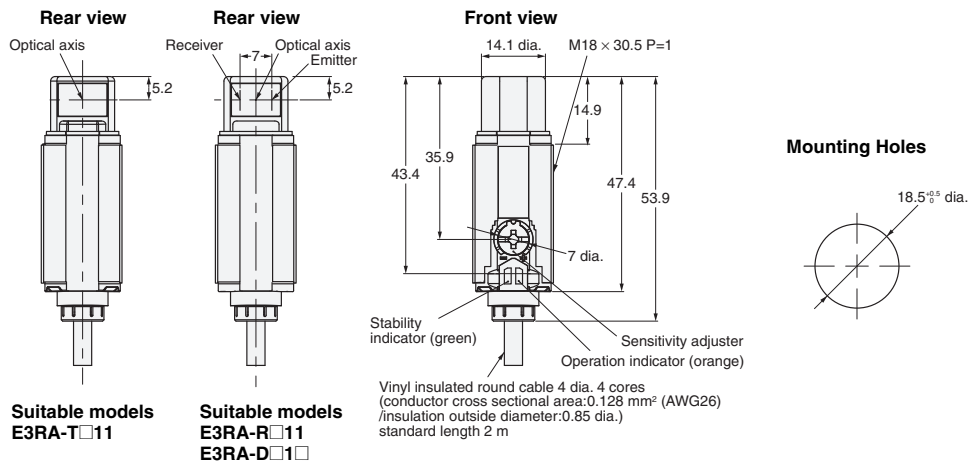

#### E3RA series

##### M12 Connector Models

- E3RA-T□21
- E3RA-R□21
- E3RA-D□2□

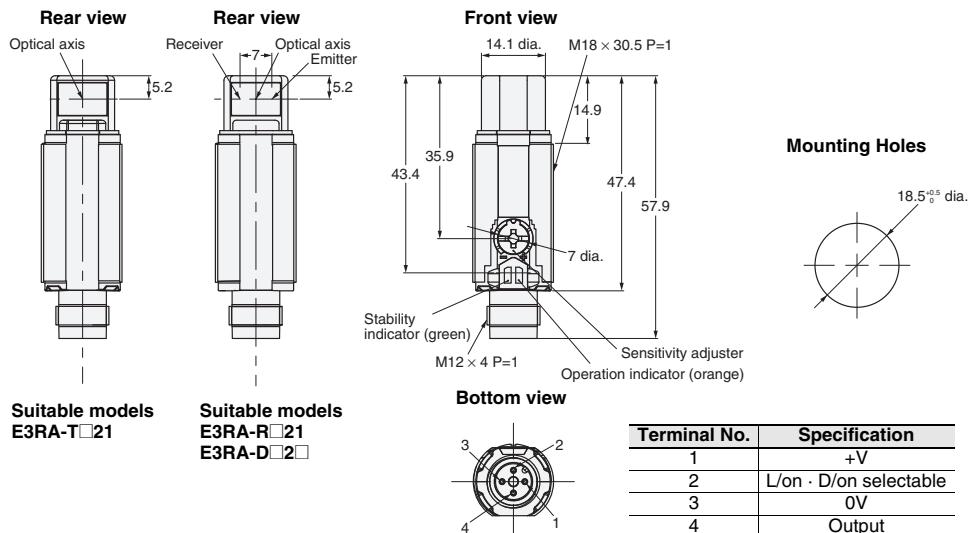

# E3FA/E3RA/E3FB/E3RB

## Sensors (E3FB/E3RB Metal housing)

### E3FB series

#### Pre-wired Models

- E3FB-T□11
- E3FB-R□1□
- E3FB-D□1□
- E3FB-L□1□
- E3FB-V□11
- E3FB-B□1□

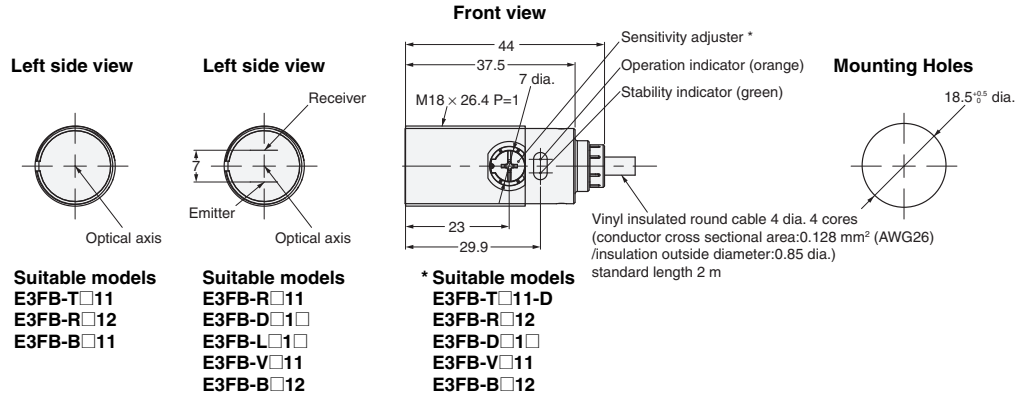

### E3FB series

#### M12 Connector Models

- E3FB-T□21
- E3FB-R□2□
- E3FB-D□2□
- E3FB-L□2□
- E3FB-V□21
- E3FB-B□2□

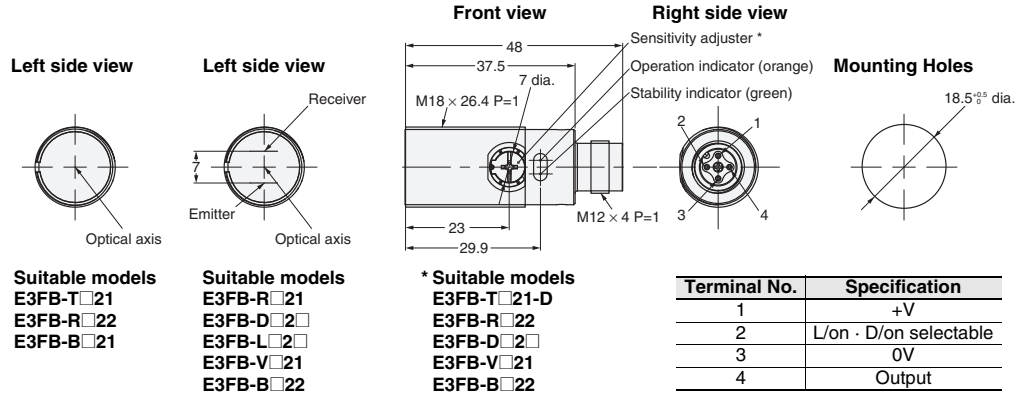

### E3RB series

#### Pre-wired Models

- E3RB-T□11
- E3RB-R□11
- E3RB-D□1□

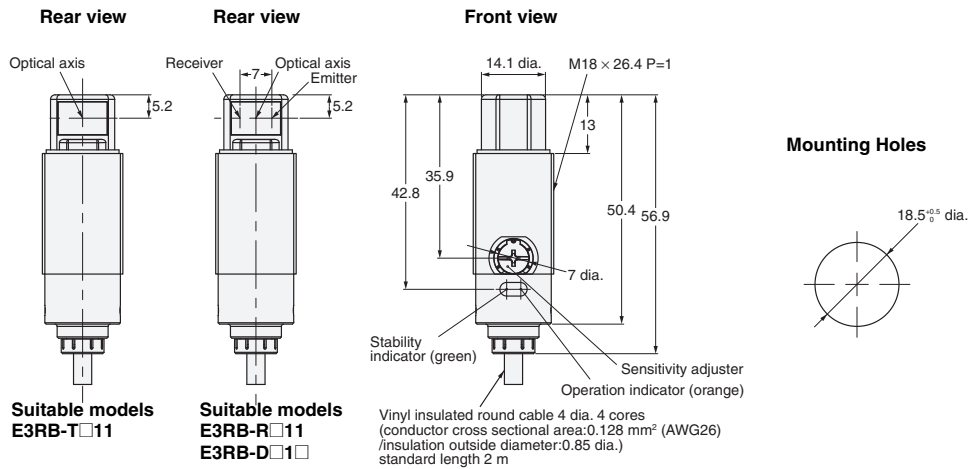

### E3RB series

#### M12 Connector Models

- E3RB-T□21
- E3RB-R□21
- E3RB-D□2□

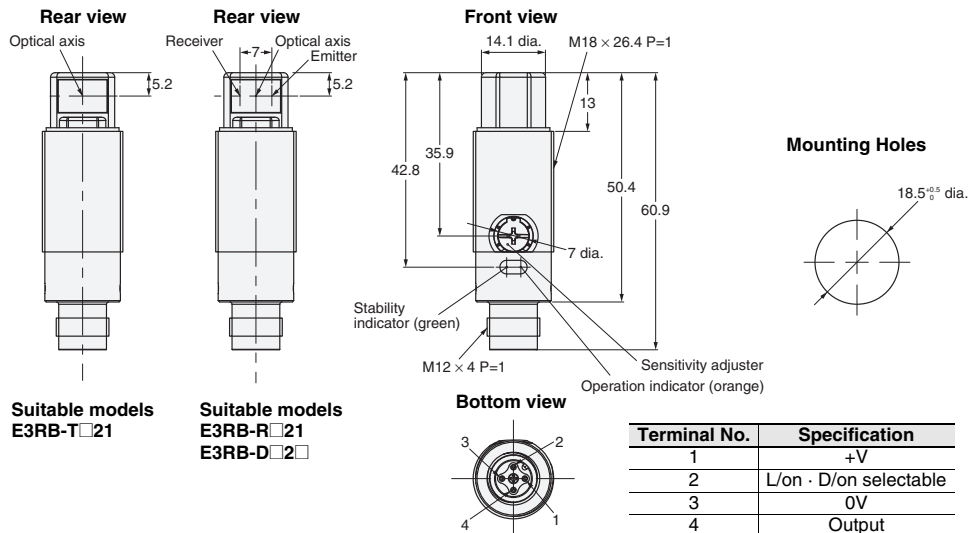

# E3FA/E3RA/E3FB/E3RB

## Attached nut

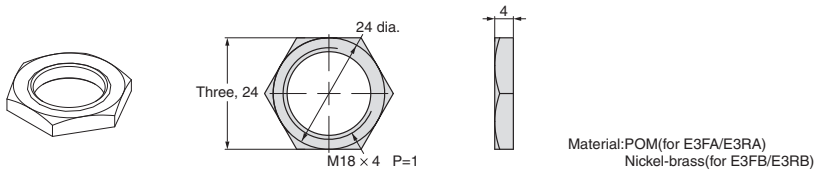

## Accessories (Order Separately)

### Reflectors

#### E39-R1S

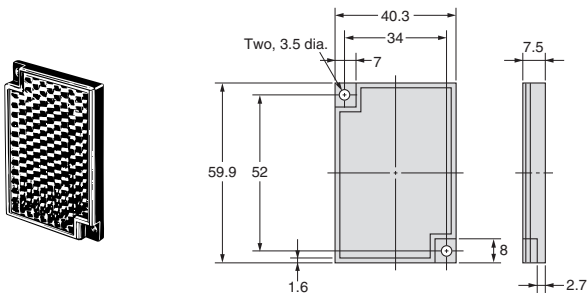

#### E39-RP1

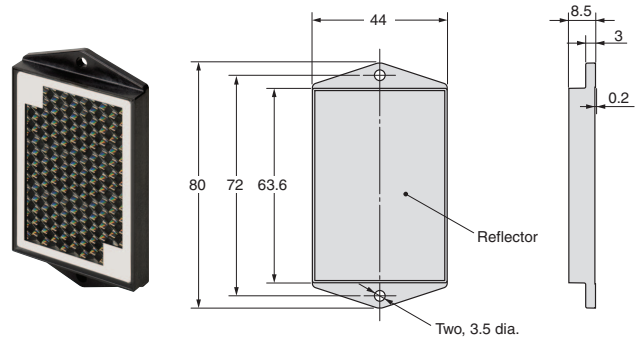

### Mounting brackets

#### E39-L183

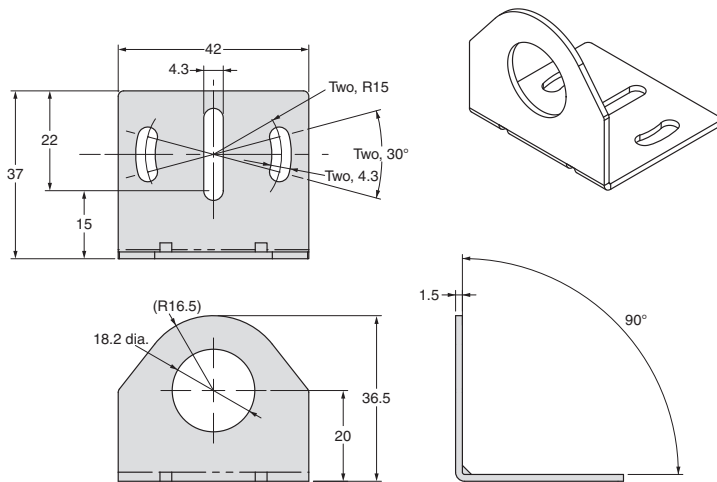

### Mounting brackets

#### E39-L182

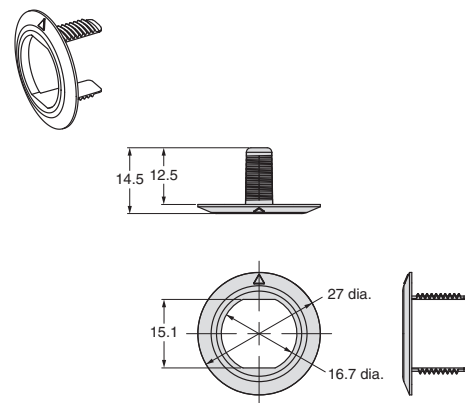

**ALL DIMENSIONS SHOWN ARE IN MILLIMETERS.**

To convert millimeters into inches, multiply by 0.03937. To convert grams into ounces, multiply by 0.03527.

# Terms and Conditions of Sale

1. **Offer; Acceptance.** These terms and conditions (these "**Terms**") are deemed part of all quotes, agreements, purchase orders, acknowledgments, price lists, catalogs, manuals, brochures and other documents, whether electronic or in writing, relating to the sale of products or services (collectively, the "**Products**") by Omron Electronics LLC and its subsidiary companies ("**Omron**"). Omron objects to any terms or conditions proposed in Buyer's purchase order or other documents which are inconsistent with, or in addition to, these Terms.
2. **Prices; Payment Terms.** All prices stated are current, subject to change without notice by Omron. Omron reserves the right to increase or decrease prices on any unshipped portions of outstanding orders. Payments for Products are due net 30 days unless otherwise stated in the invoice.
3. **Discounts.** Cash discounts, if any, will apply only on the net amount of invoices sent to Buyer after deducting transportation charges, taxes and duties, and will be allowed only if (i) the invoice is paid according to Omron's payment terms and (ii) Buyer has no past due amounts.
4. **Interest.** Omron, at its option, may charge Buyer 1-1/2% interest per month or the maximum legal rate, whichever is less, on any balance not paid within the stated terms.
5. **Orders.** Omron will accept no order less than \$200 net billing.
6. **Governmental Approvals.** Buyer shall be responsible for, and shall bear all costs involved in, obtaining any government approvals required for the importation or sale of the Products.
7. **Taxes.** All taxes, duties and other governmental charges (other than general real property and income taxes), including any interest or penalties thereon, imposed directly or indirectly on Omron or required to be collected directly or indirectly by Omron for the manufacture, production, sale, delivery, importation, consumption or use of the Products sold hereunder (including customs duties and sales, excise, use, turnover and license taxes) shall be charged to and remitted by Buyer to Omron.
8. **Financial.** If the financial position of Buyer at any time becomes unsatisfactory to Omron, Omron reserves the right to stop shipments or require satisfactory security or payment in advance. If Buyer fails to make payment or otherwise comply with these Terms or any related agreement, Omron may (without liability and in addition to other remedies) cancel any unshipped portion of Products sold hereunder and stop any Products in transit until Buyer pays all amounts, including amounts payable hereunder, whether or not then due, which are owing to it by Buyer. Buyer shall in any event remain liable for all unpaid accounts.
9. **Cancellation; Etc.** Orders are not subject to rescheduling or cancellation unless Buyer indemnifies Omron against all related costs or expenses.
10. **Force Majeure.** Omron shall not be liable for any delay or failure in delivery resulting from causes beyond its control, including earthquakes, fires, floods, strikes or other labor disputes, shortage of labor or materials, accidents to machinery, acts of sabotage, riots, delay in or lack of transportation or the requirements of any government authority.
11. **Shipping; Delivery.** Unless otherwise expressly agreed in writing by Omron:
  - a. Shipments shall be by a carrier selected by Omron; Omron will not drop ship except in "break down" situations.
  - b. Such carrier shall act as the agent of Buyer and delivery to such carrier shall constitute delivery to Buyer;
  - c. All sales and shipments of Products shall be FOB shipping point (unless otherwise stated in writing by Omron), at which point title and risk of loss shall pass from Omron to Buyer; provided that Omron shall retain a security interest in the Products until the full purchase price is paid;
  - d. Delivery and shipping dates are estimates only; and
  - e. Omron will package Products as it deems proper for protection against normal handling and extra charges apply to special conditions.
12. **Claims.** Any claim by Buyer against Omron for shortage or damage to the Products occurring before delivery to the carrier must be presented in writing to Omron within 30 days of receipt of shipment and include the original transportation bill signed by the carrier noting that the carrier received the Products from Omron in the condition claimed.
13. **Warranties.** (a) **Exclusive Warranty.** Omron's exclusive warranty is that the Products will be free from defects in materials and workmanship for a period of twelve months from the date of sale by Omron (or such other period expressed in writing by Omron). Omron disclaims all other warranties, express or implied. (b) **Limitations.** OMRON MAKES NO WARRANTY OR REPRESENTATION, EXPRESS OR IMPLIED, ABOUT NON-INFRINGEMENT, MERCHANTABILITY OR FITNESS FOR A PARTICULAR PURPOSE OF THE PRODUCTS. BUYER ACKNOWLEDGES THAT IT ALONE HAS DETERMINED THAT THE PRODUCTS WILL SUITABLY MEET THE REQUIREMENTS OF THEIR INTENDED USE. Omron further disclaims all warranties and responsibility of any type for claims or expenses based on infringement by the Products or otherwise of any intellectual property right. (c) **Buyer Remedy.** Omron's sole obligation hereunder shall be, at Omron's election, to (i) replace (in the form originally shipped with Buyer responsible for labor charges for removal or replacement thereof) the non-complying Product, (ii) repair the non-complying Product, or (iii) repay or credit Buyer an amount equal to the purchase price of the non-complying Product; provided that in no event shall Omron be responsible for warranty, repair, indemnity or any other claims or expenses regarding the Products unless Omron's analysis confirms that the Products were properly handled, stored, installed and maintained and not subject to contamination, abuse, misuse or inappropriate modification. Return of any Products by Buyer must be approved in writing by Omron before shipment. Omron Companies shall not be liable for the suitability or unsuitability or the results from the use of Products in combination with any electrical or electronic components, circuits, system assemblies or any other materials or substances or environments. Any advice, recommendations or information given orally or in writing, are not to be construed as an amendment or addition to the above warranty. See <http://www.omron247.com> or contact your Omron representative for published information.
14. **Limitation on Liability; Etc.** OMRON COMPANIES SHALL NOT BE LIABLE FOR SPECIAL, INDIRECT, INCIDENTAL, OR CONSEQUENTIAL DAMAGES, LOSS OF PROFITS OR PRODUCTION OR COMMERCIAL LOSS IN ANY WAY CONNECTED WITH THE PRODUCTS, WHETHER SUCH CLAIM IS BASED IN CONTRACT, WARRANTY, NEGLIGENCE OR STRICT LIABILITY. Further, in no event shall liability of Omron Companies exceed the individual price of the Product on which liability is asserted.
15. **Indemnities.** Buyer shall indemnify and hold harmless Omron Companies and their employees from and against all liabilities, losses, claims, costs and expenses (including attorney's fees and expenses) related to any claim, investigation, litigation or proceeding (whether or not Omron is a party) which arises or is alleged to arise from Buyer's acts or omissions under these Terms or in any way with respect to the Products. Without limiting the foregoing, Buyer (at its own expense) shall indemnify and hold harmless Omron and defend or settle any action brought against such Companies to the extent based on a claim that any Product made to Buyer specifications infringed intellectual property rights of another party.
16. **Property; Confidentiality.** Any intellectual property in the Products is the exclusive property of Omron Companies and Buyer shall not attempt to duplicate it in any way without the written permission of Omron. Notwithstanding any charges to Buyer for engineering or tooling, all engineering and tooling shall remain the exclusive property of Omron. All information and materials supplied by Omron to Buyer relating to the Products are confidential and proprietary, and Buyer shall limit distribution thereof to its trusted employees and strictly prevent disclosure to any third party.
17. **Export Controls.** Buyer shall comply with all applicable laws, regulations and licenses regarding (i) export of products or information; (ii) sale of products to "forbidden" or other proscribed persons; and (iii) disclosure to non-citizens of regulated technology or information.
18. **Miscellaneous.** (a) **Waiver.** No failure or delay by Omron in exercising any right and no course of dealing between Buyer and Omron shall operate as a waiver of rights by Omron. (b) **Assignment.** Buyer may not assign its rights hereunder without Omron's written consent. (c) **Law.** These Terms are governed by the law of the jurisdiction of the home office of the Omron company from which Buyer is purchasing the Products (without regard to conflict of law principles). (d) **Amendment.** These Terms constitute the entire agreement between Buyer and Omron relating to the Products, and no provision may be changed or waived unless in writing signed by the parties. (e) **Severability.** If any provision hereof is rendered ineffective or invalid, such provision shall not invalidate any other provision. (f) **Setoff.** Buyer shall have no right to set off any amounts against the amount owing in respect of this invoice. (g) **Definitions.** As used herein, "including" means "including without limitation"; and "Omron Companies" (or similar words) mean Omron Corporation and any direct or indirect subsidiary or affiliate thereof.

## Certain Precautions on Specifications and Use

1. **Suitability of Use.** Omron Companies shall not be responsible for conformity with any standards, codes or regulations which apply to the combination of the Product in the Buyer's application or use of the Product. At Buyer's request, Omron will provide applicable third party certification documents identifying ratings and limitations of use which apply to the Product. This information by itself is not sufficient for a complete determination of the suitability of the Product in combination with the end product, machine, system, or other application or use. Buyer shall be solely responsible for determining appropriateness of the particular Product with respect to Buyer's application, product or system. Buyer shall take application responsibility in all cases but the following is a non-exhaustive list of applications for which particular attention must be given: (i) Outdoor use, uses involving potential chemical contamination or electrical interference, or conditions or uses not described in this document. (ii) Use in consumer products or any use in significant quantities. (iii) Energy control systems, combustion systems, railroad systems, aviation systems, medical equipment, amusement machines, vehicles, safety equipment, and installations subject to separate industry or government regulations. (iv) Systems, machines and equipment that could present a risk to life or property. Please know and observe all prohibitions of use applicable to this Product. NEVER USE THE PRODUCT FOR AN APPLICATION INVOLVING SERIOUS RISK TO LIFE OR PROPERTY OR IN LARGE QUANTITIES WITHOUT ENSURING THAT THE SYSTEM AS A WHOLE HAS BEEN DESIGNED TO ADDRESS THE RISKS, AND THAT THE OMRON'S PRODUCT IS PROPERLY RATED AND INSTALLED FOR THE INTENDED USE WITHIN THE OVERALL EQUIPMENT OR SYSTEM.
2. **Programmable Products.** Omron Companies shall not be responsible for the user's programming of a programmable Product, or any consequence thereof.
3. **Performance Data.** Data presented in Omron Company websites, catalogs and other materials is provided as a guide for the user in determining suitability and does not constitute a warranty. It may represent the result of Omron's test conditions, and the user must correlate it to actual application requirements. Actual performance is subject to the Omron's Warranty and Limitations of Liability.
4. **Change in Specifications.** Product specifications and accessories may be changed at any time based on improvements and other reasons. It is our practice to change part numbers when published ratings or features are changed, or when significant construction changes are made. However, some specifications of the Product may be changed without any notice. When in doubt, special part numbers may be assigned to fix or establish key specifications for your application. Please consult with your Omron's representative at any time to confirm actual specifications of purchased Product.
5. **Errors and Omissions.** Information presented by Omron Companies has been checked and is believed to be accurate; however, no responsibility is assumed for clerical, typographical or proofreading errors or omissions.

**OMRON AUTOMATION AND SAFETY • THE AMERICAS HEADQUARTERS** • Hoffman Estates, IL USA • 847.843.7900 • 800.556.6766 • [www.omron247.com](http://www.omron247.com)

**OMRON CANADA, INC. • HEAD OFFICE**

Toronto, ON, Canada • 416.286.6465 • 866.986.6766 • [www.omron247.com](http://www.omron247.com)

**OMRON ELECTRONICS DE MEXICO • HEAD OFFICE**

México DF • 52.55.59.01.43.00 • 01-800-226-6766 • [mela@omron.com](mailto:mela@omron.com)

**OMRON ELECTRONICS DE MEXICO • SALES OFFICE**

Apodaca, N.L. • 52.81.11.56.99.20 • 01-800-226-6766 • [mela@omron.com](mailto:mela@omron.com)

**OMRON ELETRÔNICA DO BRASIL LTDA • HEAD OFFICE**

São Paulo, SP, Brasil • 55.11.2101.6300 • [www.omron.com.br](http://www.omron.com.br)

**OMRON ARGENTINA • SALES OFFICE**

Cono Sur • 54.11.4783.5300

**OMRON CHILE • SALES OFFICE**

Santiago • 56.9.9917.3920

**OTHER OMRON LATIN AMERICA SALES**

54.11.4783.5300

**OMRON EUROPE B.V.** • Wegalaan 67-69, NL-2132 JD, Hoofddorp, The Netherlands. • +31 (0) 23 568 13 00 • [www.industrial.omron.eu](http://www.industrial.omron.eu)

*Authorized Distributor:*

**Automation Control Systems**

- Machine Automation Controllers (MAC) • Programmable Controllers (PLC)
- Operator interfaces (HMI) • Distributed I/O • Software

**Drives & Motion Controls**

- Servo & AC Drives • Motion Controllers & Encoders

**Temperature & Process Controllers**

- Single and Multi-loop Controllers

**Sensors & Vision**

- Proximity Sensors • Photoelectric Sensors • Fiber-Optic Sensors
- Amplified Photomicrosensors • Measurement Sensors
- Ultrasonic Sensors • Vision Sensors

**Industrial Components**



- RFID/Code Readers • Relays • Pushbuttons & Indicators
- Limit and Basic Switches • Timers • Counters • Metering Devices
- Power Supplies

**Safety**





- Laser Scanners • Safety Mats • Edges and Bumpers • Programmable Safety Controllers • Light Curtains • Safety Relays • Safety Interlock Switches

## Looking for pricing, stock, or lifecycle information?

Click below to explore more details on WIN SOURCE:

-  [View E3FB-TP11 2M on WIN SOURCE](#)
-  [Omron Information](#)

## Optimize Your Supply Chain with WIN SOURCE Solutions

-  Global Sourcing Solution
-  Obsolete Management
-  Cost Control Management
-  Shortage Management
-  Alternative Solution
-  Excess Inventory Management