



**THE DATASHEET OF  
ISL78302AARJCZ**



ISL78302A

Dual LDO with Low Noise, Very High PSRR and Low IQ

FN7932  
Rev 2.00  
December 22, 2015

**ISL78302A** is a high-performance dual LDO capable of sourcing 300mA current from each output. It has a low standby current and very high PSRR and is stable with output capacitance of 1µF to 10µF with ESR of up to 200mΩ.

The device integrates an individual Power-On Reset (POR) function for each output. The POR delay for VO2 can be externally programmed by connecting a timing capacitor to the CPOR pin. The POR delay for VO1 is internally fixed at approximately 2ms. A reference bypass pin is also provided for connecting a noise-filtering capacitor for low noise and high-PSRR applications.

The quiescent current is typically only 47µA with both LDOs enabled and active. Separate Enable pins control each individual LDO output. When both Enable pins are low, the device is in shutdown, typically drawing less than 0.3µA.

The ISL78302A is AEC-Q100 qualified. The ISL78302A is rated for the automotive temperature range (-40°C to +105°C).

**Features**

- Integrates Two 300mA High-performance LDOs
- Excellent Transient Response to Large Current Steps
- ±1.8% Accuracy Over All Operating Conditions
- Excellent Load Regulation: < 0.1% Voltage Change Across Full Range of Load Current
- Low Output Noise: Typically 30µV<sub>RMS</sub> at 100µA (1.5V)
- Very High PSRR: 90dB at 1kHz
- Extremely Low Quiescent Current: 47µA (Both LDOs Active)
- Wide Input Voltage Capability: 2.3V to 6.5V
- Low Dropout Voltage: Typically 230mV at 300mA
- Stable with 1µF to 10µF Ceramic Capacitors
- Separate Enable and POR Pins for Each LDO
- Soft-start and Staged Turn-on to Limit Input Current Surge During Enable
- Current Limit and Overheat Protection
- Tiny 10 Ld 3mmx3mm DFN Package
- -40°C to +105°C Operating Temperature Range
- Pb-free (RoHS Compliant)
- AEC-Q100 Qualified

**Applications**

- Radio Receivers
- Camera Modules
- GPS/Navigation
- Infotainment Systems

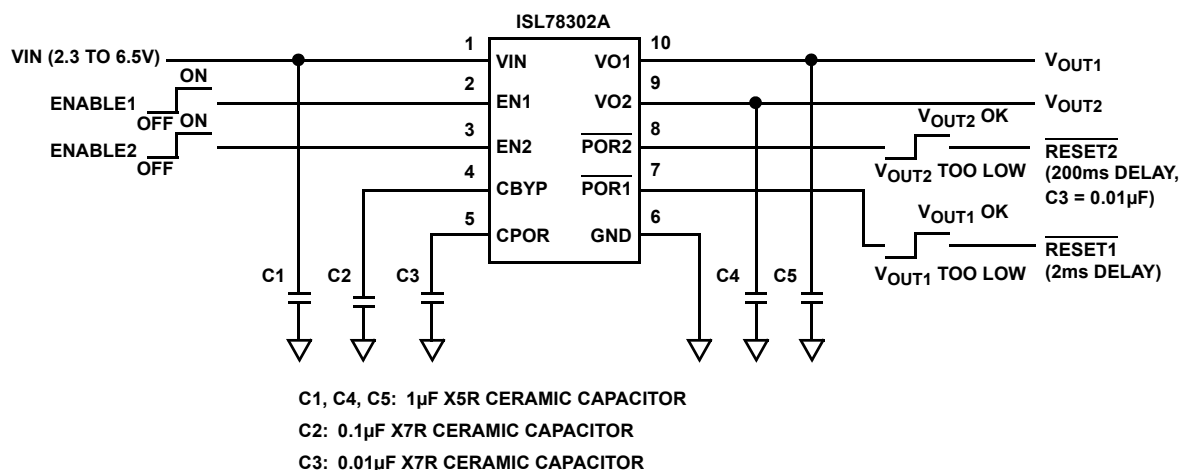
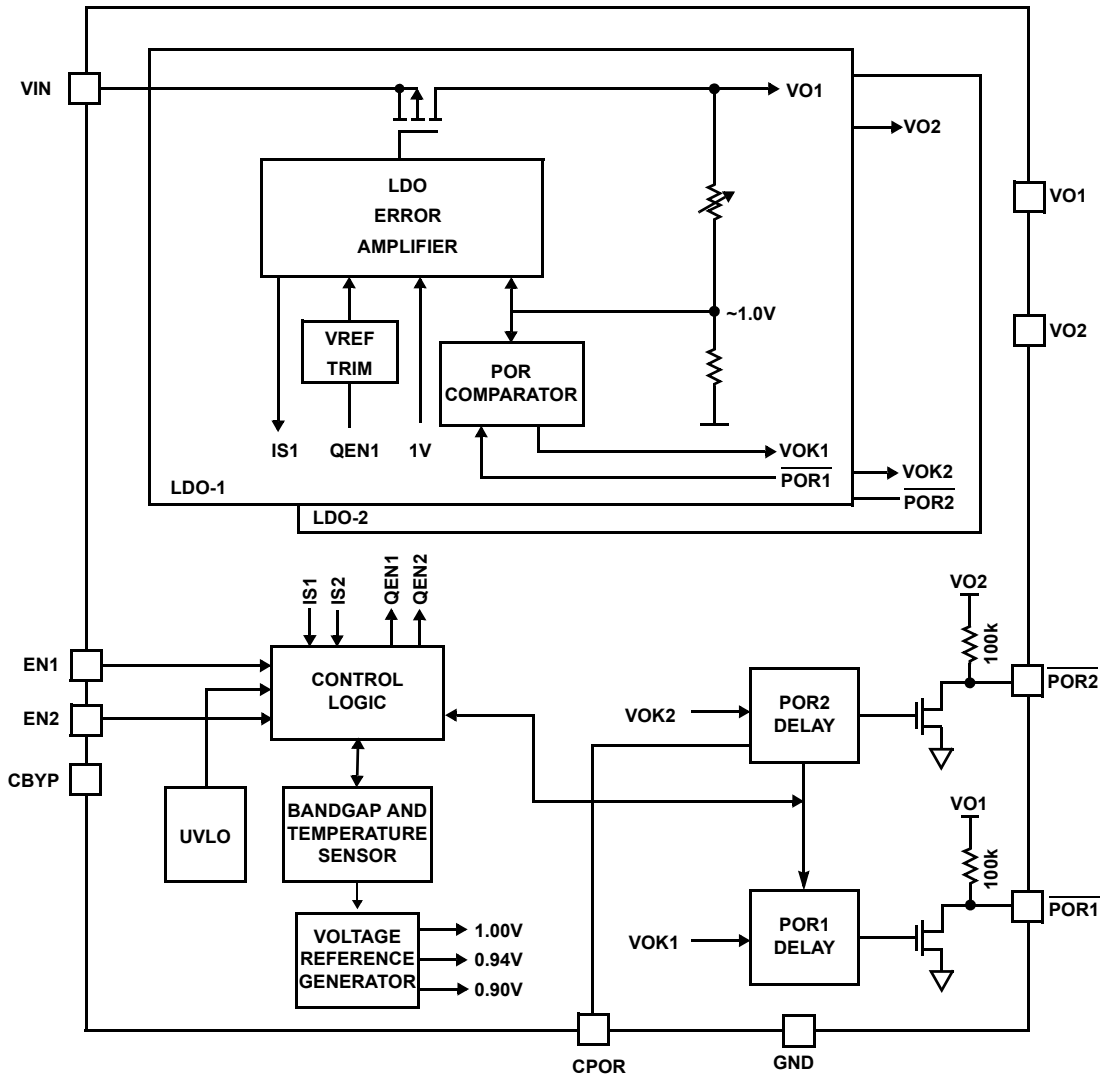
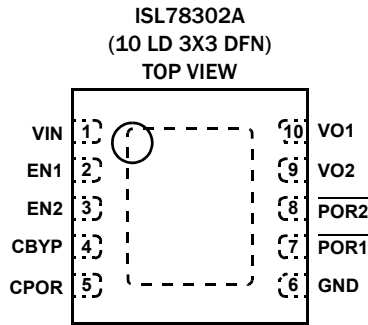

FIGURE 1. TYPICAL APPLICATION

# Block Diagram



## Pin Configuration



## Pin Descriptions

| PIN NUMBER | PIN NAME                 | TYPE                              | DESCRIPTION   |
|------------|--------------------------|-----------------------------------|---|
| 1          | VIN                      | Analog I/O                        | Supply Voltage/LDO Input. Connect a 1 $\mu$ F capacitor to GND.   |
| 2          | EN1                      | Low Voltage Compatible CMOS Input | LDO-1 Enable  |
| 3          | EN2                      | Low Voltage Compatible CMOS Input | LDO-2 Enable  |
| 4          | CBYP                     | Analog I/O                        | Reference Bypass Capacitor Pin. Optionally connect capacitor of value 0.01 $\mu$ F to 1 $\mu$ F between this pin and GND to tune in the desired noise and PSRR performance.   |
| 5          | CPOR                     | Analog I/O                        | POR2 Delay Setting Capacitor Pin. Connect a capacitor between this pin and GND to delay the $\overline{\text{POR2}}$ output release after LDO-2 output reaches 94% of its specified voltage level (200ms delay per 0.01 $\mu$ F). |
| 6          | GND                      | Ground                            | Connection to system ground. Connect to PCB Ground plane.   |
| 7          | $\overline{\text{POR1}}$ | Open Drain Output (1mA)           | Open-drain POR Output for LDO-1 (active-low). Internally connected to VO1 through 100k $\Omega$ resistor.   |
| 8          | $\overline{\text{POR2}}$ | Open Drain Output (1mA)           | Open-drain POR Output for LDO-2 (active-low). Internally connected to VO2 through 100k $\Omega$ resistor.   |
| 9          | VO2                      | Analog I/O                        | LDO-2 Output. Connect capacitor of value 1 $\mu$ F to 10 $\mu$ F to GND (1 $\mu$ F recommended).  |
| 10         | VO1                      | Analog I/O                        | LDO-1 Output. Connect capacitor of value 1 $\mu$ F to 10 $\mu$ F to GND (1 $\mu$ F recommended).  |

## Ordering Information

| PART NUMBER<br>(Notes 1, 2, 3) | PART MARKING | VO1 VOLTAGE (V) | VO2 VOLTAGE (V) | TEMP RANGE (°C) | PACKAGE (RoHS Compliant) | PKG DWG. # |
|--------------------------------|--------------|-----------------|-----------------|-----------------|--------------------------|------------|
| ISL78302AARMMZ                 | DNAL         | 3.0             | 3.0             | -40 to +105     | 10 Ld 3x3 DFN            | L10.3x3C   |
| ISL78302AARLLZ                 | DNAM         | 2.9             | 2.9             | -40 to +105     | 10 Ld 3x3 DFN            | L10.3x3C   |
| ISL78302AARJMZ                 | DNAN         | 2.8             | 3.0             | -40 to +105     | 10 Ld 3x3 DFN            | L10.3x3C   |
| ISL78302AARJRZ                 | DNAP         | 2.8             | 2.6             | -40 to +105     | 10 Ld 3x3 DFN            | L10.3x3C   |
| ISL78302AARJCZ                 | DNAK         | 2.8             | 1.8             | -40 to +105     | 10 Ld 3x3 DFN            | L10.3x3C   |
| ISL78302AARGCZ                 | DNAR         | 2.7             | 1.8             | -40 to +105     | 10 Ld 3x3 DFN            | L10.3x3C   |
| ISL78302AARPLZ                 | DNAS         | 1.85            | 2.9             | -40 to +105     | 10 Ld 3x3 DFN            | L10.3x3C   |
| ISL78302AARBJZ                 | DNAT         | 1.5             | 2.8             | -40 to +105     | 10 Ld 3x3 DFN            | L10.3x3C   |

### NOTES:

- Add "-T" suffix for tape and reel. Please refer to [TB347](#) for details on reel specifications.
- These Intersil Pb-free plastic packaged products employ special Pb-free material sets, molding compounds/die attach materials, and 100% matte tin plate plus anneal (e3 termination finish, which is RoHS compliant and compatible with both SnPb and Pb-free soldering operations). Intersil Pb-free products are MSL classified at Pb-free peak reflow temperatures that meet or exceed the Pb-free requirements of IPC/JEDEC J STD-020.
- For Moisture Sensitivity Level (MSL), please see device information page for [ISL78302A](#). For more information on MSL, please see Tech Brief [TB363](#).

## Absolute Maximum Ratings

|                             |                             |
|-----------------------------|-----------------------------|
| Supply Voltage ( $V_{IN}$ ) | +7.1V                       |
| $V_{O1}$ , $V_{O2}$ Pins    | +3.6V                       |
| All Other Pins              | -0.3 to ( $V_{IN} + 0.3$ )V |

## ESD Ratings

|   |       |
|---|-------|
| Human Body Model (Tested per JESD22-A114E)    | 3000V |
| Machine Model (Tested per JESD-A115-A)        | 200V  |
| Charge Device Model (Tested per AEC-Q100-011) | 1500V |

## Thermal Information

|                                    |   |   |
|------------------------------------|---|---|
| Thermal Resistance                 | $\theta_{JA}$ ( $^{\circ}\text{C}/\text{W}$ )     | $\theta_{JC}$ ( $^{\circ}\text{C}/\text{W}$ ) |
| 10 Ld 3x3 DFN Package (Notes 4, 5) | 59  | 18.5  |
| Junction Temperature Range         | -40 $^{\circ}\text{C}$ to +125 $^{\circ}\text{C}$ |   |
| Storage Temperature Range          | -65 $^{\circ}\text{C}$ to +150 $^{\circ}\text{C}$ |   |
| Pb-free Reflow Profile             | see <a href="#">TB493</a>                         |   |

## Recommended Operating Conditions

|                                     |   |
|-------------------------------------|---|
| Ambient Temperature Range ( $T_A$ ) | -40 $^{\circ}\text{C}$ to +105 $^{\circ}\text{C}$ |
| Operating Temperature Range         | -40 $^{\circ}\text{C}$ to +105 $^{\circ}\text{C}$ |
| Supply Voltage ( $V_{IN}$ )         | 2.3V to 6.5V                                      |

**CAUTION:** Do not operate at or near the maximum ratings listed for extended periods of time. Exposure to such conditions may adversely impact product reliability and result in failures not covered by warranty.

### NOTES:

- $\theta_{JA}$  is measured in free air with the component mounted on a high effective thermal conductivity test board with “direct attach” features. See Tech Brief [TB379](#).
- For  $\theta_{JC}$ , the “case temp” location is the center of the exposed metal pad on the package underside.

## Electrical Specifications

Unless otherwise noted, all parameters are guaranteed over the operational supply voltage and temperature range of the device as follows:  $T_A = -40^{\circ}\text{C}$  to  $105^{\circ}\text{C}$ ;  $V_{IN} = (V_O + 0.5\text{V})$  to 6.5V with a minimum  $V_{IN}$  of 2.3V;  $C_{IN} = 1\mu\text{F}$ ;  $C_O = 1\mu\text{F}$ ;  $C_{BYP} = 0.01\mu\text{F}$ ;  $C_{POR} = 0.01\mu\text{F}$ . **Boldface limits apply over the operating temperature range, -40 $^{\circ}\text{C}$  to +105 $^{\circ}\text{C}$ .**

| PARAMETER                    | SYMBOL    | TEST CONDITIONS  | MIN<br>(Note 6) | TYP | MAX<br>(Note 6) | UNITS              |    |
|------------------------------|-----------|--|-----------------|-----|-----------------|--------------------|----|
| <b>DC CHARACTERISTICS</b>    |           |  |                 |     |                 |                    |    |
| Supply Voltage               | $V_{IN}$  |  | <b>2.3</b>      |     | <b>6.5</b>      | V                  |    |
| Ground Current               |           | Quiescent condition: $I_{O1} = 0\mu\text{A}$ ; $I_{O2} = 0\mu\text{A}$   |                 |     |                 |                    |    |
|                              | $I_{DD1}$ | One LDO active   |                 | 30  | <b>36</b>       | $\mu\text{A}$      |    |
|                              | $I_{DD2}$ | Both LDO active  |                 | 47  | <b>55</b>       | $\mu\text{A}$      |    |
| Shutdown Current             | $I_{DDS}$ |  |                 | 0.3 | <b>2.1</b>      | $\mu\text{A}$      |    |
| UVLO Threshold               | $V_{UV+}$ |  | <b>1.9</b>      | 2.1 | <b>2.3</b>      | V                  |    |
|                              | $V_{UV-}$ |  | <b>1.6</b>      | 1.8 | <b>2.0</b>      | V                  |    |
| Regulation Voltage Accuracy  |           | $V_{IN} = V_O + 0.5\text{V}$ to 5.5V, $I_O = 10\mu\text{A}$ to 300mA, $T_J = +25^{\circ}\text{C}$                            | <b>-0.8</b>     |     | <b>+0.8</b>     | %                  |    |
|                              |           | $V_{IN} = V_O + 0.5\text{V}$ to 5.5V, $I_O = 10\mu\text{A}$ to 300mA, $T_J = -40^{\circ}\text{C}$ to +125 $^{\circ}\text{C}$ | <b>-1.8</b>     |     | <b>+1.8</b>     | %                  |    |
| Maximum Output Current       | $I_{MAX}$ | Continuous   | <b>300</b>      |     |                 | mA                 |    |
| Internal Current Limit       | $I_{LIM}$ |  | <b>320</b>      | 475 | <b>650</b>      | mA                 |    |
| Dropout Voltage (Note 7)     | $V_{D01}$ | $I_O = 300\text{mA}$ ; $V_O < 2.5\text{V}$   |                 | 450 |                 | mV                 |    |
|                              |           | $I_O = 150\text{mA}$ ; $V_O < 2.5\text{V}$   |                 | 225 | <b>250</b>      |                    |    |
|                              | $V_{D02}$ | $I_O = 300\text{mA}$ ; $2.5\text{V} \leq V_O \leq 2.8\text{V}$   |                 | 250 |                 |                    | mV |
|                              |           | $I_O = 150\text{mA}$ ; $2.5\text{V} \leq V_O \leq 2.8\text{V}$   |                 | 125 | <b>160</b>      |                    | mV |
|                              | $V_{D03}$ | $I_O = 300\text{mA}$ ; $V_O > 2.8\text{V}$   |                 | 230 |                 |                    | mV |
|                              |           | $I_O = 150\text{mA}$ ; $V_O > 2.8\text{V}$   |                 | 115 | <b>145</b>      |                    | mV |
| Thermal Shutdown Temperature | $T_{SD+}$ |  |                 | 145 |                 | $^{\circ}\text{C}$ |    |
|                              | $T_{SD-}$ |  |                 | 110 |                 | $^{\circ}\text{C}$ |    |
| <b>AC CHARACTERISTICS</b>    |           |  |                 |     |                 |                    |    |
| Ripple Rejection             |           | $I_O = 10\text{mA}$ , $V_{IN} = 2.8\text{V}(\text{min})$ , $V_O = 1.8\text{V}$ , $C_{BYP} = 0.1\mu\text{F}$                  |                 |     |                 |                    |    |
|                              |           | @ 1kHz   |                 | 90  |                 | dB                 |    |
|                              |           | @ 10kHz  |                 | 70  |                 | dB                 |    |
|                              |           | @ 100kHz   |                 | 50  |                 | dB                 |    |

**Electrical Specifications** Unless otherwise noted, all parameters are guaranteed over the operational supply voltage and temperature range of the device as follows:  $T_A = -40^\circ\text{C}$  to  $105^\circ\text{C}$ ;  $V_{IN} = (V_O + 0.5\text{V})$  to  $6.5\text{V}$  with a minimum  $V_{IN}$  of  $2.3\text{V}$ ;  $C_{IN} = 1\mu\text{F}$ ;  $C_O = 1\mu\text{F}$ ;  $C_{BYP} = 0.01\mu\text{F}$ ;  $C_{POR} = 0.01\mu\text{F}$ . **Boldface limits apply over the operating temperature range,  $-40^\circ\text{C}$  to  $+105^\circ\text{C}$ .** (Continued) (Continued)

| PARAMETER   | SYMBOL              | TEST CONDITIONS   | MIN (Note 6) | TYP | MAX (Note 6)   | UNITS                  |
|---|---------------------|---|--------------|-----|----------------|------------------------|
| Output Noise Voltage  |                     | $I_O = 100\mu\text{A}$ , $V_O = 1.5\text{V}$ , $T_A = +25^\circ\text{C}$ , $C_{BYP} = 0.1\mu\text{F}$<br>$\text{BW} = 10\text{Hz}$ to $100\text{kHz}$ |              | 30  |                | $\mu\text{VRMS}$       |
| <b>DEVICE START-UP CHARACTERISTICS</b>  |                     |   |              |     |                |                        |
| Device Enable Time  | $t_{EN}$            | Time from assertion of the ENx pin to when the output voltage reaches 95% of the $V_O$ (nom)  |              | 250 | <b>500</b>     | $\mu\text{s}$          |
| LDO Soft-Start Ramp Rate  | $t_{SSR}$           | Slope of linear portion of LDO output voltage ramp during start-up  |              | 30  | <b>60</b>      | $\mu\text{s}/\text{V}$ |
| <b>EN1, EN2 PIN CHARACTERISTICS</b>   |                     |   |              |     |                |                        |
| Input Low Voltage   | $V_{IL}$            |   | <b>-0.3</b>  |     | <b>0.5</b>     | V                      |
| Input High Voltage  | $V_{IH}$            |   | <b>1.35</b>  |     | $V_{IN} + 0.3$ | V                      |
| Input Leakage Current   | $I_{IL}$ , $I_{IH}$ |   |              |     | <b>0.1</b>     | $\mu\text{A}$          |
| Pin Capacitance   | $C_{PIN}$           | Informative   |              | 5   |                | pF                     |
| <b>POR1, POR2 PIN CHARACTERISTICS</b>   |                     |   |              |     |                |                        |
| $\overline{\text{POR1}}$ , $\overline{\text{POR2}}$ Thresholds                      | $V_{POR+}$          | As a percentage of nominal output voltage   | <b>91</b>    | 94  | <b>97</b>      | %                      |
|   | $V_{POR-}$          |   | <b>87</b>    | 90  | <b>93</b>      | %                      |
| $\overline{\text{POR1}}$ Delay  | $t_{P1LH}$          |   | <b>0.5</b>   | 2.0 | <b>3.2</b>     | ms                     |
|   | $t_{P1HL}$          |   |              | 25  |                | $\mu\text{s}$          |
| $\overline{\text{POR2}}$ Delay  | $t_{P2LH}$          | $C_{POR} = 0.01\mu\text{F}$   | <b>100</b>   | 200 | <b>300</b>     | ms                     |
|   | $t_{P2HL}$          |   |              | 25  |                | $\mu\text{s}$          |
| $\overline{\text{POR1}}$ , $\overline{\text{POR2}}$ Pin Output Low Voltage          | $V_{OL}$            | @ $I_{OL} = 1.0\text{mA}$   |              |     | <b>0.2</b>     | V                      |
| $\overline{\text{POR1}}$ , $\overline{\text{POR2}}$ Pin Internal Pull-Up Resistance | $R_{POR}$           |   | <b>78</b>    | 100 | <b>180</b>     | k $\Omega$             |

NOTES:

- Compliance to datasheet limits is assured by one or more methods: production test, characterization and/or design.
- $V_{OX} = 0.98 * V_{OX}(\text{NOM})$ ; valid for  $V_{OX}$  greater than  $1.85\text{V}$ .

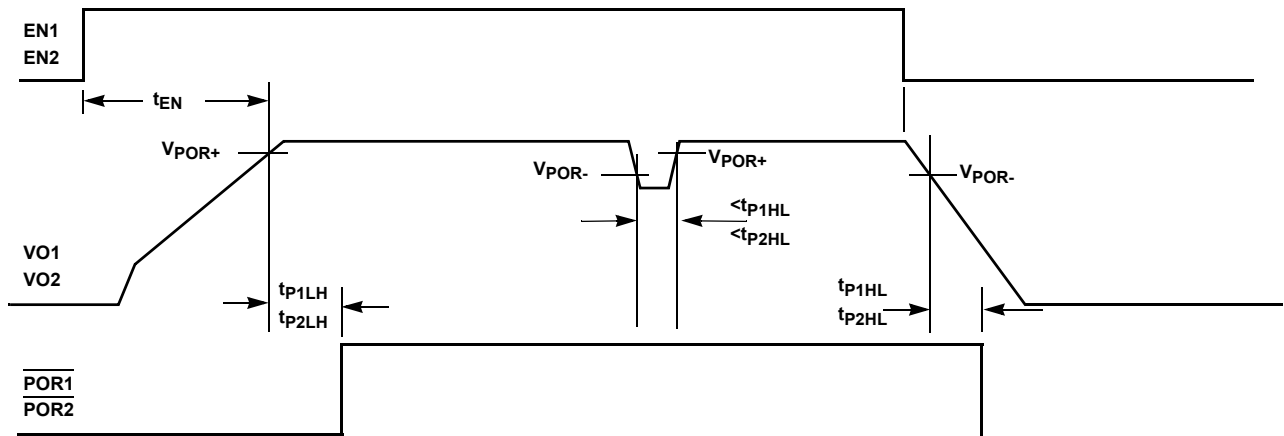

FIGURE 2. TIMING PARAMETER DEFINITION

# Typical Performance Curves

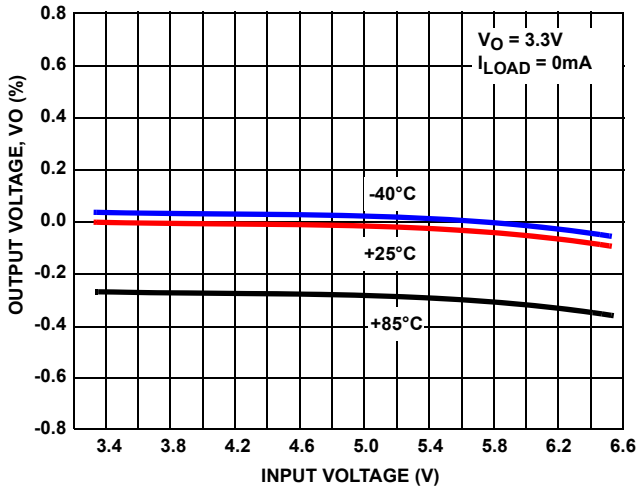

FIGURE 3. OUTPUT VOLTAGE vs INPUT VOLTAGE (3.3V OUTPUT)

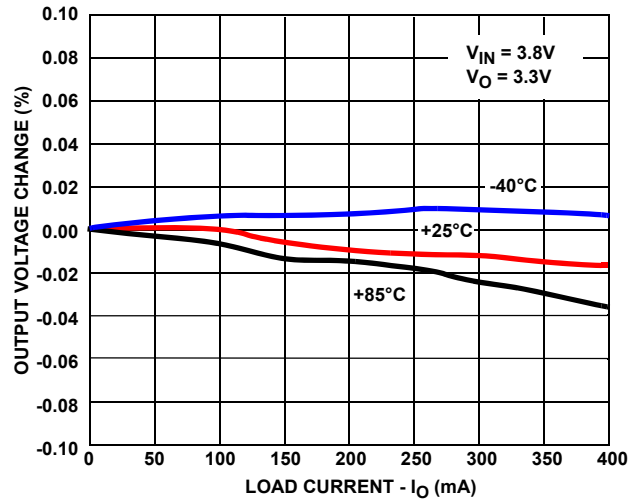

FIGURE 4. OUTPUT VOLTAGE CHANGE vs LOAD CURRENT

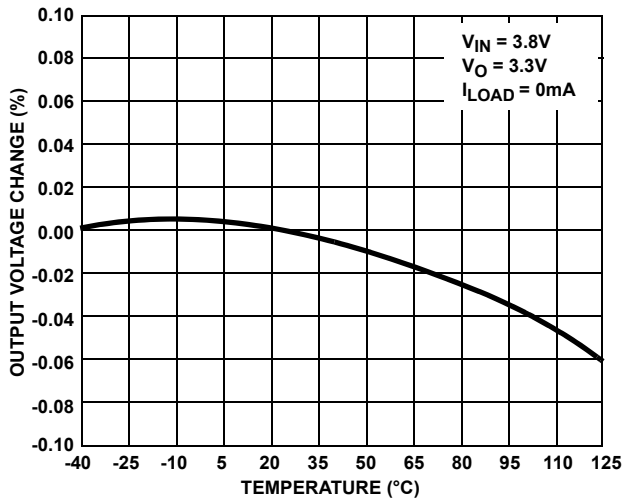

FIGURE 5. OUTPUT VOLTAGE CHANGE vs TEMPERATURE

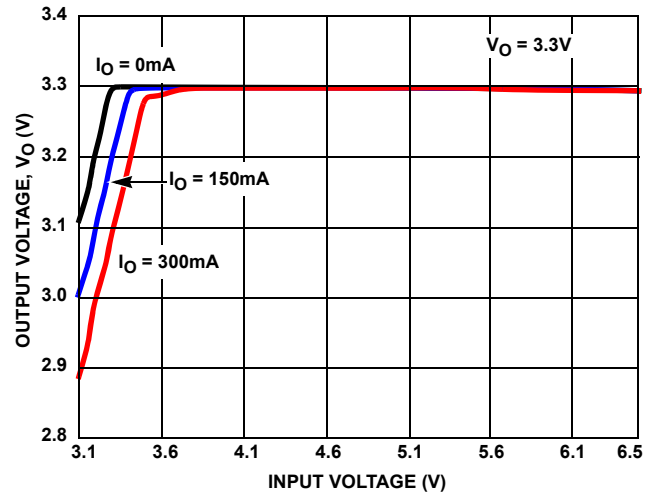

FIGURE 6. OUTPUT VOLTAGE vs INPUT VOLTAGE (3.3V OUTPUT)

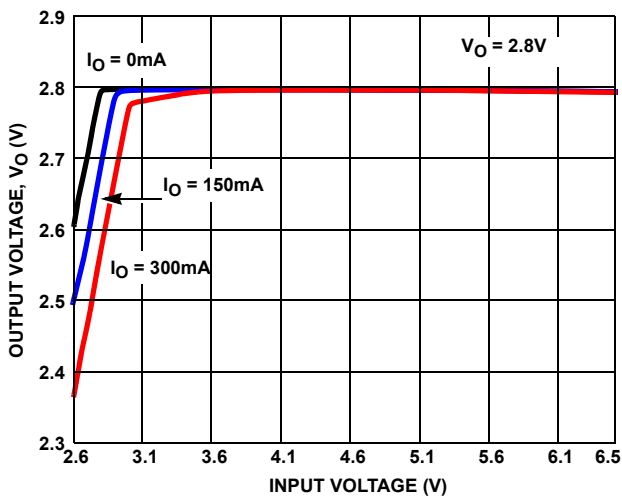

FIGURE 7. OUTPUT VOLTAGE vs INPUT VOLTAGE (2.8V OUTPUT)

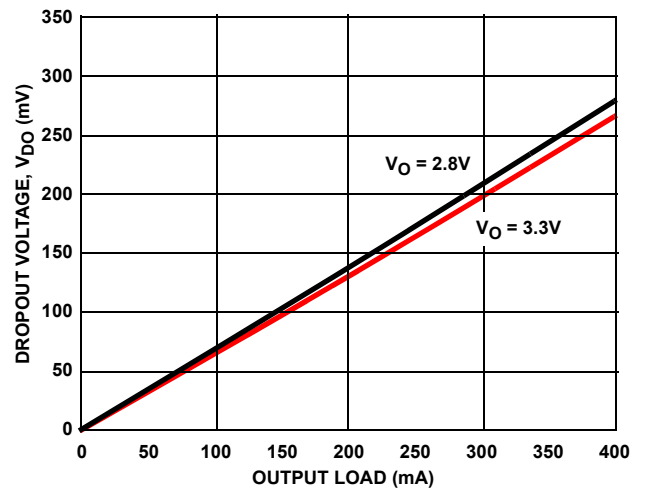

FIGURE 8. DROPOUT VOLTAGE vs LOAD CURRENT

## Typical Performance Curves (Continued)

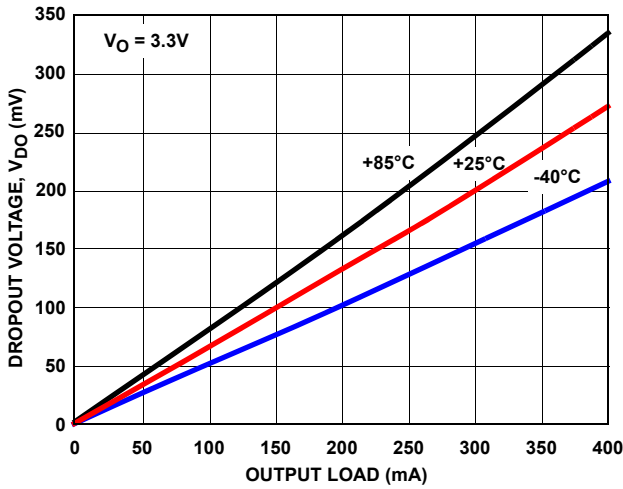

FIGURE 9. DROPOUT VOLTAGE vs LOAD CURRENT

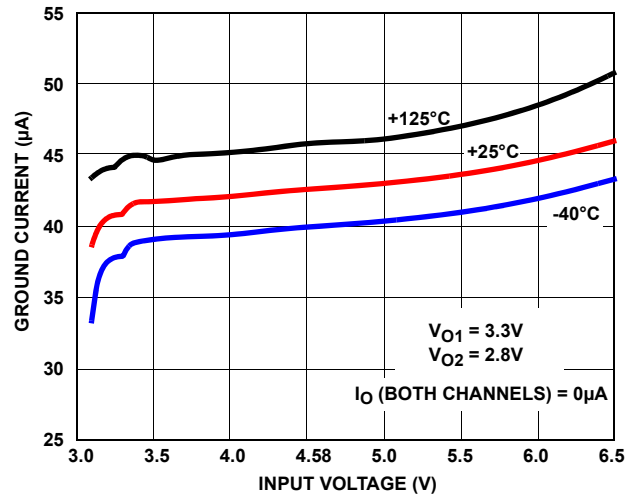

FIGURE 10. GROUND CURRENT vs INPUT VOLTAGE

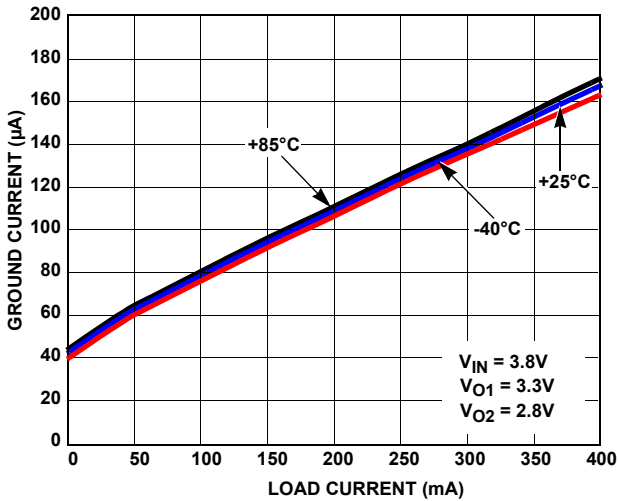

FIGURE 11. GROUND CURRENT vs LOAD

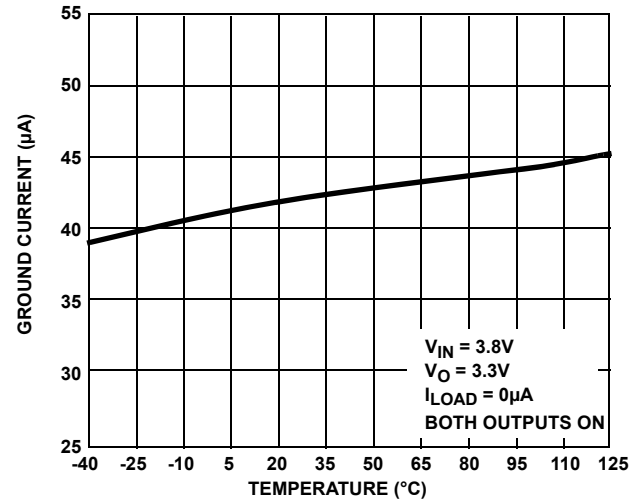

FIGURE 12. GROUND CURRENT vs TEMPERATURE

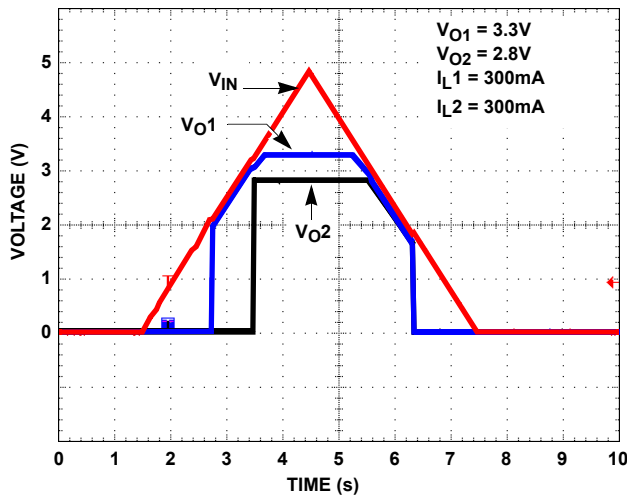

FIGURE 13. POWER-UP/POWER-DOWN

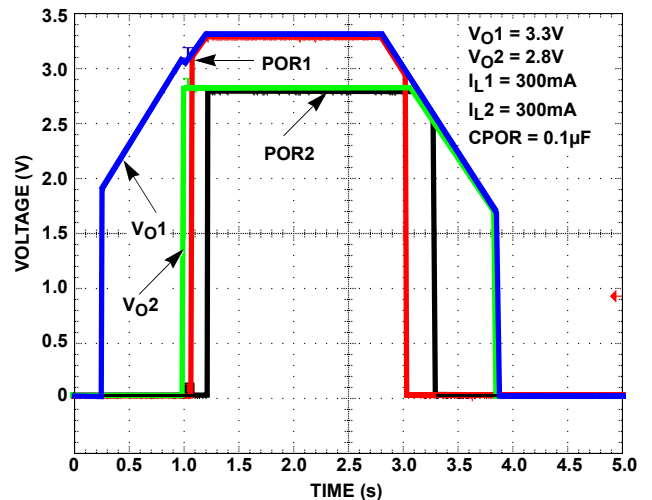

FIGURE 14. POWER-UP/POWER-DOWN WITH POR SIGNALS

## Typical Performance Curves (Continued)

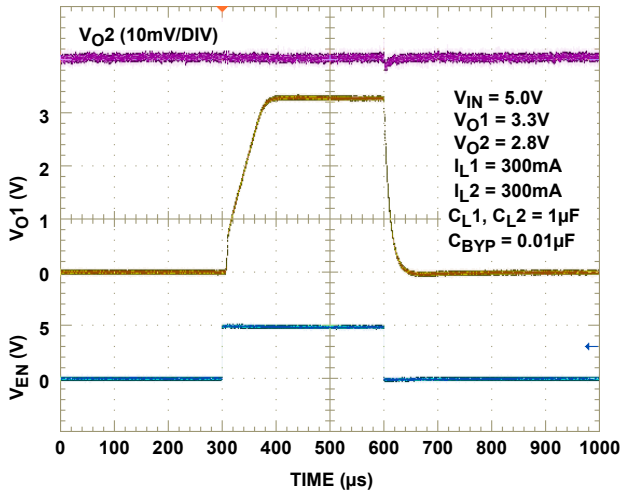

FIGURE 15. TURN-ON/TURN-OFF RESPONSE

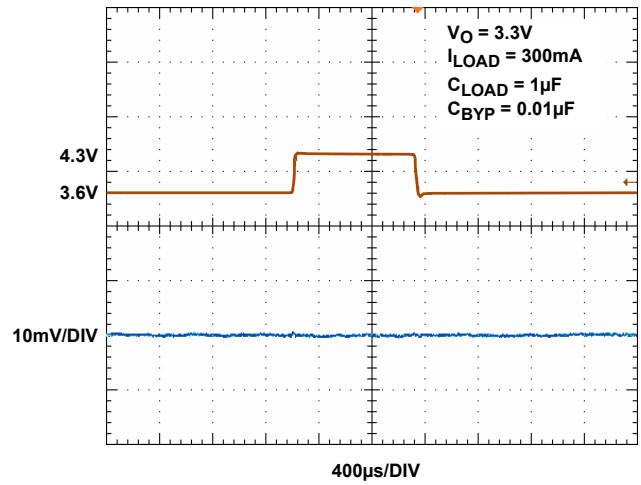

FIGURE 16. LINE TRANSIENT RESPONSE (3.3V OUTPUT)

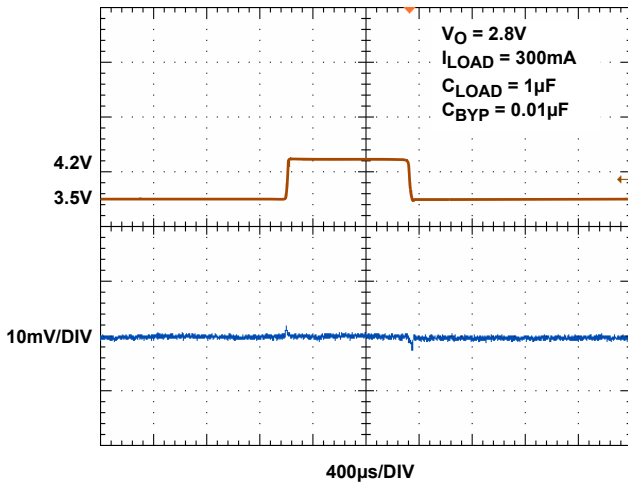

FIGURE 17. LINE TRANSIENT RESPONSE (2.8V OUTPUT)

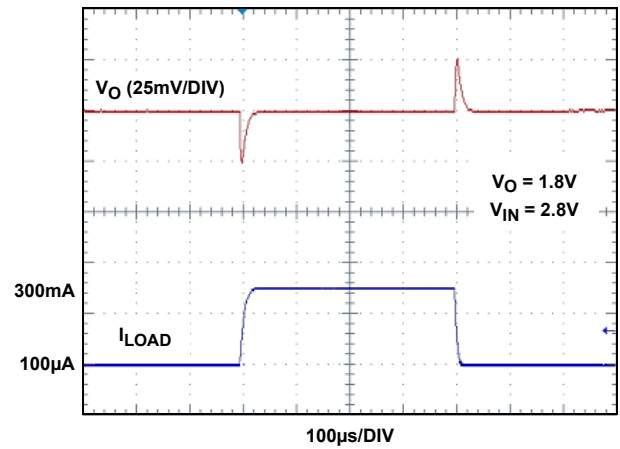

FIGURE 18. LOAD TRANSIENT RESPONSE

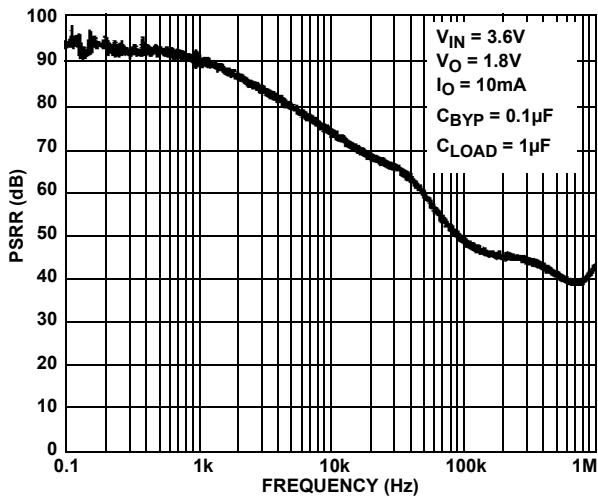

FIGURE 19. PSRR vs FREQUENCY

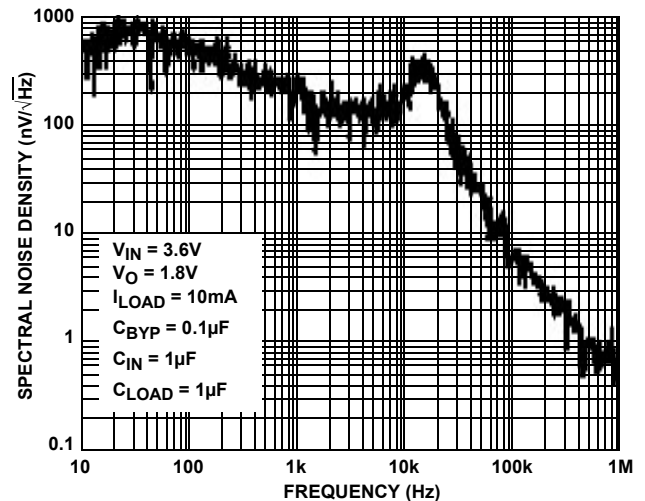

FIGURE 20. SPECTRAL NOISE DENSITY vs FREQUENCY

## Functional Description

The ISL78302A contains two high-performance LDOs. High performance is achieved through a circuit that delivers fast transient response to varying load conditions. In a quiescent condition, the ISL78302A adjusts its biasing to achieve the lowest standby current consumption.

The device also integrates current limit protection, smart thermal shutdown protection, staged turn-on, and soft-start. Smart thermal shutdown protects the device against overheating. Staged turn-on and soft-start minimize start-up input current surges without causing excessive device turn-on time.

### Power Control

The ISL78302A has two separate enable pins (EN1 and EN2) to individually control power to each of the LDO outputs. When both EN1 and EN2 are low, the device is in shutdown mode. During this condition, all on-chip circuits are off, and the device draws minimum current, typically less than 0.3 $\mu$ A.

When one or both of the enable pins are asserted, the device first polls the output of the UVLO detector to ensure that VIN voltage is at least about 2.1V. Once verified, the device initiates a start-up sequence. During the start-up sequence, trim settings are first read and latched. Then, sequentially, the bandgap, reference voltage, and current generation circuitry power up. Once the references are stable, a fast-start circuit quickly charges the external reference bypass capacitor (connected to the CBYP pin) to the proper operating voltage. After the bypass capacitor has been charged, the LDOs power up in their specified sequence.

Soft-start circuitry integrated into each LDO limits the initial ramp-up rate to about 30 $\mu$ s/V to minimize current surge.

If EN1 is brought high, and EN2 goes high before the VO1 output stabilizes, the ISL78302A delays the VO2 turn-on until the VO1 output reaches its target level.

If EN2 is brought high, and EN1 goes high before VO2 starts its output ramp, then VO1 turns on first, and the ISL78302A delays the VO2 turn-on until the VO1 output reaches its target level.

If EN2 is brought high, and EN1 goes high after VO2 starts its output ramp, then the ISL78302A immediately starts to ramp up the VO1 output.

If both EN1 and EN2 are brought high at the same time, the VO1 output has priority, and is always powered up first.

During operation, whenever the VIN voltage drops below about 1.8V, the ISL78302A immediately disables both LDO outputs. When VIN rises back above 2.1V, the device re-initiates its start-up sequence, and LDO operation resumes automatically.

### Reference Generation

The reference generation circuitry includes a trimmed bandgap, a trimmed voltage reference divider, a trimmed current reference generator, and an RC noise filter. The filter includes the external capacitor connected to the CBYP pin. A 0.01 $\mu$ F capacitor connected to CBYP implements a 100Hz lowpass filter and is recommended for most high-performance applications. For the lowest noise application, a 0.1 $\mu$ F or greater CBYP capacitor should be used. This filters the reference noise below the 10Hz to

1kHz frequency band, which is crucial in many noise-sensitive applications.

The bandgap generates a zero temperature coefficient (TC) voltage for the reference divider. The reference divider provides the regulation reference, POR detection thresholds, and other voltage references required for current generation and over-temperature detection.

The current generator provides the references required for adaptive biasing as well as references for LDO output current limit and thermal shutdown determination.

### LDO Regulation and Programmable Output Divider

The LDO regulator is implemented with a high-gain operational amplifier driving a PMOS pass transistor. The design of the ISL78302A provides a regulator that has low quiescent current, fast transient response, and overall stability across all operating and load current conditions. LDO stability is guaranteed for a 1 $\mu$ F to 10 $\mu$ F output capacitor that has a tolerance better than 20% and ESR less than 200m $\Omega$ . The design is performance-optimized for a 1 $\mu$ F capacitor. Unless limited by the application, use of an output capacitor value above 4.7 $\mu$ F is not normally needed as LDO performance improvement is minimal.

Each LDO uses an independently trimmed 1V reference. An internal resistor divider drops the LDO output voltage down to 1V. This is compared to the 1V reference for regulation.

### Power-On Reset Generation

Each LDO has a separate power-on reset (POR) signal generation circuit that outputs to the respective POR pins. The POR signal is generated as follows.

A POR comparator continuously monitors the output of each LDO. The LDO enters a power-good state when the output voltage is above 94% of the expected output voltage for a period exceeding the LDO PGOOD entry delay time. In the power-good state, the open-drain PORx output is in a high-impedance state. An internal 100k $\Omega$  pull-up resistor pulls the pin up to the respective LDO output voltage. An external resistor can be added between the PORx output and the LDO output for a faster rise time; however, the PORx output should not connect through an external resistor to a supply greater than the associated LDO voltage.

For the 1.5V regulated output option, it has been found that the internal pull-ups on POR output does not always function correctly above  $V_{IN} = 6V$ . For this reason, it is recommended to use an external 100k $\Omega$  pull-up resistor for the POR pin that is associated to the 1.5V output. For outputs higher than 1.5V, no external resistor is required over the full input range from 2.3V to 6.5V.

The power-good state is exited when the LDO output falls below 90% of the expected output voltage for a period longer than the PGOOD exit delay time. While power-good is false, the ISL78302A pulls the respective POR pin low.

For LDO-1, the PGOOD entry delay time is fixed at about 2ms while the PGOOD exit delay is about 25 $\mu$ s. For LDO-2, the PGOOD entry and exit delays are determined by the value of the external capacitor connected to the CPOR pin. For a 0.01 $\mu$ F capacitor, the

entry and exit delays are 200ms and 25 $\mu$ s, respectively. Larger or smaller capacitor values yield proportionately longer or shorter delay times. The POR exit delay should never be allowed to be less than 10 $\mu$ s to ensure sufficient immunity against transient induced false POR triggering.

### Overheat Detection

The bandgap provides a proportional-to-temperature current that is indicative of the temperature of the silicon. This current is compared with references to determine if the device is in danger of damage due to overheating. When the die temperature reaches about +145 $^{\circ}$ C, one or both of the LDOs momentarily shuts down until the die cools sufficiently. In the overheat condition, only the LDO sourcing more than 50mA is shut off. This does not affect the operation of the other LDO. If both LDOs source more than 50mA and an overheat condition occurs, both LDO outputs are disabled. Once the die temperature falls back below about +110 $^{\circ}$ C, the disabled LDOs are re-enabled, and soft-start automatically takes place.

The ISL78302A provides short-circuit protection by limiting the output current to about 475mA. If short circuited, an output current of 475mA will cause die heating. If the short circuit lasts long enough, the overheat detection circuit will turn off the output.

© Copyright Intersil Americas LLC 2012-2015. All Rights Reserved.  
All trademarks and registered trademarks are the property of their respective owners.

For additional products, see [www.intersil.com/en/products.html](http://www.intersil.com/en/products.html)

---

Intersil Automotive Qualified products are manufactured, assembled and tested utilizing TS16949 quality systems as noted in the quality certifications found at [www.intersil.com/en/support/qualandreliability.html](http://www.intersil.com/en/support/qualandreliability.html)

---

*Intersil products are sold by description only. Intersil may modify the circuit design and/or specifications of products at any time without notice, provided that such modification does not, in Intersil's sole judgment, affect the form, fit or function of the product. Accordingly, the reader is cautioned to verify that datasheets are current before placing orders. Information furnished by Intersil is believed to be accurate and reliable. However, no responsibility is assumed by Intersil or its subsidiaries for its use; nor for any infringements of patents or other rights of third parties which may result from its use. No license is granted by implication or otherwise under any patent or patent rights of Intersil or its subsidiaries.*

---

For information regarding Intersil Corporation and its products, see [www.intersil.com](http://www.intersil.com)

## Revision History

The revision history provided is for informational purposes only and is believed to be accurate, but not warranted. Please go to web to make sure you have the latest revision.

| DATE              | REVISION | CHANGE  |
|-------------------|----------|---|
| December 22, 2015 | FN7932.2 | On page 4, updated Charged Device Model test method from "JESD22-C101C" to "AEC-Q100-011".<br>Updated POD L10.3x3C to current version with changes as follows:<br>Removed package outline and included center to center distance between lands on recommended land pattern.<br>Removed Note 4 "Dimension b applies to the metallized terminal and is measured between 0.18mm and 0.30mm from the terminal tip." since it is not applicable to this package. Renumbered notes accordingly.<br>Tiebar Note 4 updated<br>From: Tiebar shown (if present) is a non-functional feature.<br>To: Tiebar shown (if present) is a non-functional feature and may be located on any of the 4 sides (or ends). |
| December 23, 2013 | FN7932.1 | Page 10<br>- 2nd line of the disclaimer changed from:<br>"Intersil products are manufactured, assembled and tested utilizing ISO9001 quality systems as noted"<br>to:<br>"Intersil Automotive Qualified products are manufactured, assembled and tested utilizing TS16949 quality systems as noted"   |
| May 21, 2012      | FN7932.0 | Initial Release   |

## About Intersil

Intersil Corporation is a leading provider of innovative power management and precision analog solutions. The company's products address some of the largest markets within the industrial and infrastructure, mobile computing and high-end consumer markets.

For the most updated datasheet, application notes, related documentation and related parts, please see the respective product information page found at [www.intersil.com](http://www.intersil.com).

You may report errors or suggestions for improving this datasheet by visiting [www.intersil.com/ask](http://www.intersil.com/ask).

Reliability reports are also available from our website at [www.intersil.com/support](http://www.intersil.com/support).

# Package Outline Drawing

## L10.3x3C

10 LEAD DUAL FLAT PACKAGE (DFN)

Rev 4, 3/15

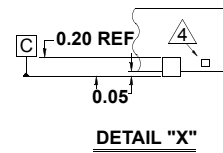
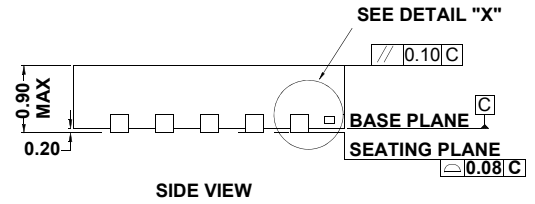
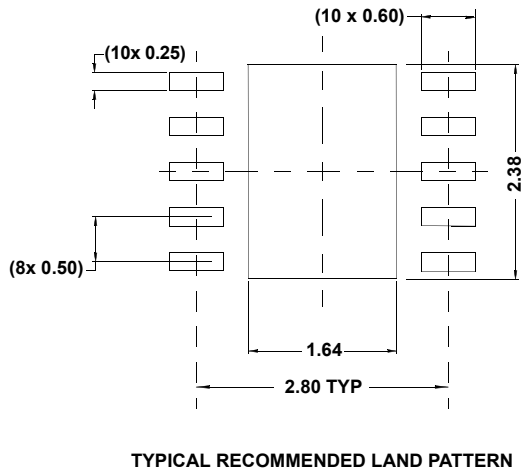
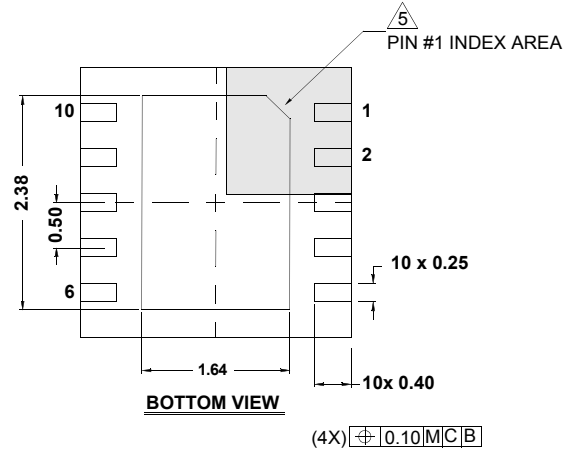
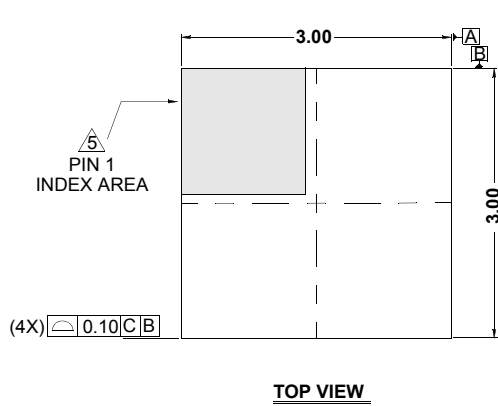



**NOTES:**

1. Dimensions are in millimeters.  
Dimensions in ( ) for Reference Only.
2. Dimensioning and tolerancing conform to AMSE Y14.5m-1994.
3. Unless otherwise specified, tolerance : Decimal  $\pm 0.05$
4. Tiebar shown (if present) is a non-functional feature and may be located on any of the 4 sides (or ends).
5. The configuration of the pin #1 identifier is optional, but must be located within the zone indicated. The pin #1 identifier may be either a mold or mark feature.
6. Compliant to JEDEC MO-229-WEED-3 except for E-PAD dimensions.

## Looking for pricing, stock, or lifecycle information?

Click below to explore more details on WIN SOURCE:

-  [View ISL78302AARJCZ on WIN SOURCE](#)
-  [Renesas Electronics America](#) Information

## Optimize Your Supply Chain with WIN SOURCE Solutions

-  Global Sourcing Solution
-  Obsolete Management
-  Cost Control Management
-  Shortage Management
-  Alternative Solution
-  Excess Inventory Management