



**THE DATASHEET OF  
BU33UV7NUX-E2**



# Synchronous Boost DC/DC Converter (LOAD:500mA @V<sub>OUT</sub>=3.3V, V<sub>IN</sub>=1.8V)

## BU33UV7NUX

### General Description

BU33UV7NUX is a synchronous boost converter with low power consumption and provides a power supply for products powered by either two-cell alkaline/NiCd/NiMH or one-cell alkaline/Li-ion or Li-polymer battery. Output currents can go as high as 500mA (V<sub>IN</sub>=1.8V). BU33UV7NUX has reset circuit. (Detection voltage:1.5V, Release Voltage:1.9V) BU33UV7NUX output voltage is fixed 3.3V by internal resistor divider. V<sub>OUT</sub> is connected with V<sub>IN</sub> when V<sub>IN</sub> voltage is higher than 3.3V.

### Features

- Synchronous Boost DC/DC Converter I<sub>max</sub> 500mA @V<sub>OUT</sub>=3.3V, V<sub>IN</sub>=1.8V(T<sub>a</sub>=25°C)
- Disconnect Function during EN-OFF and UVLO
- Auto-PFM/PWM (MODE=H(=V<sub>IN</sub>)), Fixed PFM (MODE=L(=0V))
- Reset Function (Detect Voltage = 1.5V)
- Pass-Through Function (V<sub>IN</sub> > V<sub>OUT</sub>)
- Thermal Shutdown
- 10-Pin "VSON010X3020" Package

### Key Specifications

- Input Voltage Range 0.6V to 4.5V
- Fixed Output Voltage 3.3V
- Efficiency 94%(Max)
- Current Consumption 7μA(MODE=Low)  
13μA(MODE=High)
- Start-up Voltage 0.9V

### Package

VSON010X3020

### W(Typ) x D(Typ) x H(Max)

3.00mm x 2.00mm x 0.60mm

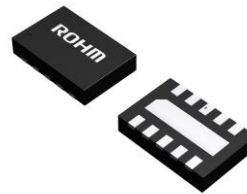

### Applications

- Single-Cell or Two-Cell Alkaline
- NiCd/NiMH or Single-Cell Li Battery-Powered Products
- IC Recorders
- Wireless Mouse
- Portable Audio Players
- Cellular Phones
- Personal Medical Products
- Remote Controllers

### Typical Application Circuit

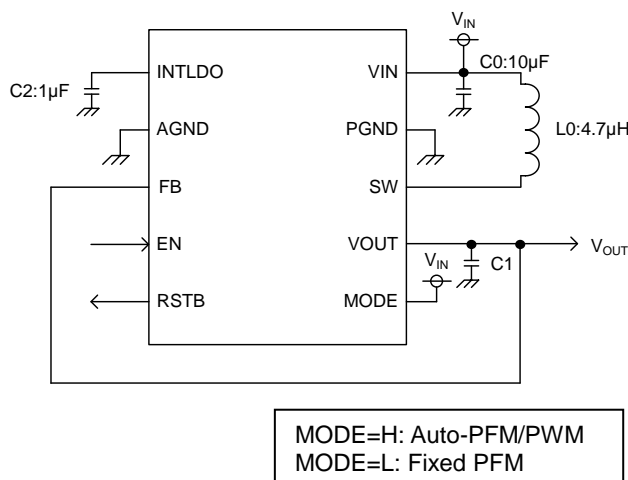

Figure 1. Application Circuit

### Typical Performance Characteristics

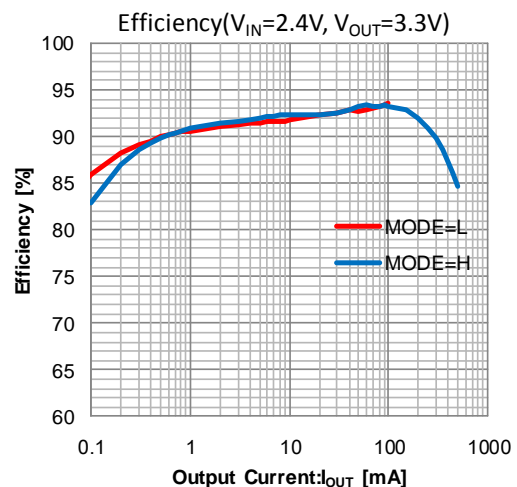

Figure 2. Efficiency

Pin Configuration

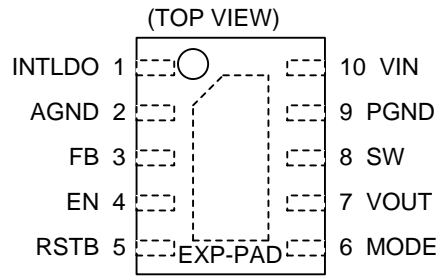

Figure 3. Pin Configuration

Pin Descriptions

Pin No.	Pin Name	Function
1	INTLDO	Internal power supply
2	AGND	GND
3	FB	Output feedback
4	EN	EN= V <sub>IN</sub> : Power-ON EN=GND: Power-OFF
5	RSTB	Low battery detection
6	MODE	MODE = V <sub>IN</sub> : Auto-PFM/PWM MODE =GND: Fixed PFM
7	VOUT	Boost voltage output
8	SW	Inductor connection
9	PGND	Power GND
10	VIN	Power supply
-	EXP-PAD	The EXP-PAD is not connected any other pins inside the package.

(Note) Do not use the EN and MODE pin at open.

Block Diagram

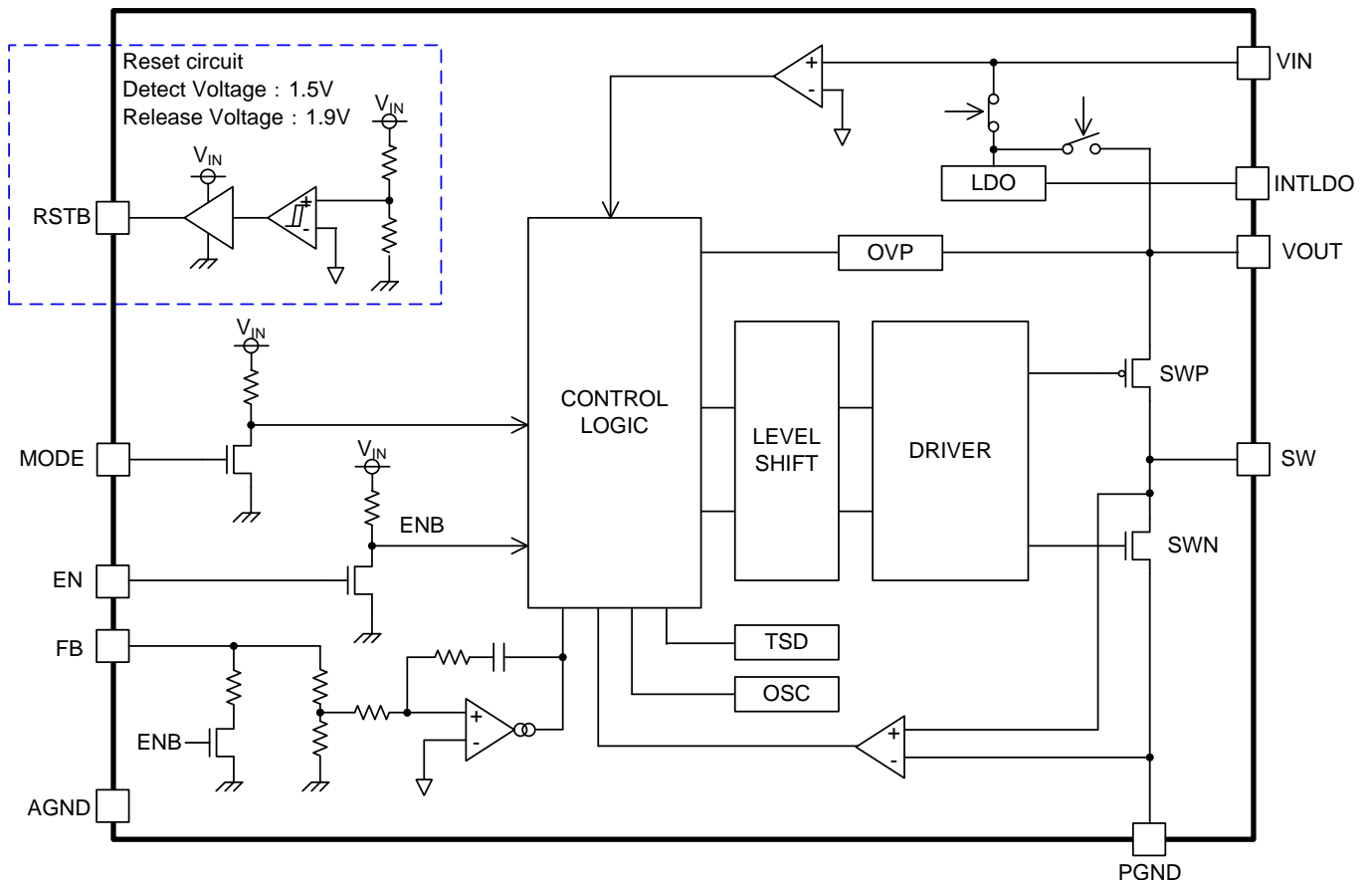

Figure 4. Circuit Block

**Absolute Maximum Ratings (Ta=25 °C)**

Parameter	Symbol	Ratings	Unit
Maximum Applied Voltage1	Vmax1	6.5	V
Maximum Applied Voltage2 [INTLDO]	Vmax2	2.5	V
Maximum Junction Temperature	Tjmax	125	°C
Storage Temperature Range	Tstg	-55 to +125	°C

**Caution 1:** Operating the IC over the absolute maximum ratings may damage the IC. The damage can either be a short circuit between pins or an open circuit between pins and the internal circuitry. Therefore, it is important to consider circuit protection measures, such as adding a fuse, in case the IC is operated over the absolute maximum ratings.

**Caution 2:** Should by any chance the maximum junction temperature rating be exceeded the rise in temperature of the chip may result in deterioration of the properties of the chip. In case of exceeding this absolute maximum rating, design a PCB with thermal resistance taken into consideration by increasing board size and copper area so as not to exceed the maximum junction temperature rating.

**Thermal Resistance<sup>(Note 1)</sup>**

Parameter	Symbol	Thermal Resistance (Typ)		Unit
		1s <sup>(Note 3)</sup>	2s2p <sup>(Note 4)</sup>	
VSON010X3020				
Junction to Ambient	$\theta_{JA}$	274.8	39.4	°C/W
Junction to Top Characterization Parameter <sup>(Note 2)</sup>	$\Psi_{JT}$	31	6	°C/W

(Note 1) Based on JESD51-2A(Still-Air)

(Note 2) The thermal characterization parameter to report the difference between junction temperature and the temperature at the top center of the outside surface of the component package.

(Note 3) Using a PCB board based on JESD51-3.

Layer Number of Measurement Board	Material	Board Size
Single	FR-4	114.3mm x 76.2mm x 1.57mm
Top		
Copper Pattern	Thickness	
Footprints and Traces	70 $\mu$ m	

(Note 4) Using a PCB board based on JESD51-5, 7.

Layer Number of Measurement Board	Material	Board Size	Thermal Via <sup>(Note 5)</sup>		
			Pitch	Diameter	
4 Layers	FR-4	114.3mm x 76.2mm x 1.6mm	1.20mm	$\Phi$ 0.30mm	
Top		2 Internal Layers		Bottom	
Copper Pattern	Thickness	Copper Pattern	Thickness	Copper Pattern	Thickness
Footprints and Traces	70 $\mu$ m	74.2mm x 74.2mm	35 $\mu$ m	74.2mm x 74.2mm	70 $\mu$ m

(Note 5) This thermal via connects with the copper pattern of all layers.

## Recommended Operating Conditions

Parameter	Symbol	Min	Typ	Max	Unit
Power Supply Voltage	V <sub>IN</sub>	0.6 <sup>(Note 1)</sup>	-	4.5	V
Operating Temperature	Topr	-40	-	+85	°C

(Note 1) When it is V<sub>OUT</sub>=3.3VElectrical Characteristics (Unless otherwise specified V<sub>IN</sub>=2.4V, L<sub>0</sub>=4.7μH, C<sub>1</sub>=22μF×2, Ta=25°C)

Parameter	Symbol	Min	Typ	Max	Unit	Condition
Circuit Current1	I <sub>CC1</sub>	-	2.7	8.0	μA	EN=0V, V <sub>IN</sub> =1.2V
Circuit Current2	I <sub>CC2</sub>	-	7	18	μA	EN=H, MODE=L, Device not switching
Circuit Current3	I <sub>CC3</sub>	-	13	25	μA	EN=H, MODE=H, Device not switching
Switching Frequency	f <sub>SW</sub>	720	800	880	kHz	
Output Voltage MODE=H	V <sub>OUTMH</sub>	3.262	3.3	3.343	V	I <sub>OUT</sub> =1mA, MODE=H
Output Voltage MODE=L	V <sub>OUTML</sub>	3.1	3.3	3.5	V	I <sub>OUT</sub> =1mA, MODE=L
Maximum Output Current1	I <sub>MAX1</sub>	50	-	-	mA	MODE=L, V <sub>IN</sub> =1.8V
Maximum Output Current2	I <sub>MAX2</sub>	500	-	-	mA	MODE=H, V <sub>IN</sub> =1.8V
EN Input High	V <sub>IH_EN</sub>	0.6	-	-	V	
EN Input Low	V <sub>IL_EN</sub>	-	-	0.2	V	
SWN Switch On Resistance	R <sub>SWN</sub>	-	140	-	mΩ	
SWP Switch On Resistance	R <sub>SWP</sub>	-	330	-	mΩ	
RST Release Threshold	V <sub>RSTR</sub>	1.868	1.9	1.930	V	
RST Detect Threshold	V <sub>RSTD</sub>	-	1.5	-	V	
RST Hysteresis	V <sub>RSTHYS</sub>	-	0.4	-	V	
RSTB Output Low Voltage	V <sub>OL</sub>	-	0	0.1	V	I <sub>sink</sub> =20μA, V <sub>IN</sub> =0.9V
RSTB Output High Voltage	V <sub>OH</sub>	V <sub>IN</sub> -0.5	-	-	V	I <sub>source</sub> =1mA
Minimum Start-up Voltage	V <sub>MIN</sub>	0.875	0.9	0.925	V	(Note 2)
Minimum Input Voltage after Start-up	V <sub>MINAFT</sub>	-	0.26	0.6	V	
Over Current Protection	I <sub>OCP</sub>	1.3	1.55	1.8	A	
OVP Detect Threshold	V <sub>OVPD</sub>	5.5	6	6.5	V	V <sub>OUT</sub> Rising
Discharge Resistance	R <sub>DIS</sub>	-	90	-	Ω	

(Note 2) Resistive load = 3.3kΩ, V<sub>OUT</sub> = 3.3V at 1mA.

Typical Performance Curves(Unless otherwise indicated,  $V_{IN}=2.4V, V_{OUT}=3.3V, L_0=4.7\mu H, C_1=22\mu F \times 2, T_a=25^\circ C$ )

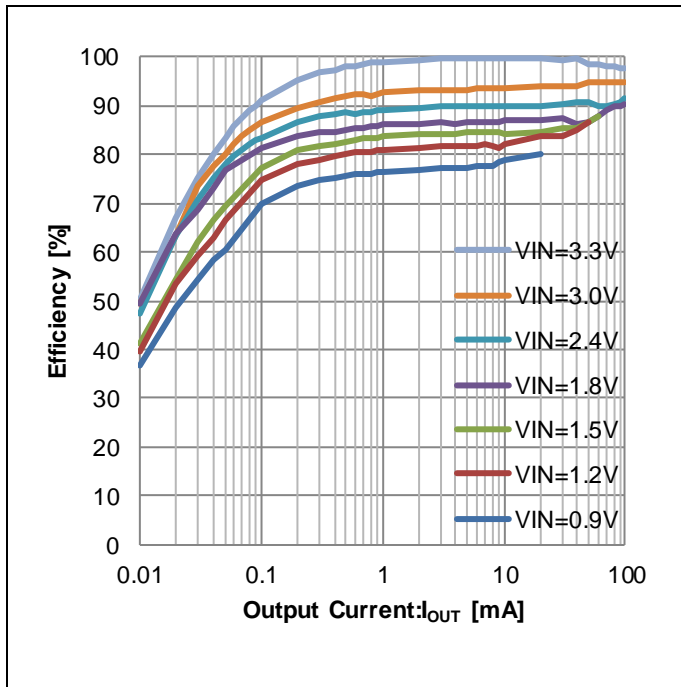

Figure 5. Efficiency vs Output Current (MODE=L: Fixed PFM)

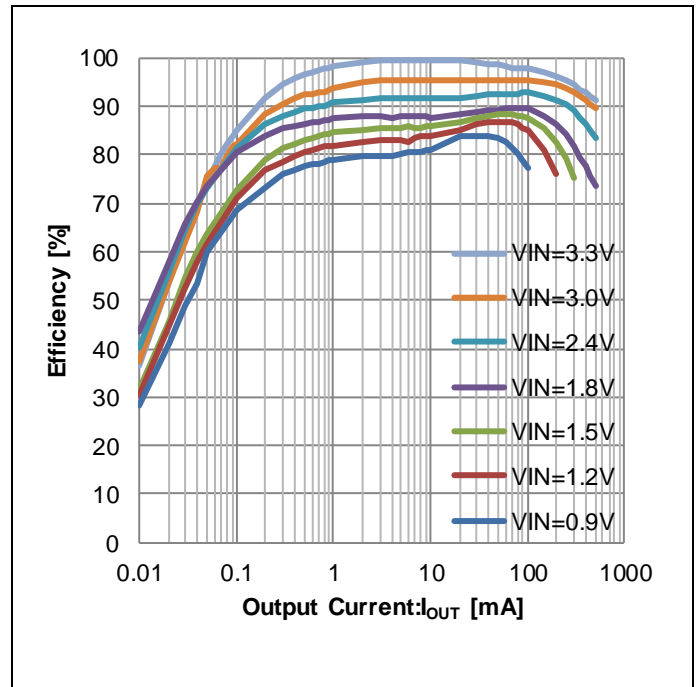

Figure 6. Efficiency vs Output Current (MODE=H: Auto-PFM/PWM)

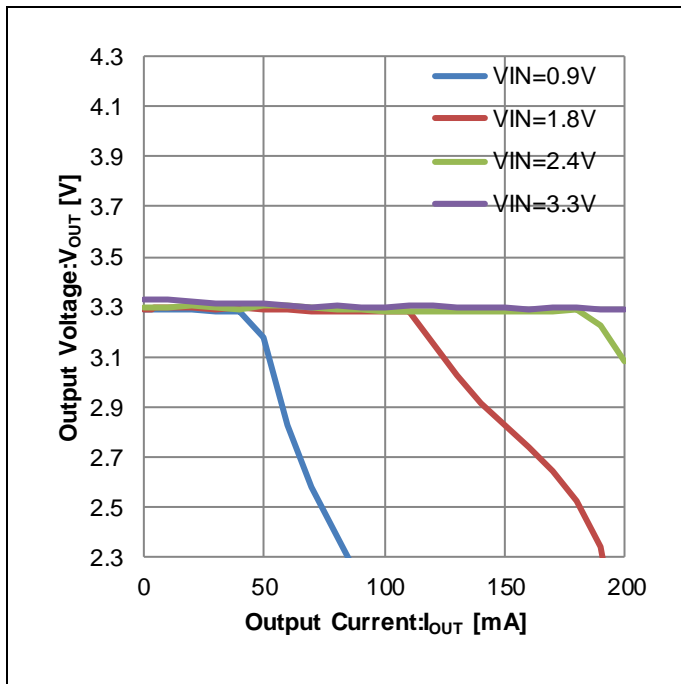

Figure 7. Output Voltage vs Output Current ("Load Regulation", MODE=L: Fixed PFM)

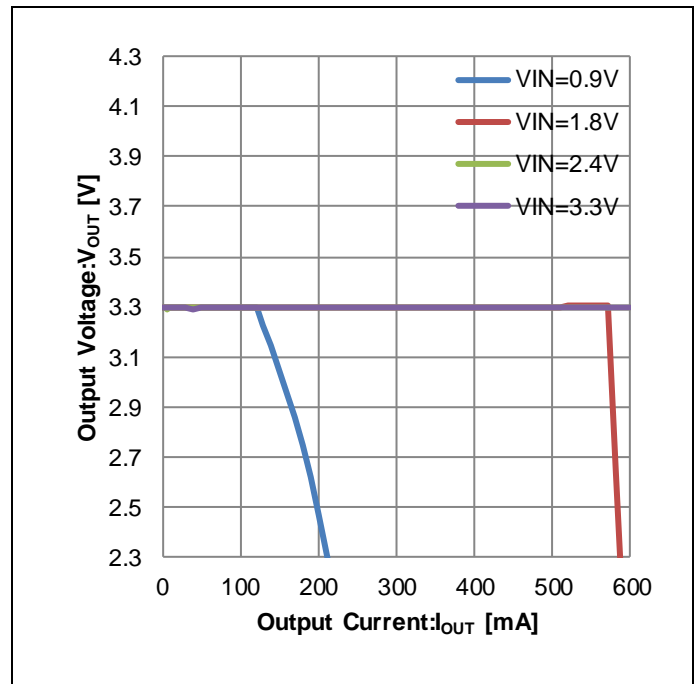

Figure 8. Output Voltage vs Output Current ("Load Regulation", MODE=H: Auto-PFM/PWM)

Typical Performance Curves - continued

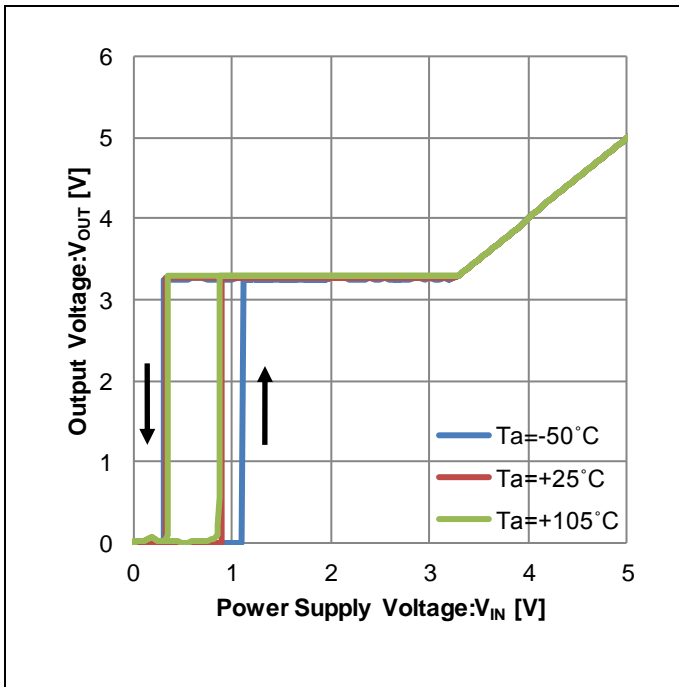

Figure 9. Output Voltage vs Power Supply Voltage (“Line Regulation”, MODE=H: Auto-PFM/PWM, 3.3kΩ resistive load)

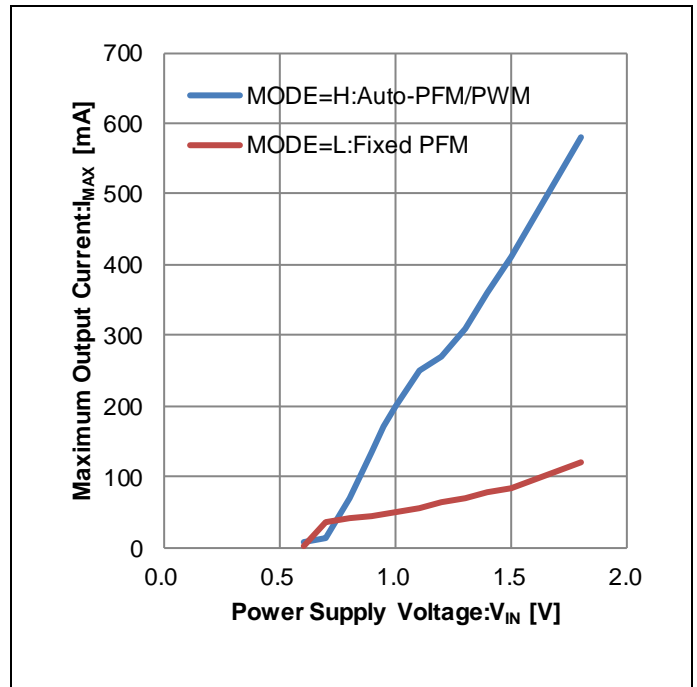

Figure 10. Maximum Output Current vs Power Supply Voltage

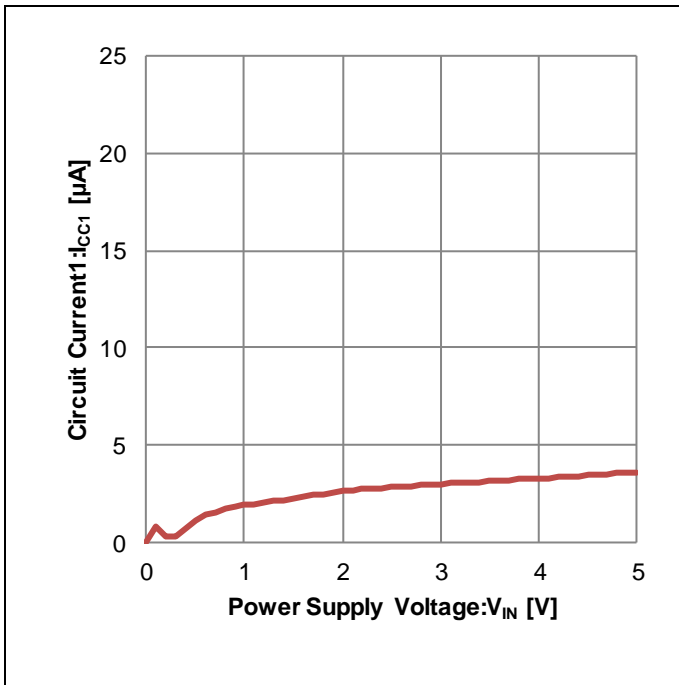

Figure 11. Circuit Current1 vs Power Supply Voltage (EN=MODE=L, No load)

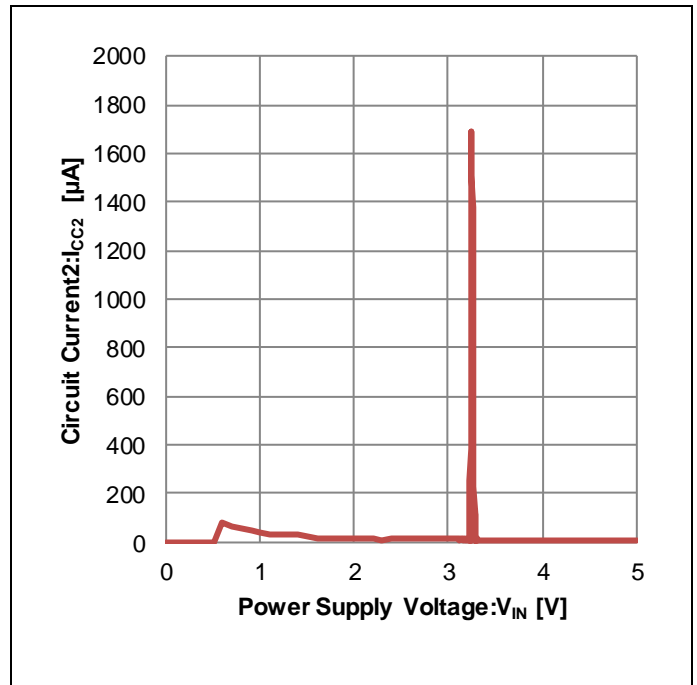

Figure 12. Circuit Current2 vs Power Supply Voltage (MODE=L: Fixed PFM, No load)

Typical Performance Curves - continued

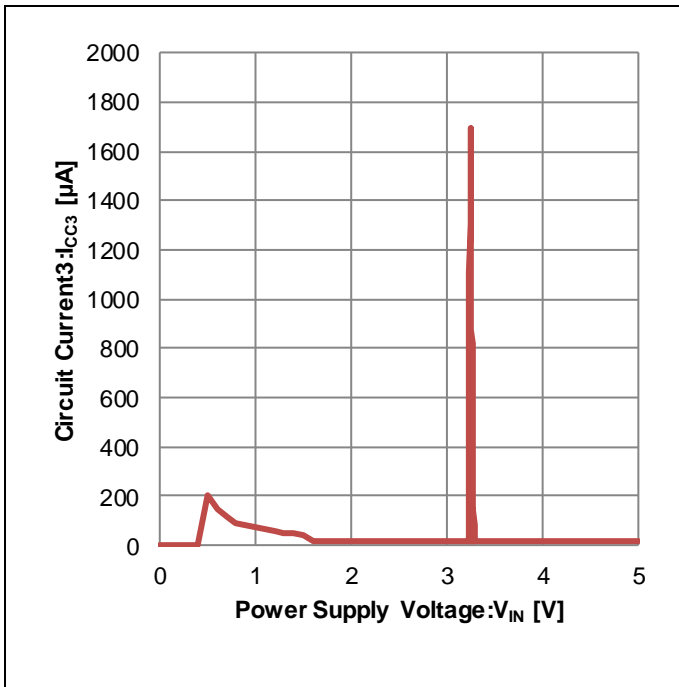

Figure 13. Circuit Current3 vs Power Supply Voltage (MODE=H: Auto-PFM/PWM, No load)

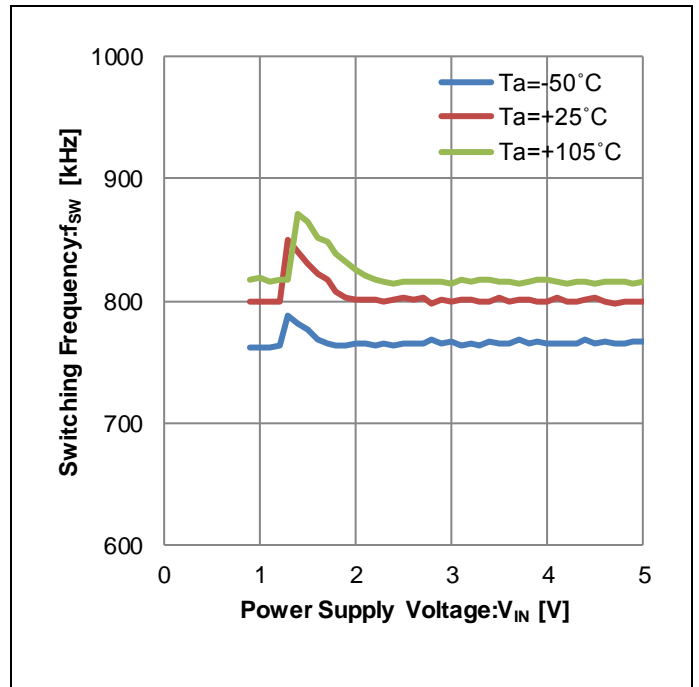

Figure 14. Switching Frequency vs Power Supply Voltage (MODE=H: Auto-PFM/PWM)

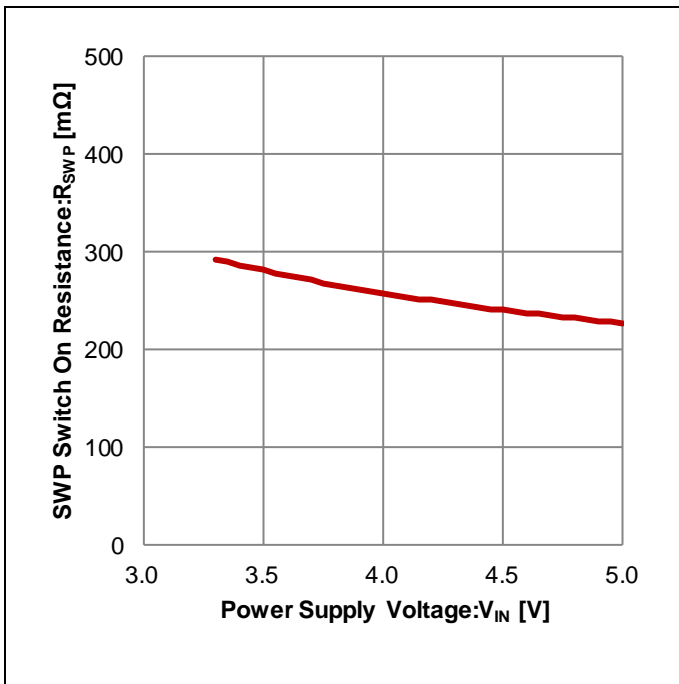

Figure 15. SWP Switch On Resistance vs Power Supply Voltage (MODE=H: Auto-PFM/PWM)

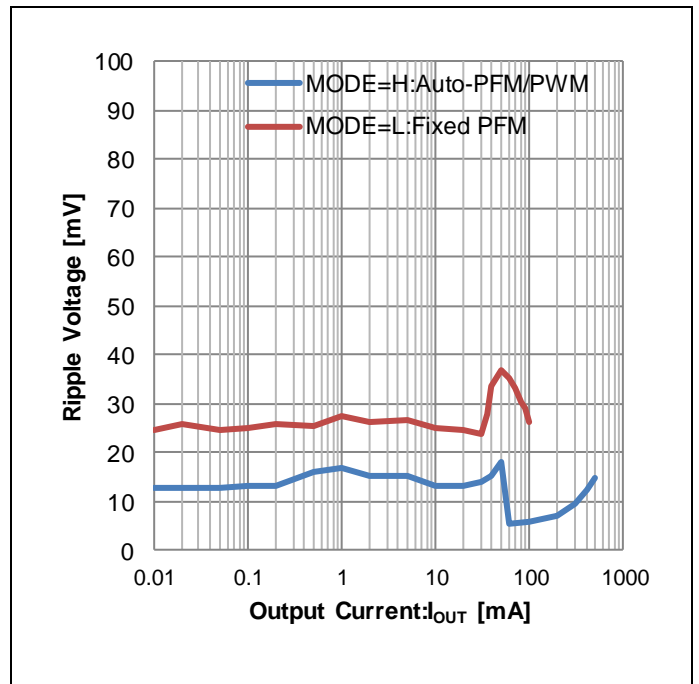

Figure 16. Ripple Voltage vs Output Current (VIN=2.4V)

Typical Performance Curves - continued

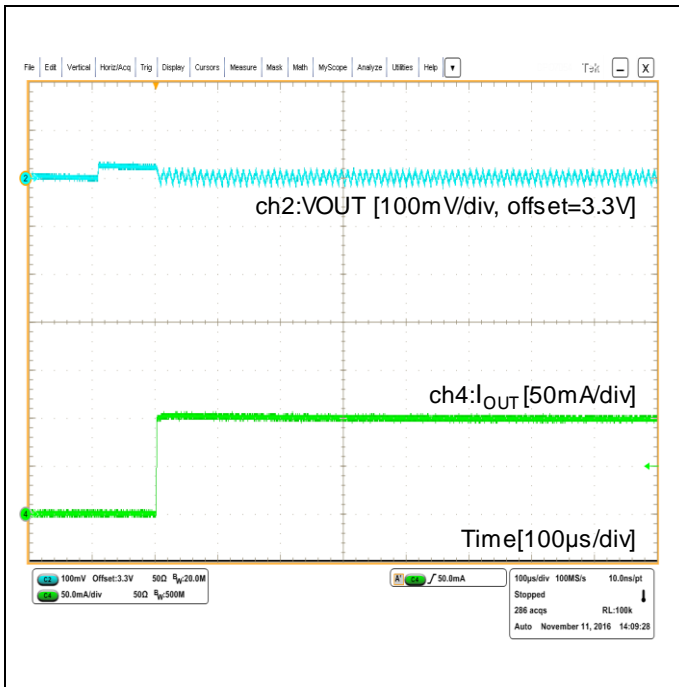

Figure 17. Transient Response ( $V_{IN}=2.4V$ , MODE=L: Fixed PFM, Output current 1mA $\leftrightarrow$ 100mA)

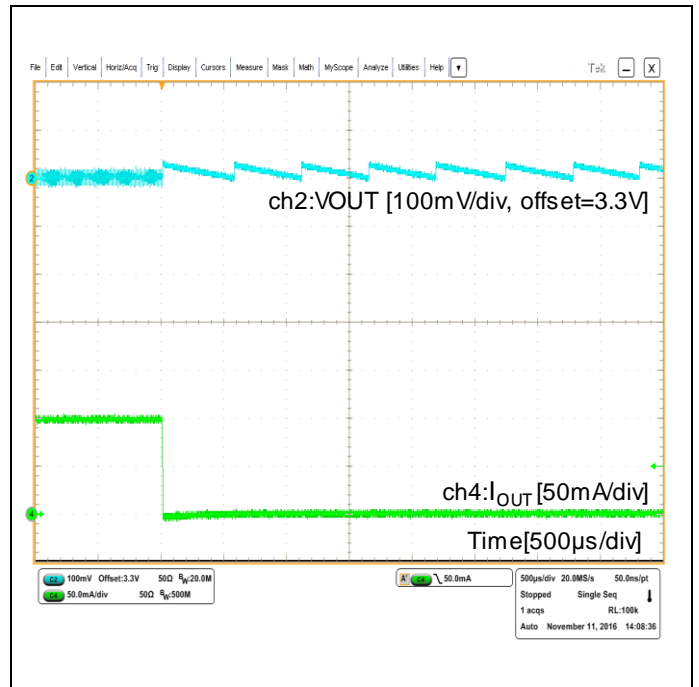

Figure 18. Transient Response ( $V_{IN}=2.4V$ , MODE=L: Fixed PFM, Output current 1mA $\leftrightarrow$ 100mA)

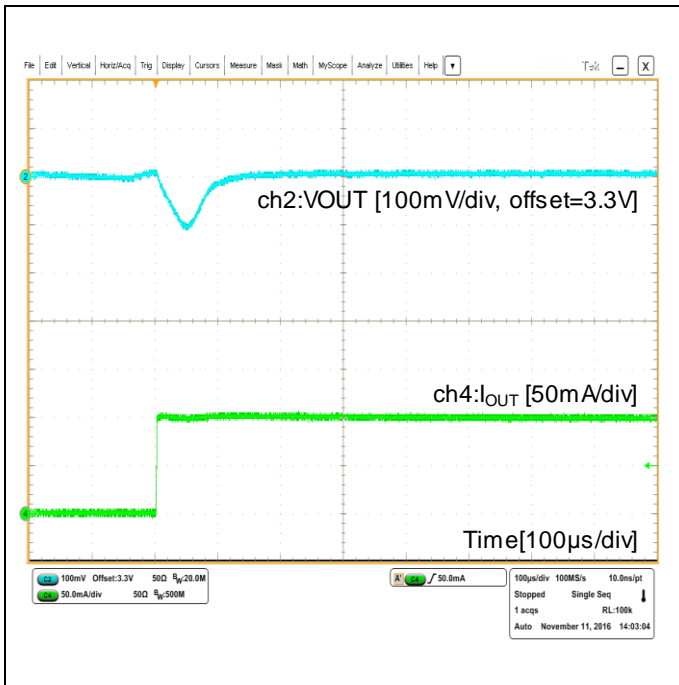

Figure 19. Transient Response ( $V_{IN}=2.4V$ , MODE=H: Auto-PFM/PWM, Output current 1mA $\leftrightarrow$ 100mA)

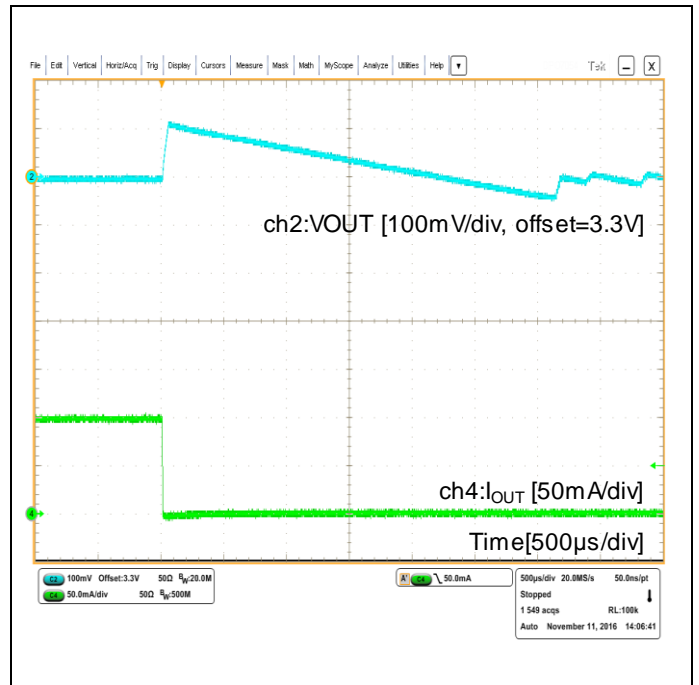

Figure 20. Transient Response ( $V_{IN}=2.4V$ , MODE=H: Auto-PFM/PWM, Output current 1mA $\leftrightarrow$ 100mA)

Typical Performance Curves - continued

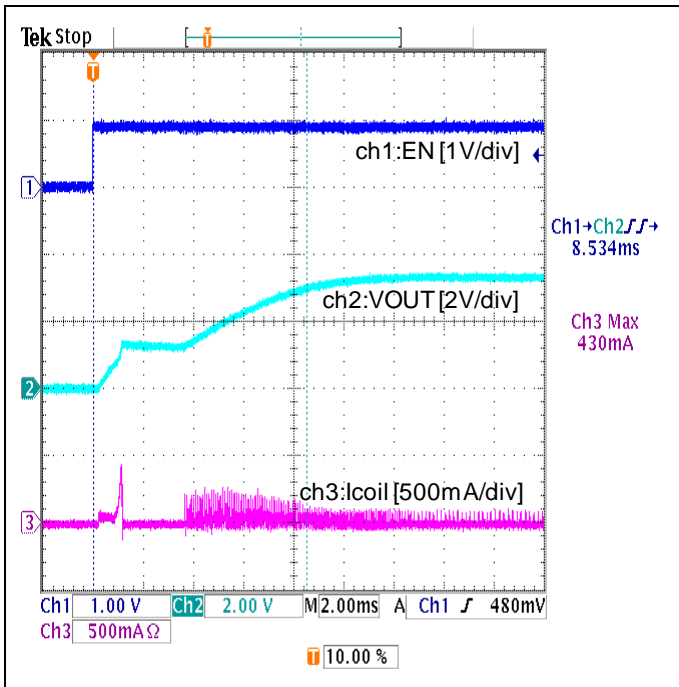

Figure 21. Start-up Waveform  
(VIN=0.9V, 3.3kΩ resistive load, MODE=L: Fixed PFM)

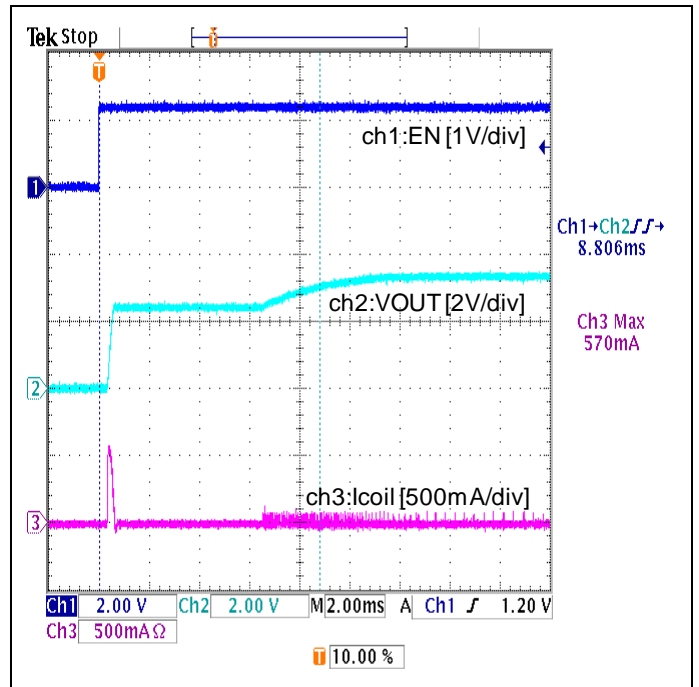

Figure 22. Start-up Waveform  
(VIN=2.4V, 3.3kΩ resistive load, MODE=L: Fixed PFM)

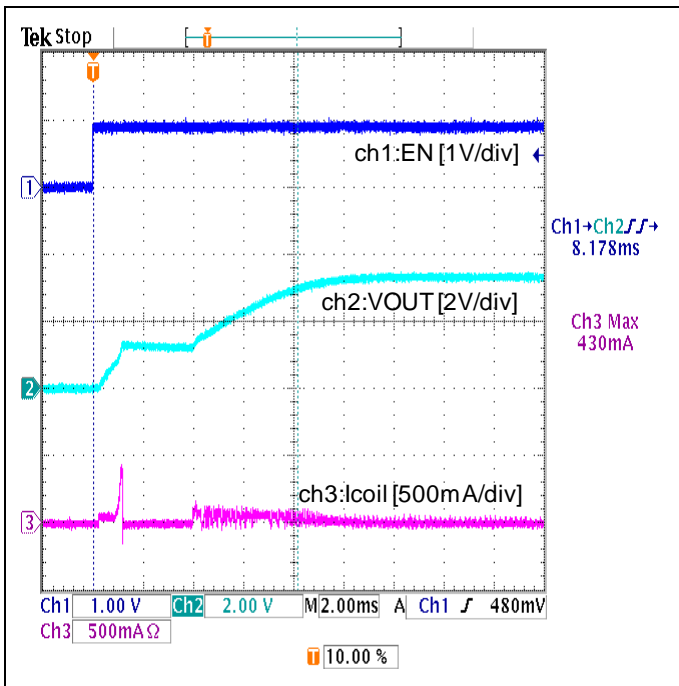

Figure 23. Start-up Waveform  
(VIN=0.9V, 3.3kΩ resistive load, MODE=H: Auto-PFM/PWM)

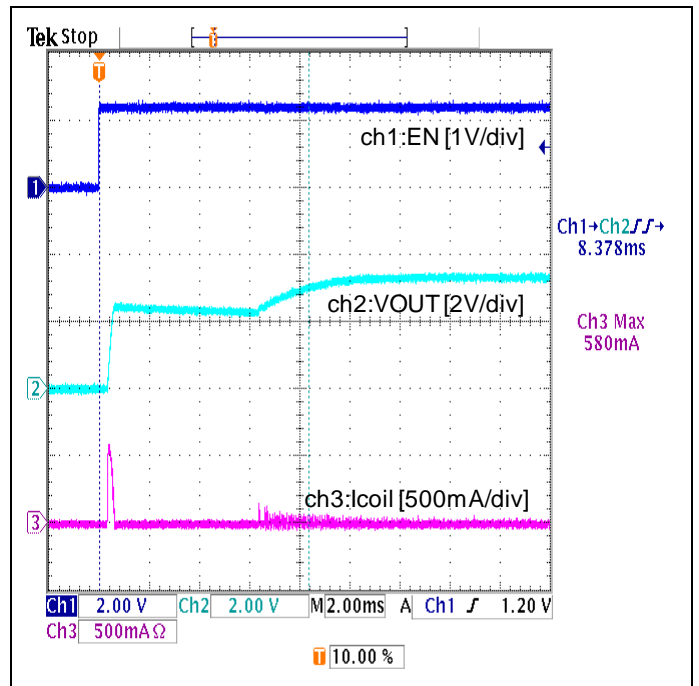

Figure 24. Start-up Waveform  
(VIN=2.4V, 3.3kΩ resistive load, MODE=H: Auto-PFM/PWM)

Typical Performance Curves - continued

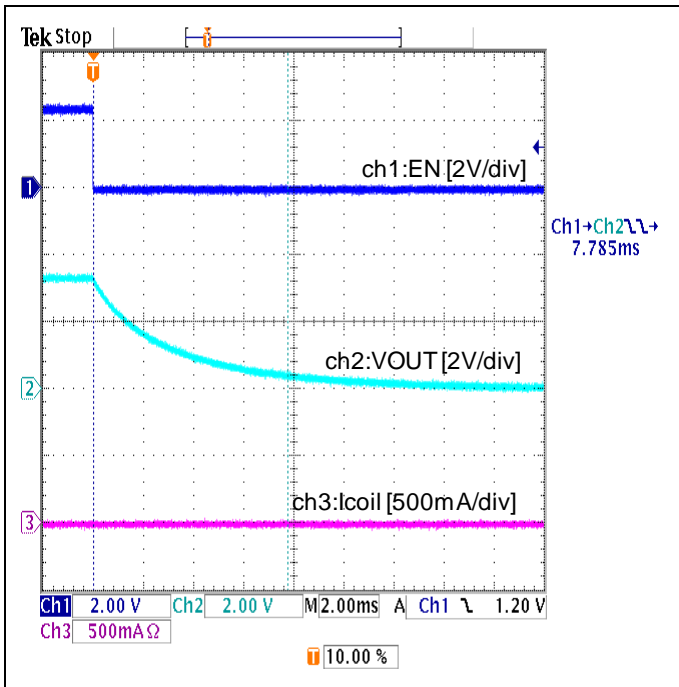

Figure 25. Shutdown Waveform  
(VIN=2.4V, Output current=0mA, MODE=L: Fixed PFM)

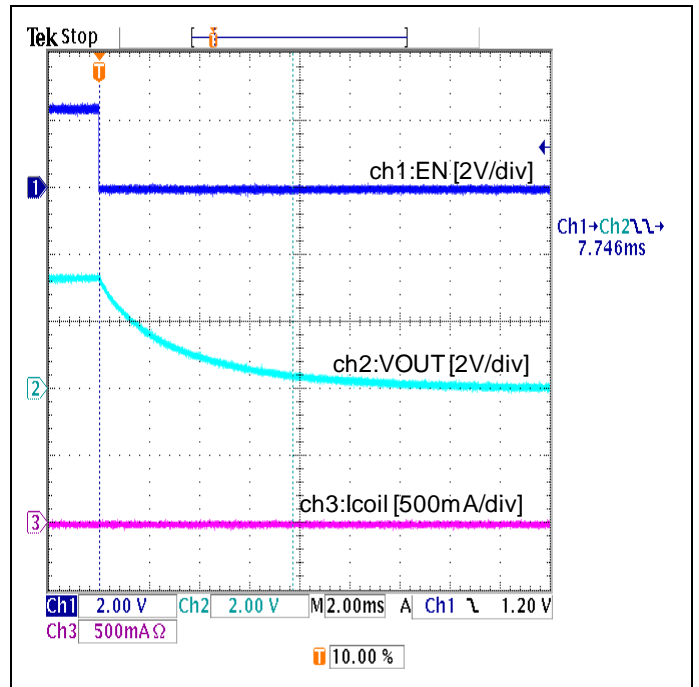

Figure 26. Shutdown Waveform  
(VIN=2.4V, Output current=0mA, MODE=H: Auto-PFM/PWM)

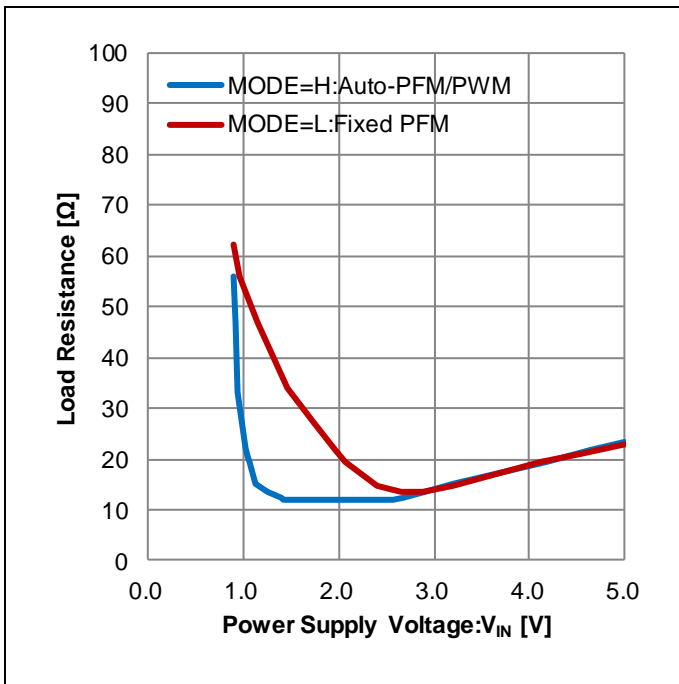

Figure 27. Load Resistance vs Power Supply Voltage  
("Minimum Load Resistance", Start-Up)

## Detailed Description

### 1. Start-up (SOFT START)

After being enabled, BU33UV7NUX starts the Soft Start operation. Firstly, high side switch MOSFET is turned on and the output voltage  $V_{OUT}$  is lifted to the input voltage  $V_{IN}$  level, applying restriction to current. (Current Restriction Operation) For this operation, up to around 1mA resistive load is allowed. Then, the device starts switching operation and  $V_{OUT}$  is risen up to setting voltage adjusting the output slew rate by DAC for Soft Start. (Soft Start Operation) This soft start operation is reset by EN, UVLO, TSD and SCP.

Attention is necessary to change input rush current and start-up time by the output capacitor.

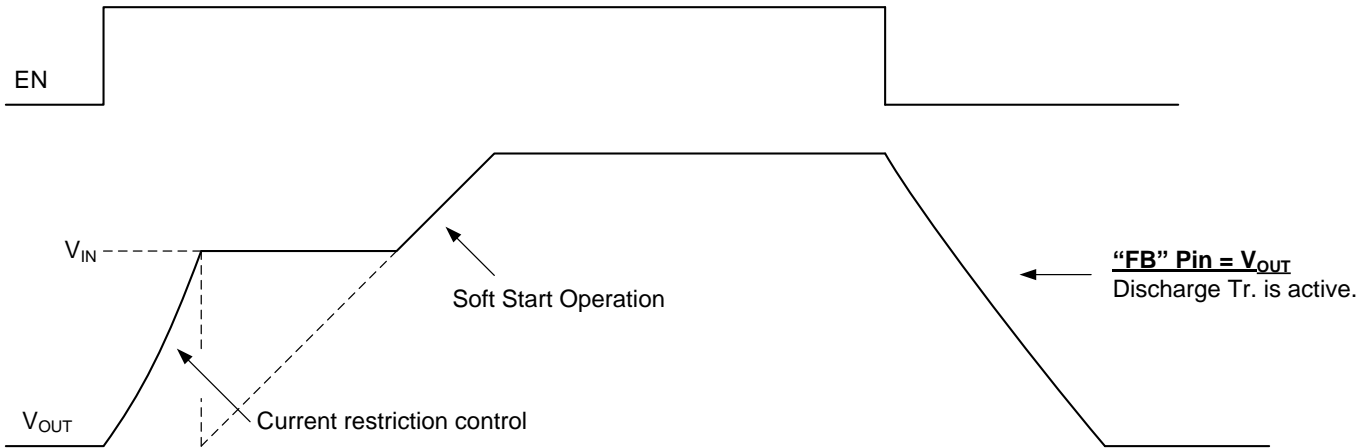

Figure 28. Start-up (Soft Start) and Shutdown Operation

### 2. Discharge for Output Pin

The FB pin is shorted to  $V_{OUT}$ ; the discharge Tr. in the device is active. The  $V_{OUT}$  pin is always discharged when DC/DC converter is in standby state.

### 3. Under Voltage Lock Out (UVLO)

UVLO prevents malfunction of the internal circuit at the time of rising or dropping to a lower value of power supply voltage. If the  $V_{IN}$  voltage becomes lower than 0.26V (Typ), the DC/DC converter is turned off. In order to cancel UVLO of  $V_{IN}$ , it is necessary to set  $V_{IN}$  more than 0.9V (Typ).

### 4. Over voltage protection (OVP)

BU33UV7NUX turns off the switching operation when the  $V_{OUT}$  voltage becomes over OVPD. At that time, the  $V_{OUT}$  pin is not discharge (in the case that the FB pin is shorted to  $V_{OUT}$ ). If the  $V_{OUT}$  voltage becomes less than OVPD, movement returns it.

### 5. Over current protection (OCP)

BU33UV7NUX has the function to limit the switching current.

OCP detector is active during low side MOSFET is in ON state.

When the heavy load is connected such that the peak of switching current  $I_{peak}$  is above OCP threshold, OCP function becomes active. ON-time of low side MOSFET is limited so that  $I_{peak}$  does not exceed OCP threshold, and  $V_{OUT}$  voltage decreases.

### 6. Short circuit protection (SCP)

BU33UV7NUX has Short Current Protect function.

SCP is detected when the  $V_{OUT}$  voltage becomes lower than  $V_{IN} - 0.750V$  (Typ). At that moment, the switching operation is turned off and limited the current.

Then, the device starts the Soft Start operation for reboot without distinction of the value of the load resistance. If the  $V_{OUT}$  pin is shorted to GND or the heavy load exceeding the specification value, the device keeps Current restriction state.

## Detailed Description - continued

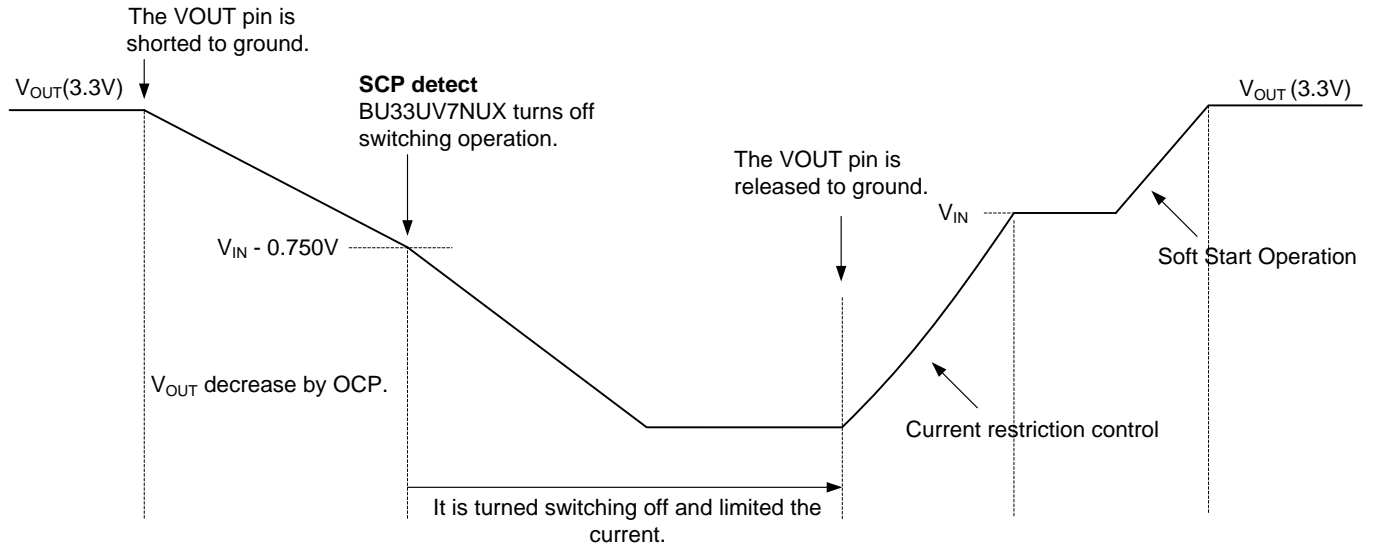

Figure 29. Output Voltage in SCP Operation

## 7. Thermal Shutdown (TSD)

BU33UV7NUX turns off the switching operation when the device temperature exceeds the threshold value for the device protection. After the device temperature falls below the threshold value, the device starts the Soft Start operation.

## 8. Function Select by MODE pin

With the MODE pin, the BU33UV7NUX provides mode selection of PFM control or PFM/PWM automatic switching control. When load current is large, the product switches automatically to the PWM mode so that high efficiency is achievable over a wide range of load conditions.

BU33UV7NUX operates under forced PWM mode to lower the output ripple when the Input-Output voltage difference is small at  $V_{IN}=3.2V$  to  $3.4V$ .

The operation current increases when running at forced PWM mode.

Selection of Components Externally Connected

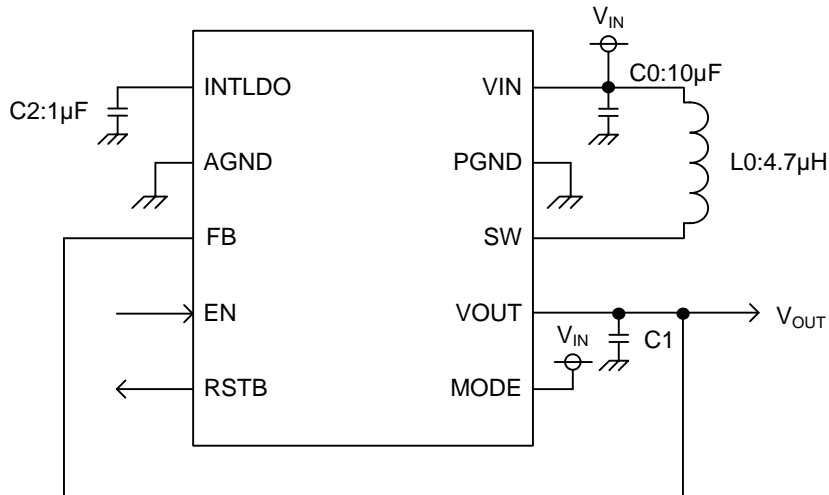

Figure 30. Typical Application Circuit (PFM/PWM mode)

Table 1. Components for Application Characteristic Curves

Name	Type	Value	Area	Height (Max)	Rated Voltage	Parts Number	Manufacturer
BU33UV7NUX	Boost Converter	3.3V	3mm×2mm	0.6mm	7V	BU33UV7NUX-E2	ROHM
C0	Capacitor	10µF	2mm×1.25mm	0.85mm	16V	EMK212ABJ106KD-T	TAIYO YUDEN
C1 <sup>(Note 1)</sup>	Capacitor	22µF	2mm×1.25mm	1.25mm	25V	GRM21BR61E226ME44L	muRata
	Capacitor	22µF×2	2mm×1.25mm	1.25mm	25V	GRM21BR61E226ME44L	muRata
C2	Capacitor	1µF	1.6mm×0.8mm	0.8mm	16V	C1608X5R1C105K080AA	TDK
L0	Inductor	4.7µH	5mm×4mm	1.5mm	-	VLF504015MT-4R7M	TDK

(Note 1) The effective load capacitance value considering accuracy, temperature characteristic and DC bias characteristic of output capacitors should not be less than 22µF. The amount of output capacitance will have a significant effect on the output ripple voltage.

Layout Example

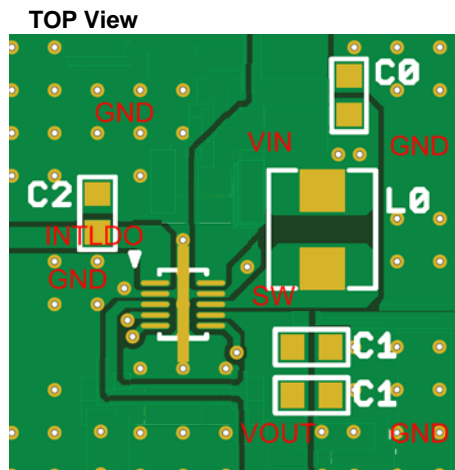

Figure 31. Reference Board Layout (TOP Layer)

## Application Information

### 1. Inductor Selection

Inductor value of 4.7μH shows good performance over the whole input and output voltage range.  
The maximum value of inductor current ( $I_{peak}$ ) can be estimated by using the following Equations.

$$I_{peak} = I_{out} \times \left( \frac{V_{out}}{V_{in} \times \eta} \right) + \left( \frac{\Delta I_L}{2} \right) \quad (1)$$

$$\Delta I_L = \left( \frac{V_{in}}{L} \right) \times \left( \frac{V_{out} - V_{in}}{V_{out}} \right) \times \left( \frac{1}{f} \right) \quad (2)$$

Where:

$\eta$  is the efficiency.

$\Delta I_L$  is the ripple Voltage.

$f$  is switching frequency.

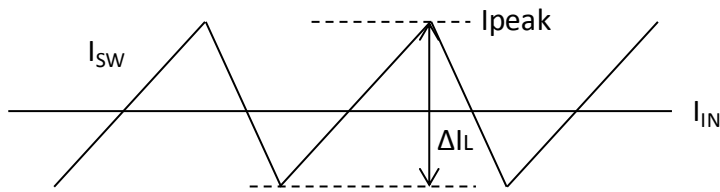

Figure 32. Switching Current

The inductor should be selected as satisfying above  $I_{peak}$  value.

I/O Equivalence Circuits

Pin Name	Equivalence circuit	Pin Name	Equivalence circuit
EN MODE		FB	
RSTB		VOUT	
SW		PGND	
INTLDO		VIN	

## Operational Notes

### 1. Reverse Connection of Power Supply

Connecting the power supply in reverse polarity can damage the IC. Take precautions against reverse polarity when connecting the power supply, such as mounting an external diode between the power supply and the IC's power supply pins.

### 2. Power Supply Lines

Design the PCB layout pattern to provide low impedance supply lines. Furthermore, connect a capacitor to ground at all power supply pins. Consider the effect of temperature and aging on the capacitance value when using electrolytic capacitors.

### 3. Ground Voltage

Ensure that no pins are at a voltage below that of the ground pin at any time, even during transient condition.

### 4. Ground Wiring Pattern

When using both small-signal and large-current ground traces, the two ground traces should be routed separately but connected to a single ground at the reference point of the application board to avoid fluctuations in the small-signal ground caused by large currents. Also ensure that the ground traces of external components do not cause variations on the ground voltage. The ground lines must be as short and thick as possible to reduce line impedance.

### 5. Recommended Operating Conditions

The function and operation of the IC are guaranteed within the range specified by the recommended operating conditions. The characteristic values are guaranteed only under the conditions of each item specified by the electrical characteristics.

### 6. Inrush Current

When power is first supplied to the IC, it is possible that the internal logic may be unstable and inrush current may flow instantaneously due to the internal powering sequence and delays, especially if the IC has more than one power supply. Therefore, give special consideration to power coupling capacitance, power wiring, width of ground wiring, and routing of connections.

### 7. Operation Under Strong Electromagnetic Field

Operating the IC in the presence of a strong electromagnetic field may cause the IC to malfunction.

### 8. Testing on Application Boards

When testing the IC on an application board, connecting a capacitor directly to a low-impedance output pin may subject the IC to stress. Always discharge capacitors completely after each process or step. The IC's power supply should always be turned off completely before connecting or removing it from the test setup during the inspection process. To prevent damage from static discharge, ground the IC during assembly and use similar precautions during transport and storage.

### 9. Inter-pin Short and Mounting Errors

Ensure that the direction and position are correct when mounting the IC on the PCB. Incorrect mounting may result in damaging the IC. Avoid nearby pins being shorted to each other especially to ground, power supply and output pin. Inter-pin shorts could be due to many reasons such as metal particles, water droplets (in very humid environment) and unintentional solder bridge deposited in between pins during assembly to name a few.

### 10. Unused Input Pins

Input pins of an IC are often connected to the gate of a MOS transistor. The gate has extremely high impedance and extremely low capacitance. If left unconnected, the electric field from the outside can easily charge it. The small charge acquired in this way is enough to produce a significant effect on the conduction through the transistor and cause unexpected operation of the IC. So unless otherwise specified, unused input pins should be connected to the power supply or ground line.

### 11. Regarding the Input Pin of the IC

In the construction of this IC, P-N junctions are inevitably formed creating parasitic diodes or transistors. The operation of these parasitic elements can result in mutual interference among circuits, operational faults, or physical damage. Therefore, conditions which cause these parasitic elements to operate, such as applying a voltage to an input pin lower than the ground voltage should be avoided. Furthermore, do not apply a voltage to the input pins when no power supply voltage is applied to the IC. Even if the power supply voltage is applied, make sure that the input pins have voltages within the values specified in the electrical characteristics of this IC.

**Operational Notes – continued****12. Ceramic Capacitor**

When using a ceramic capacitor, determine a capacitance value considering the change of capacitance with temperature and the decrease in nominal capacitance due to DC bias and others.

**13. Area of Safe Operation (ASO)**

Operate the IC such that the output voltage, output current, and the maximum junction temperature rating are all within the Area of Safe Operation (ASO).

**14. Thermal Shutdown Circuit(TSD)**

This IC has a built-in thermal shutdown circuit that prevents heat damage to the IC. Normal operation should always be within the IC's maximum junction temperature rating. If however the rating is exceeded for a continued period, the junction temperature ( $T_j$ ) will rise which will activate the TSD circuit that will turn OFF power output pins. When the  $T_j$  falls below the TSD threshold, the circuits are automatically restored to normal operation.

Note that the TSD circuit operates in a situation that exceeds the absolute maximum ratings and therefore, under no circumstances, should the TSD circuit be used in a set design or for any purpose other than protecting the IC from heat damage.

**15. Over Current Protection Circuit (OCP)**

This IC incorporates an integrated overcurrent protection circuit that is activated when the load is shorted. This protection circuit is effective in preventing damage due to sudden and unexpected incidents. However, the IC should not be used in applications characterized by continuous operation or transitioning of the protection circuit.

Ordering Information

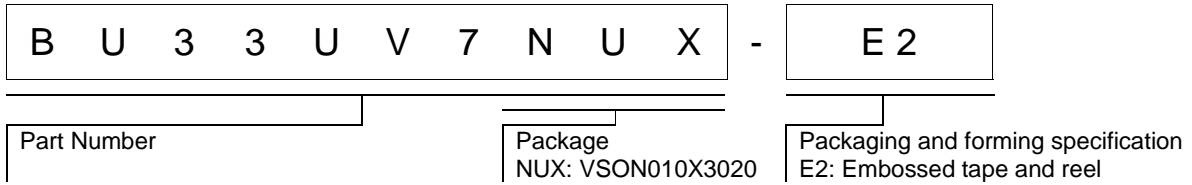

Marking Diagram

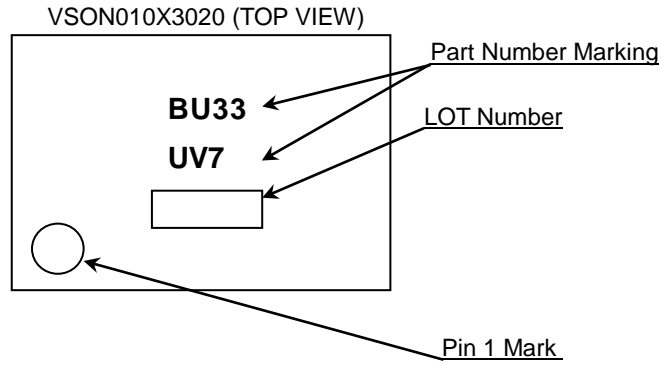

Physical Dimension and Packing Information

Package Name	VSON010X3020
--------------	--------------

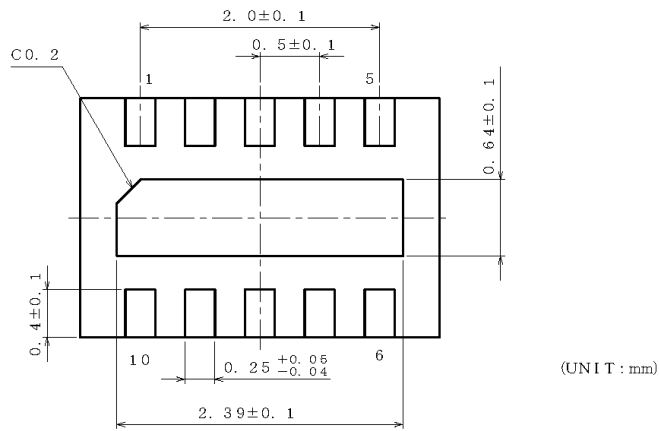
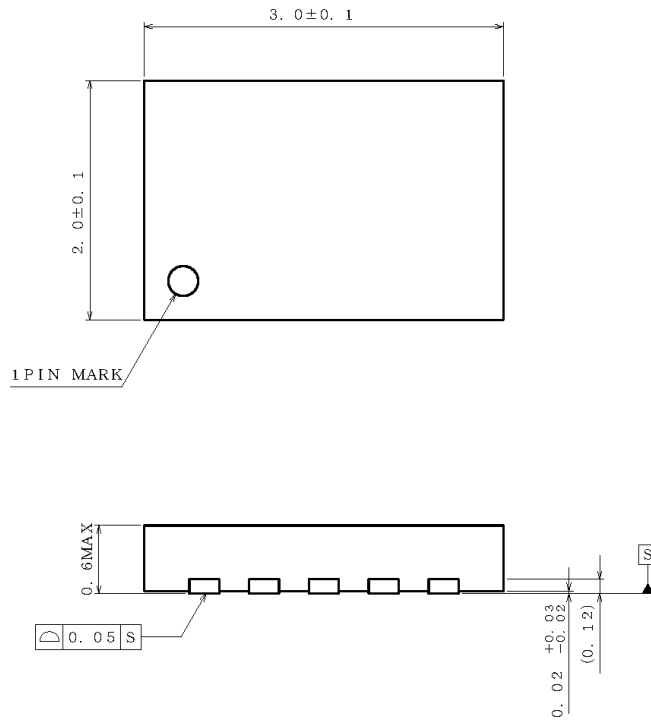

PKG: VSON010X3020  
Drawing No. EX190-5001

< Tape and Reel Information >

Tape	Embossed carrier tape
Quantity	4000pcs
Direction of feed	E2 The direction is the pin 1 of product is at the upper left when you hold reel on the left hand and you pull out the tape on the right hand

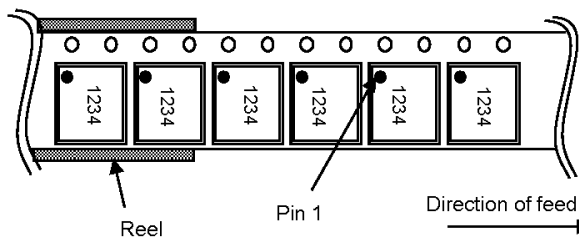

\*Order quantity needs to be multiple of the minimum quantity.

## Revision History

Date	Revision	Changes
18.Nov.2016	001	New Release
21.Aug.2018	002	P.1 Corrected the description "buck-boost->boost" P.1 Updated Figure 1 P.6 Updated Figure 12 P.7 Updated Figure 13 P.10 Updated Figure 27 P.13 Updated Figure 30
21.Feb.2019	003	P.4 Added Parameter "Output Voltage MODE=L"

# Notice

## Precaution on using ROHM Products

- Our Products are designed and manufactured for application in ordinary electronic equipment (such as AV equipment, OA equipment, telecommunication equipment, home electronic appliances, amusement equipment, etc.). If you intend to use our Products in devices requiring extremely high reliability (such as medical equipment <sup>(Note 1)</sup>, transport equipment, traffic equipment, aircraft/spacecraft, nuclear power controllers, fuel controllers, car equipment including car accessories, safety devices, etc.) and whose malfunction or failure may cause loss of human life, bodily injury or serious damage to property ("Specific Applications"), please consult with the ROHM sales representative in advance. Unless otherwise agreed in writing by ROHM in advance, ROHM shall not be in any way responsible or liable for any damages, expenses or losses incurred by you or third parties arising from the use of any ROHM's Products for Specific Applications.

(Note1) Medical Equipment Classification of the Specific Applications

JAPAN	USA	EU	CHINA
CLASS III	CLASS III	CLASS II b	CLASS III
CLASS IV		CLASS III	

- ROHM designs and manufactures its Products subject to strict quality control system. However, semiconductor products can fail or malfunction at a certain rate. Please be sure to implement, at your own responsibilities, adequate safety measures including but not limited to fail-safe design against the physical injury, damage to any property, which a failure or malfunction of our Products may cause. The following are examples of safety measures:
  - Installation of protection circuits or other protective devices to improve system safety
  - Installation of redundant circuits to reduce the impact of single or multiple circuit failure
- Our Products are designed and manufactured for use under standard conditions and not under any special or extraordinary environments or conditions, as exemplified below. Accordingly, ROHM shall not be in any way responsible or liable for any damages, expenses or losses arising from the use of any ROHM's Products under any special or extraordinary environments or conditions. If you intend to use our Products under any special or extraordinary environments or conditions (as exemplified below), your independent verification and confirmation of product performance, reliability, etc. prior to use, must be necessary:
  - Use of our Products in any types of liquid, including water, oils, chemicals, and organic solvents
  - Use of our Products outdoors or in places where the Products are exposed to direct sunlight or dust
  - Use of our Products in places where the Products are exposed to sea wind or corrosive gases, including Cl<sub>2</sub>, H<sub>2</sub>S, NH<sub>3</sub>, SO<sub>2</sub>, and NO<sub>2</sub>
  - Use of our Products in places where the Products are exposed to static electricity or electromagnetic waves
  - Use of our Products in proximity to heat-producing components, plastic cords, or other flammable items
  - Sealing or coating our Products with resin or other coating materials
  - Use of our Products without cleaning residue of flux (Exclude cases where no-clean type fluxes is used. However, recommend sufficiently about the residue.) ; or Washing our Products by using water or water-soluble cleaning agents for cleaning residue after soldering
  - Use of the Products in places subject to dew condensation
- The Products are not subject to radiation-proof design.
- Please verify and confirm characteristics of the final or mounted products in using the Products.
- In particular, if a transient load (a large amount of load applied in a short period of time, such as pulse, is applied, confirmation of performance characteristics after on-board mounting is strongly recommended. Avoid applying power exceeding normal rated power; exceeding the power rating under steady-state loading condition may negatively affect product performance and reliability.
- De-rate Power Dissipation depending on ambient temperature. When used in sealed area, confirm that it is the use in the range that does not exceed the maximum junction temperature.
- Confirm that operation temperature is within the specified range described in the product specification.
- ROHM shall not be in any way responsible or liable for failure induced under deviant condition from what is defined in this document.

## Precaution for Mounting / Circuit board design

- When a highly active halogenous (chlorine, bromine, etc.) flux is used, the residue of flux may negatively affect product performance and reliability.
- In principle, the reflow soldering method must be used on a surface-mount products, the flow soldering method must be used on a through hole mount products. If the flow soldering method is preferred on a surface-mount products, please consult with the ROHM representative in advance.

For details, please refer to ROHM Mounting specification

### Precautions Regarding Application Examples and External Circuits

1. If change is made to the constant of an external circuit, please allow a sufficient margin considering variations of the characteristics of the Products and external components, including transient characteristics, as well as static characteristics.
2. You agree that application notes, reference designs, and associated data and information contained in this document are presented only as guidance for Products use. Therefore, in case you use such information, you are solely responsible for it and you must exercise your own independent verification and judgment in the use of such information contained in this document. ROHM shall not be in any way responsible or liable for any damages, expenses or losses incurred by you or third parties arising from the use of such information.

### Precaution for Electrostatic

This Product is electrostatic sensitive product, which may be damaged due to electrostatic discharge. Please take proper caution in your manufacturing process and storage so that voltage exceeding the Products maximum rating will not be applied to Products. Please take special care under dry condition (e.g. Grounding of human body / equipment / solder iron, isolation from charged objects, setting of Ionizer, friction prevention and temperature / humidity control).

### Precaution for Storage / Transportation

1. Product performance and soldered connections may deteriorate if the Products are stored in the places where:
  - [a] the Products are exposed to sea winds or corrosive gases, including Cl<sub>2</sub>, H<sub>2</sub>S, NH<sub>3</sub>, SO<sub>2</sub>, and NO<sub>2</sub>
  - [b] the temperature or humidity exceeds those recommended by ROHM
  - [c] the Products are exposed to direct sunshine or condensation
  - [d] the Products are exposed to high Electrostatic
2. Even under ROHM recommended storage condition, solderability of products out of recommended storage time period may be degraded. It is strongly recommended to confirm solderability before using Products of which storage time is exceeding the recommended storage time period.
3. Store / transport cartons in the correct direction, which is indicated on a carton with a symbol. Otherwise bent leads may occur due to excessive stress applied when dropping of a carton.
4. Use Products within the specified time after opening a humidity barrier bag. Baking is required before using Products of which storage time is exceeding the recommended storage time period.

### Precaution for Product Label

A two-dimensional barcode printed on ROHM Products label is for ROHM's internal use only.

### Precaution for Disposition

When disposing Products please dispose them properly using an authorized industry waste company.

### Precaution for Foreign Exchange and Foreign Trade act

Since concerned goods might be fallen under listed items of export control prescribed by Foreign exchange and Foreign trade act, please consult with ROHM in case of export.

### Precaution Regarding Intellectual Property Rights

1. All information and data including but not limited to application example contained in this document is for reference only. ROHM does not warrant that foregoing information or data will not infringe any intellectual property rights or any other rights of any third party regarding such information or data.
2. ROHM shall not have any obligations where the claims, actions or demands arising from the combination of the Products with other articles such as components, circuits, systems or external equipment (including software).
3. No license, expressly or implied, is granted hereby under any intellectual property rights or other rights of ROHM or any third parties with respect to the Products or the information contained in this document. Provided, however, that ROHM will not assert its intellectual property rights or other rights against you or your customers to the extent necessary to manufacture or sell products containing the Products, subject to the terms and conditions herein.

### Other Precaution



1. This document may not be reprinted or reproduced, in whole or in part, without prior written consent of ROHM.
2. The Products may not be disassembled, converted, modified, reproduced or otherwise changed without prior written consent of ROHM.
3. In no event shall you use in any way whatsoever the Products and the related technical information contained in the Products or this document for any military purposes, including but not limited to, the development of mass-destruction weapons.
4. The proper names of companies or products described in this document are trademarks or registered trademarks of ROHM, its affiliated companies or third parties.

**General Precaution**

1. Before you use our Products, you are requested to carefully read this document and fully understand its contents. ROHM shall not be in any way responsible or liable for failure, malfunction or accident arising from the use of any ROHM's Products against warning, caution or note contained in this document.
2. All information contained in this document is current as of the issuing date and subject to change without any prior notice. Before purchasing or using ROHM's Products, please confirm the latest information with a ROHM sales representative.
3. The information contained in this document is provided on an "as is" basis and ROHM does not warrant that all information contained in this document is accurate and/or error-free. ROHM shall not be in any way responsible or liable for any damages, expenses or losses incurred by you or third parties resulting from inaccuracy or errors of or concerning such information.

## Looking for pricing, stock, or lifecycle information?

Click below to explore more details on WIN SOURCE:

-  [View BU33UV7NUX-E2 on WIN SOURCE](#)
-  [Rohm Semiconductor](#) Information

## Optimize Your Supply Chain with WIN SOURCE Solutions

-  Global Sourcing Solution
-  Obsolete Management
-  Cost Control Management
-  Shortage Management
-  Alternative Solution
-  Excess Inventory Management