



THE DATASHEET OF NVTFS4C06NTAG



MOSFET – Power, Single, N-Channel, μ 8FL

30 V, 71 A, 4.2 m Ω

NVTFS4C06N

Features

- Low $R_{DS(on)}$ to Minimize Conduction Losses
- Low Capacitance to Minimize Driver Losses
- Optimized Gate Charge to Minimize Switching Losses
- NVTFS4C06NWF – Wettable Flanks Product
- NVT Prefix for Automotive and Other Applications Requiring Unique Site and Control Change Requirements; AEC-Q101 Qualified and PPAP Capable
- These Devices are Pb-Free, Halogen Free/BFR Free and are RoHS Compliant

MAXIMUM RATINGS ($T_J = 25^\circ\text{C}$ unless otherwise stated)

Symbol	Parameter	Value	Unit
V_{DSS}	Drain-to-Source Voltage	30	V
V_{GS}	Gate-to-Source Voltage	± 20	V
I_D	Continuous Drain Current $R_{\theta JA}$ (Notes 1, 2, 4)	Steady State $T_A = 25^\circ\text{C}$	21
		$T_A = 100^\circ\text{C}$	15
P_D	Power Dissipation $R_{\theta JA}$ (Note 1, 2, 4)	$T_A = 25^\circ\text{C}$	3.1
		$T_A = 100^\circ\text{C}$	1.6
I_D	Continuous Drain Current $R_{\theta JC}$ (Note 1, 3, 4)	$T_A = 25^\circ\text{C}$	71
		$T_A = 100^\circ\text{C}$	50
P_D	Power Dissipation $R_{\theta JC}$ (Note 1, 3, 4)	$T_A = 25^\circ\text{C}$	37
		$T_A = 100^\circ\text{C}$	18
I_{DM}	Pulsed Drain Current $T_A = 25^\circ\text{C}, t_p = 10 \mu\text{s}$	367	A
T_J, T_{stg}	Operating Junction and Storage Temperature	-55 to +175	$^\circ\text{C}$
I_S	Source Current (Body Diode)	33	A
E_{AS}	Single Pulse Drain-to-Source Avalanche Energy ($T_J = 25^\circ\text{C}, I_L = 26 A_{pk}, L = 0.1 \text{ mH}$)	34	mJ
T_L	Lead Temperature for Soldering Purposes (1/8" from Case for 10 s)	260	$^\circ\text{C}$

Stresses exceeding those listed in the Maximum Ratings table may damage the device. If any of these limits are exceeded, device functionality should not be assumed, damage may occur and reliability may be affected.

$V_{(BR)DSS}$	$R_{DS(on)}$ MAX	I_D MAX
30 V	4.2 m Ω @ 10 V	71 A
	6.1 m Ω @ 4.5 V	



WDFN8 3.3x3.3, 0.65P
CASE 511AB



WDFNW8 3.3x3.3, 0.65P (Full-Cut μ 8FL WF)
CASE 515AN

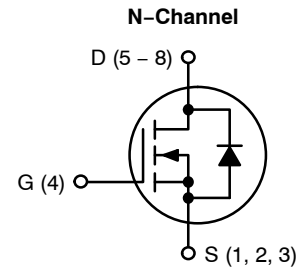

MARKING DIAGRAM

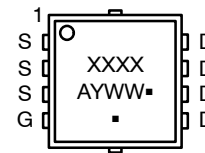

- 4C06 = Specific Device Code for NVMTS4C06N
- 06WF = Specific Device Code of NVTFS4C06NWF
- A = Assembly Location
- Y = Year
- WW = Work Week
- = Pb-Free Package

(Note: Microdot may be in either location)

ORDERING INFORMATION

See detailed ordering, marking and shipping information on page 6 of this data sheet.

NOTE: Some of the devices on this data sheet have been **DISCONTINUED**. Please refer to the table on page 6.

NVTFS4C06N

THERMAL RESISTANCE MAXIMUM RATINGS

Symbol	Parameter	Value	Unit
$R_{\theta JC}$	Junction-to-Case – Steady State (Drain) (Notes 1 and 4)	4.1	$^{\circ}C/W$
$R_{\theta JA}$	Junction-to-Ambient – Steady State (Notes 1 and 2)	48	

1. The entire application environment impacts the thermal resistance values shown, they are not constants and are only valid for the particular conditions noted.
2. Surface-mounted on FR4 board using a 650 mm² 2 oz. Cu pad.
3. Assumes heat-sink sufficiently large to maintain constant case temperature independent of device power.
4. Continuous DC current rating. Maximum current for pulses as long as 1 second is higher but is dependent on pulse duration and duty cycle.

ELECTRICAL CHARACTERISTICS ($T_J = 25^{\circ}C$ unless otherwise specified)

Symbol	Parameter	Test Condition	Min	Typ	Max	Unit
--------	-----------	----------------	-----	-----	-----	------

OFF CHARACTERISTICS

$V_{(BR)DSS}$	Drain-to-Source Breakdown Voltage	$V_{GS} = 0 V, I_D = 250 \mu A$	30	–	–	V
$V_{(BR)DSS}/T_J$	Drain-to-Source Breakdown Voltage Temperature Coefficient		–	14.4	–	mV/ $^{\circ}C$
I_{DSS}	Zero Gate Voltage Drain Current	$V_{GS} = 0 V, V_{DS} = 24 V$				
		$T_J = 25^{\circ}C$	–	–	1.0	μA
		$T_J = 125^{\circ}C$	–	–	10	
I_{GSS}	Gate-to-Source Leakage Current	$V_{DS} = 0 V, V_{GS} = \pm 20 V$	–	–	± 100	nA

ON CHARACTERISTICS (Note 5)

$V_{GS(TH)}$	Gate Threshold Voltage	$V_{GS} = V_{DS}, I_D = 250 \mu A$	1.3	–	2.2	V
$V_{GS(TH)}/T_J$	Negative Threshold Temperature Coefficient		–	3.8	–	mV/ $^{\circ}C$
$R_{DS(on)}$	Drain-to-Source On Resistance	$V_{GS} = 10 V, I_D = 30 A$	–	3.4	4.2	m Ω
		$V_{GS} = 4.5 V, I_D = 30 A$	–	4.9	6.1	
g_{FS}	Forward Transconductance	$V_{DS} = 1.5 V, I_D = 15 A$	–	58	–	S
R_G	Gate Resistance	$T_A = 25^{\circ}C$	–	1.0	–	Ω

CHARGES AND CAPACITANCES

C_{ISS}	Input Capacitance	$V_{GS} = 0 V, f = 1 MHz, V_{DS} = 15 V$	–	1683	–	pF
C_{OSS}	Output Capacitance		–	841	–	
C_{RSS}	Reverse Transfer Capacitance		–	40	–	
C_{RSS}/C_{ISS}	Capacitance Ratio	$V_{GS} = 0 V, V_{DS} = 15 V, f = 1 MHz$	–	0.023	–	
$Q_{G(TOT)}$	Total Gate Charge	$V_{GS} = 4.5 V, V_{DS} = 15 V; I_D = 30 A$	–	11.6	–	nC
$Q_{G(TH)}$	Threshold Gate Charge		–	2.6	–	
Q_{GS}	Gate-to-Source Charge		–	4.7	–	
Q_{GD}	Gate-to-Drain Charge		–	4.0	–	
V_{GP}	Gate Plateau Voltage		–	3.1	–	V
$Q_{G(TOT)}$	Total Gate Charge	$V_{GS} = 10 V, V_{DS} = 15 V; I_D = 30 A$	–	26	–	nC

SWITCHING CHARACTERISTICS (Note 6)

$t_{d(ON)}$	Turn-On Delay Time	$V_{GS} = 4.5 V, V_{DS} = 15 V, I_D = 15 A, R_G = 3.0 \Omega$	–	10	–	ns
t_r	Rise Time		–	32	–	
$t_{d(OFF)}$	Turn-Off Delay Time		–	18	–	
t_f	Fall Time		–	5.0	–	
$t_{d(ON)}$	Turn-On Delay Time	$V_{GS} = 10 V, V_{DS} = 15 V, I_D = 15 A, R_G = 3.0 \Omega$	–	8.0	–	ns
t_r	Rise Time		–	28	–	
$t_{d(OFF)}$	Turn-Off Delay Time		–	24	–	
t_f	Fall Time		–	3.0	–	

NVTFS4C06N

ELECTRICAL CHARACTERISTICS ($T_J = 25^\circ\text{C}$ unless otherwise specified) (continued)

Symbol	Parameter	Test Condition	Min	Typ	Max	Unit	
DRAIN-SOURCE DIODE CHARACTERISTICS							
V_{SD}	Forward Diode Voltage	$V_{GS} = 0\text{ V}$, $I_S = 10\text{ A}$	$T_J = 25^\circ\text{C}$	-	0.8	1.1	V
			$T_J = 125^\circ\text{C}$	-	0.63	-	
t_{RR}	Reverse Recovery Time	$V_{GS} = 0\text{ V}$, $dI_S/dt = 100\text{ A}/\mu\text{s}$, $I_S = 30\text{ A}$	-	34	-	ns	
t_a	Charge Time		-	17	-		
t_b	Discharge Time		-	17	-		
Q_{RR}	Reverse Recovery Charge		-	22	-	nC	

Product parametric performance is indicated in the Electrical Characteristics for the listed test conditions, unless otherwise noted. Product performance may not be indicated by the Electrical Characteristics if operated under different conditions.

5. Pulse Test: pulse width $\leq 300\ \mu\text{s}$, duty cycle $\leq 2\%$.

6. Switching characteristics are independent of operating junction temperatures.

NVTFS4C06N

TYPICAL CHARACTERISTICS

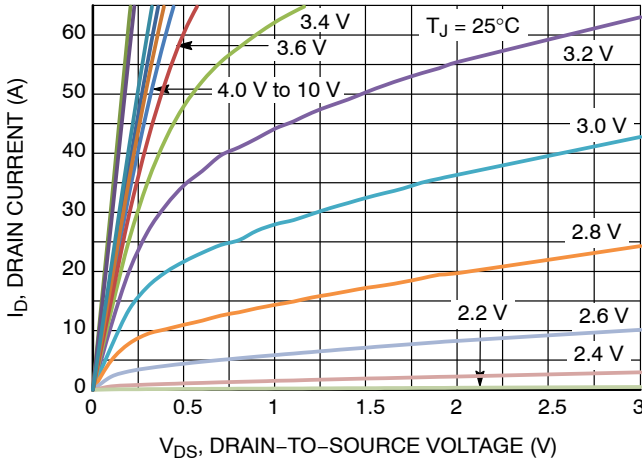

Figure 1. On-Region Characteristics

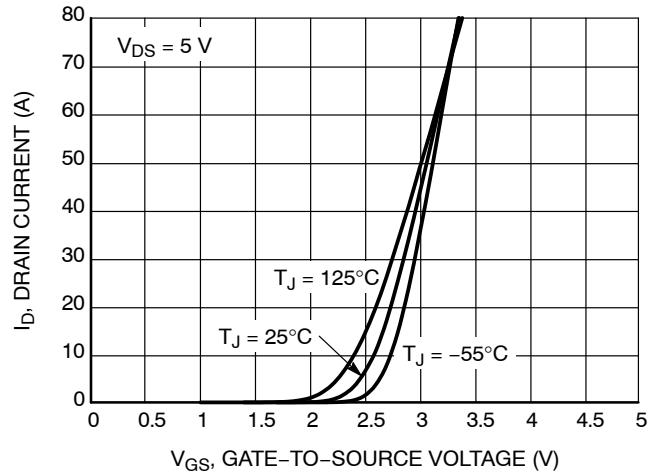

Figure 2. Transfer Characteristics

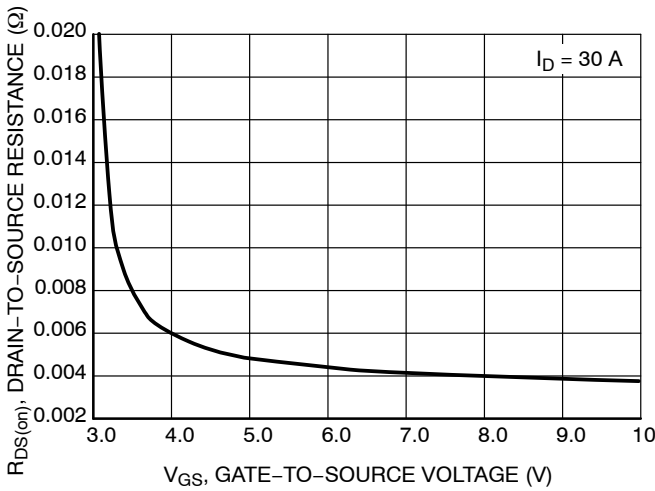

Figure 3. On-Resistance vs. V_{GS}

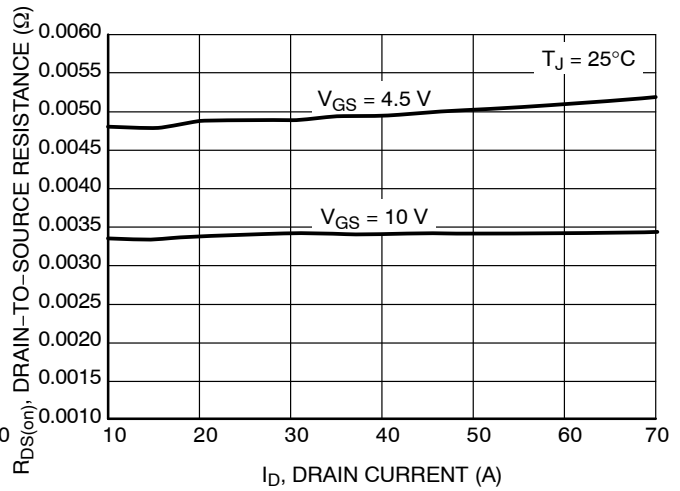

Figure 4. On-Resistance vs. Drain Current and Gate Voltage

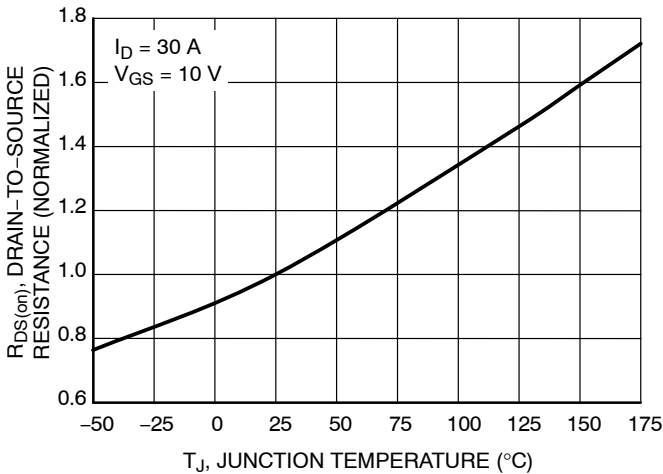

Figure 5. On-Resistance Variation with Temperature

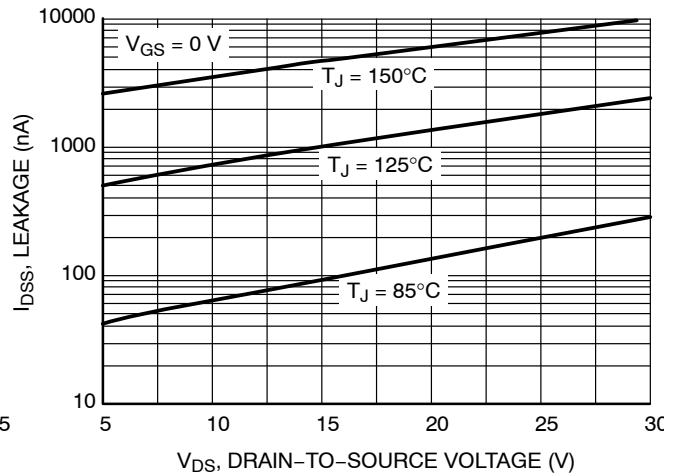

Figure 6. Drain-to-Source Leakage Current vs. Voltage

NVTFS4C06N

TYPICAL CHARACTERISTICS (continued)

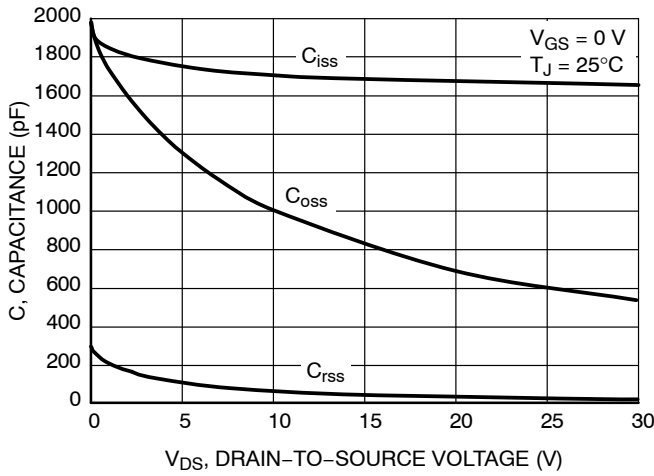

Figure 7. Capacitance Variation

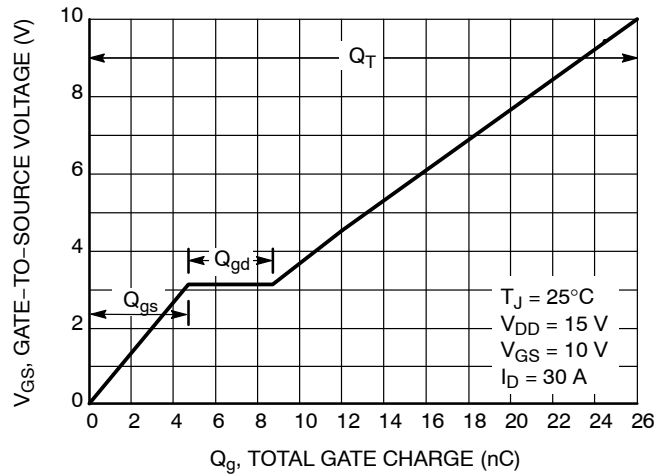

Figure 8. Gate-to-Source and Drain-to-Source Voltage vs. Total Charge

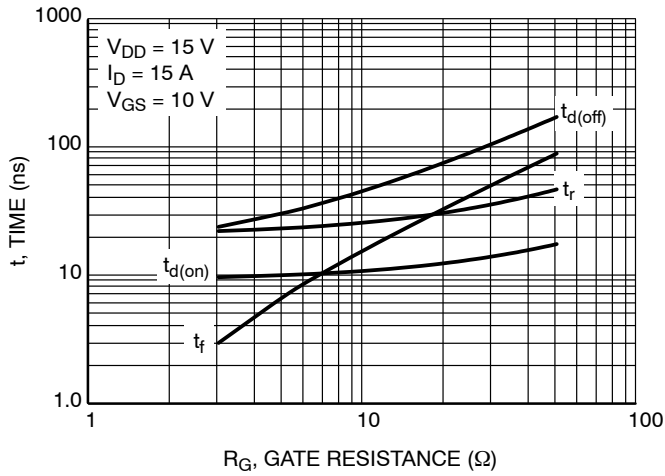

Figure 9. Resistive Switching Time Variation vs. Gate Resistance

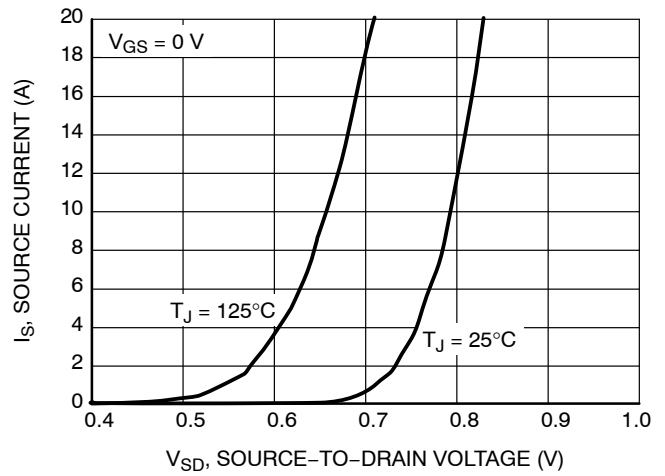

Figure 10. Diode Forward Voltage vs. Current

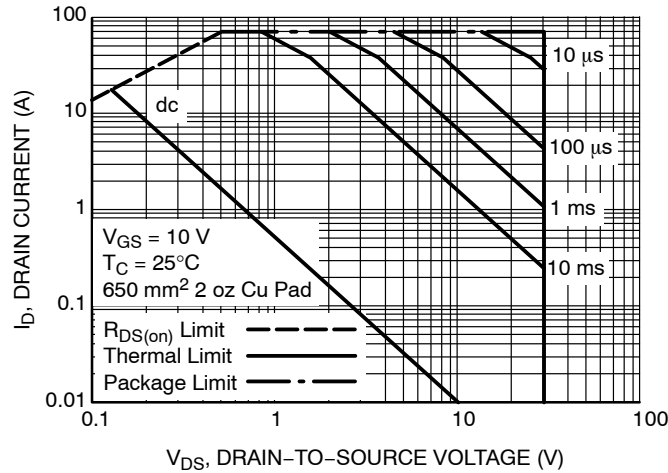

Figure 11. Maximum Rated Forward Biased Safe Operating Area

NVTFS4C06N

TYPICAL CHARACTERISTICS (continued)

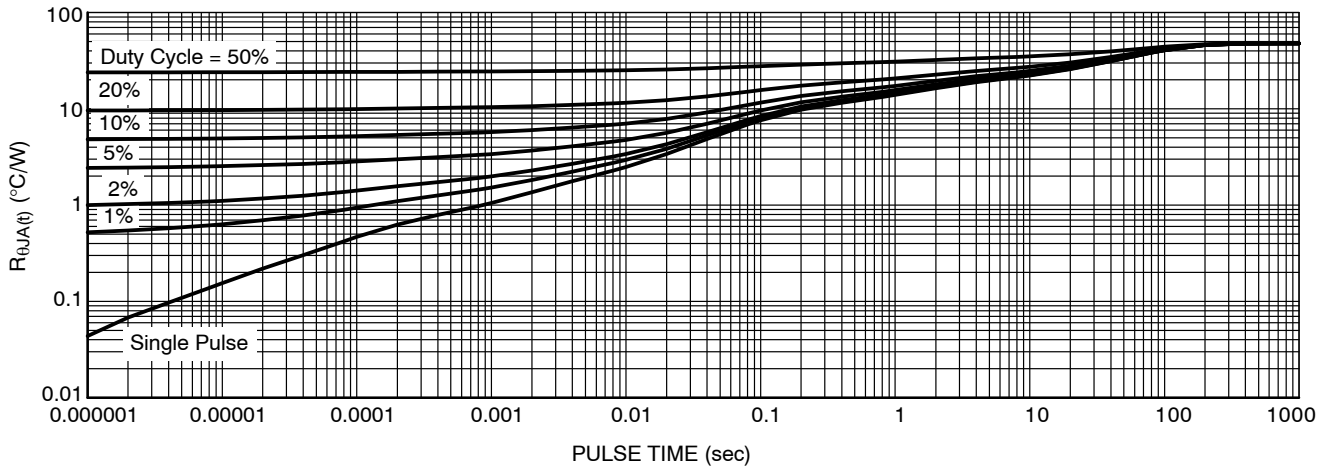

Figure 12. Thermal Response

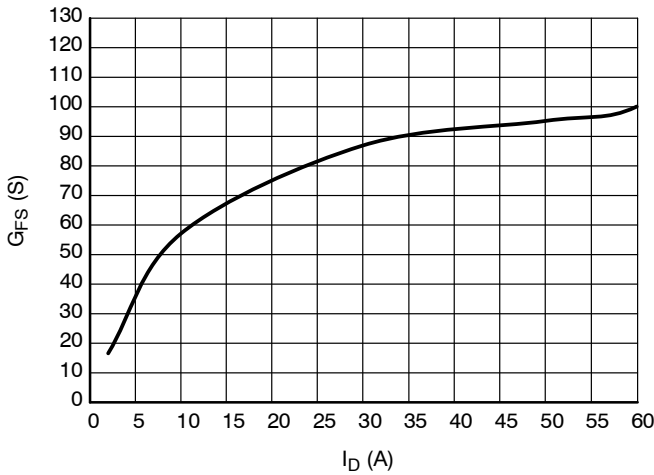

Figure 13. G_{FS} vs. I_D

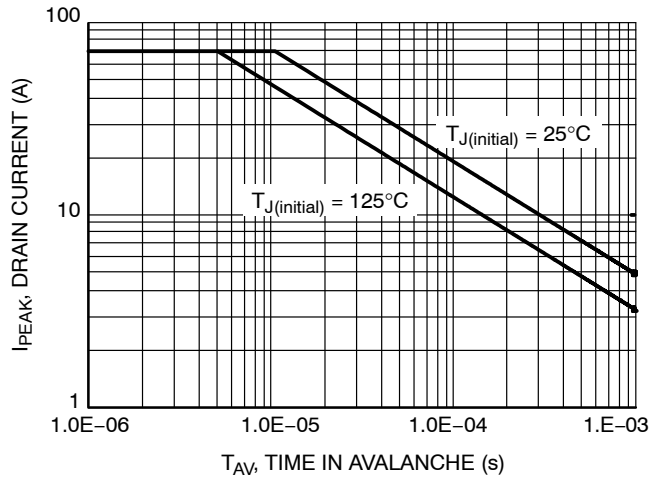

Figure 14. Avalanche Characteristics

ORDERING INFORMATION

Device	Package	Shipping†
NVTFS4C06NTAG	WDFN8 3.3x3.3, 0.65P (Pb-Free)	1500 / Tape & Reel
NVTFS4C06NTWG	WDFN8 3.3x3.3, 0.65P (Pb-Free)	5000 / Tape & Reel

DISCONTINUED (Note 7)

NVTFS4C06NWFTAG	WDFNW8 3.3x3.3, 0.65P (Full-Cut μ 8FL WF) (Pb-Free)	1500 / Tape & Reel
NVTFS4C06NWFTWG	WDFNW8 3.3x3.3, 0.65P (Full-Cut μ 8FL WF) (Pb-Free)	5000 / Tape & Reel

†For information on tape and reel specifications, including part orientation and tape sizes, please refer to our Tape and Reel Packaging Specifications Brochure, [BRD8011/D](#).

7. **DISCONTINUED:** These devices are not recommended for new design. Please contact your **onsemi** representative for information. The most current information on these devices may be available on www.onsemi.com.

MECHANICAL CASE OUTLINE PACKAGE DIMENSIONS



SCALE 2:1

WDFN8 3.3x3.3, 0.65P
CASE 511AB
ISSUE D

DATE 23 APR 2012

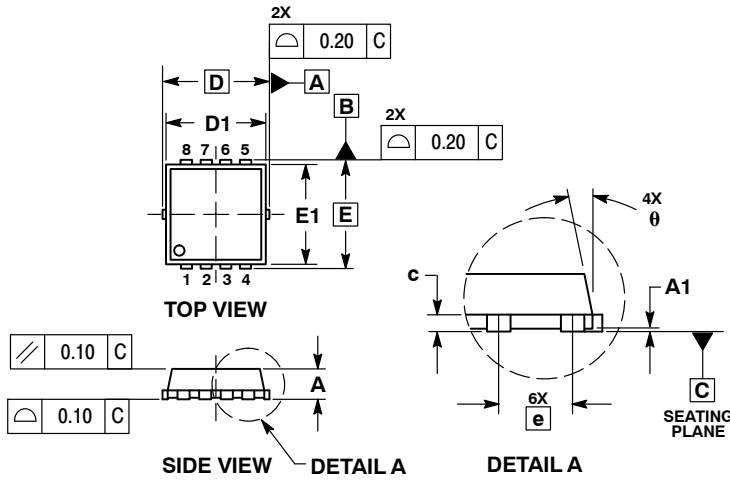

NOTES:

1. DIMENSIONING AND TOLERANCING PER ASME Y14.5M, 1994.
2. CONTROLLING DIMENSION: MILLIMETERS.
3. DIMENSION D1 AND E1 DO NOT INCLUDE MOLD FLASH PROTRUSIONS OR GATE BURRS.

DIM	MILLIMETERS			INCHES		
	MIN	NOM	MAX	MIN	NOM	MAX
A	0.70	0.75	0.80	0.028	0.030	0.031
A1	0.00	---	0.05	0.000	---	0.002
b	0.23	0.30	0.40	0.009	0.012	0.016
c	0.15	0.20	0.25	0.006	0.008	0.010
D	3.30 BSC			0.130 BSC		
D1	2.95	3.05	3.15	0.116	0.120	0.124
D2	1.98	2.11	2.24	0.078	0.083	0.088
E	3.30 BSC			0.130 BSC		
E1	2.95	3.05	3.15	0.116	0.120	0.124
E2	1.47	1.60	1.73	0.058	0.063	0.068
E3	0.23	0.30	0.40	0.009	0.012	0.016
e	0.65 BSC			0.026 BSC		
G	0.30	0.41	0.51	0.012	0.016	0.020
K	0.65	0.80	0.95	0.026	0.032	0.037
L	0.30	0.43	0.56	0.012	0.017	0.022
L1	0.06	0.13	0.20	0.002	0.005	0.008
M	1.40	1.50	1.60	0.055	0.059	0.063
θ	0°	---	12°	0°	---	12°

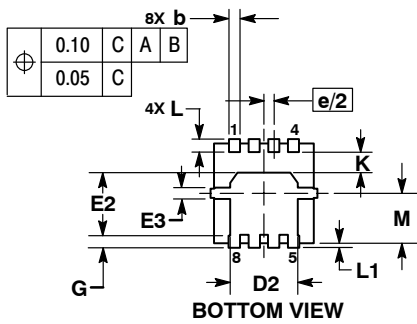

GENERIC MARKING DIAGRAM*

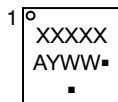

- XXXXX = Specific Device Code
- A = Assembly Location
- Y = Year
- WW = Work Week
- = Pb-Free Package

*This information is generic. Please refer to device data sheet for actual part marking. Pb-Free indicator, "G" or microdot "▪", may or may not be present. Some products may not follow the Generic Marking.

SOLDERING FOOTPRINT*

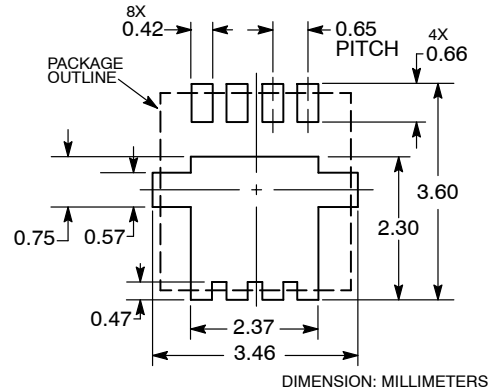

*For additional information on our Pb-Free strategy and soldering details, please download the ON Semiconductor Soldering and Mounting Techniques Reference Manual, SOLDERRM/D.

DOCUMENT NUMBER:	98AON30561E	Electronic versions are uncontrolled except when accessed directly from the Document Repository. Printed versions are uncontrolled except when stamped "CONTROLLED COPY" in red.
DESCRIPTION:	WDFN8 3.3X3.3, 0.65P	PAGE 1 OF 1

onsemi and ONSEMI are trademarks of Semiconductor Components Industries, LLC dba onsemi or its subsidiaries in the United States and/or other countries. onsemi reserves the right to make changes without further notice to any products herein. onsemi makes no warranty, representation or guarantee regarding the suitability of its products for any particular purpose, nor does onsemi assume any liability arising out of the application or use of any product or circuit, and specifically disclaims any and all liability, including without limitation special, consequential or incidental damages. onsemi does not convey any license under its patent rights nor the rights of others.

MECHANICAL CASE OUTLINE

PACKAGE DIMENSIONS

ON Semiconductor®

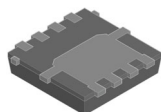

WDFNW8 3.3x3.3, 0.65P (Full-Cut μ 8FL WF) CASE 515AN ISSUE O

DATE 25 AUG 2020

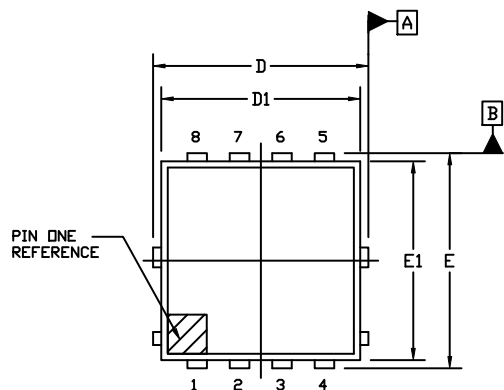

TOP VIEW

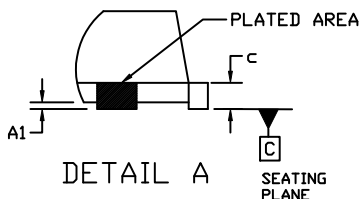

DETAIL A

NOTES:

1. DIMENSIONING AND TOLERANCING PER ASME Y14.5M, 2009.
2. CONTROLLING DIMENSION: MILLIMETERS
3. DIMENSION D1 AND E1 DO NOT INCLUDE MOLD FLASH, PROTRUSIONS, OR GATE BURRS.

DIM	MILLIMETERS		
	MIN.	NDM.	MAX.
A	0.70	0.75	0.80
A1	0.00	----	0.05
b	0.23	0.30	0.40
c	0.15	0.20	0.25
D	3.05	3.30	3.55
D1	2.95	3.05	3.15
D2	1.98	2.11	2.24
E	3.05	3.30	3.55
E1	2.95	3.05	3.15
E2	1.47	1.60	1.73
E3	0.23	0.30	0.40
e	0.65 BSC		
G	0.30	0.41	0.51
K	0.65	0.80	0.95
L	0.30	0.43	0.59
L1	0.06	0.13	0.20
M	1.40	1.50	1.60

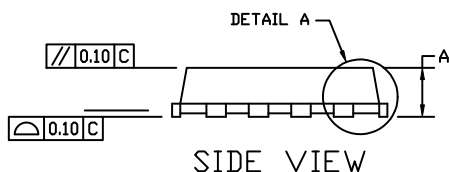

SIDE VIEW

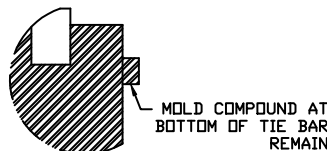

DETAIL B

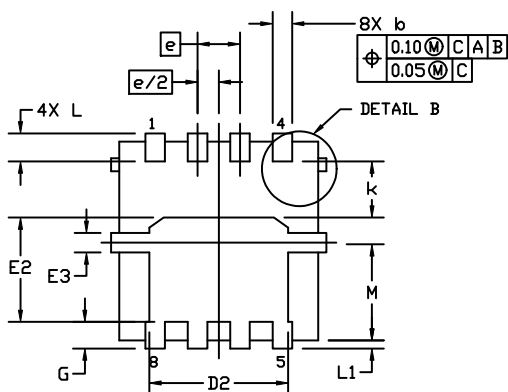

BOTTOM VIEW

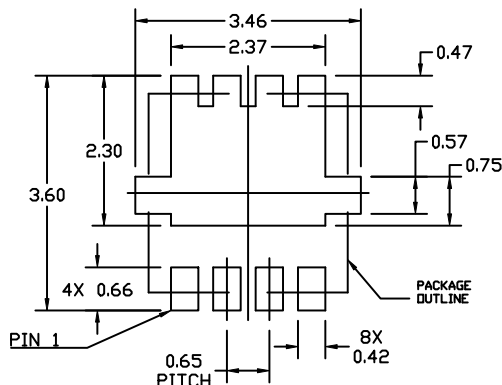

RECOMMENDED MOUNTING FOOTPRINT

* For additional information on our Pb-Free strategy and soldering details, please download the ON Semiconductor Soldering and Mounting Techniques Reference Manual, SOLDERRM/D.

GENERIC MARKING DIAGRAM*

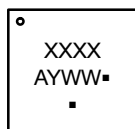

XXXX = Specific Device Code
 A = Assembly Location
 Y = Year
 WW = Work Week
 ■ = Pb-Free Package

*This information is generic. Please refer to device data sheet for actual part marking. Pb-Free indicator, "G" or microdot "■", may or may not be present. Some products may not follow the Generic Marking.

(Note: Microdot may be in either location)

DOCUMENT NUMBER:	98AON24556H	Electronic versions are uncontrolled except when accessed directly from the Document Repository. Printed versions are uncontrolled except when stamped "CONTROLLED COPY" in red.
DESCRIPTION:	WDFNW8 3.3x3.3, 0.65P (Full-Cut μ 8FL WF)	PAGE 1 OF 1

ON Semiconductor and are trademarks of Semiconductor Components Industries, LLC dba ON Semiconductor or its subsidiaries in the United States and/or other countries. ON Semiconductor reserves the right to make changes without further notice to any products herein. ON Semiconductor makes no warranty, representation or guarantee regarding the suitability of its products for any particular purpose, nor does ON Semiconductor assume any liability arising out of the application or use of any product or circuit, and specifically disclaims any and all liability, including without limitation special, consequential or incidental damages. ON Semiconductor does not convey any license under its patent rights nor the rights of others.

onsemi, **Onsemi**, and other names, marks, and brands are registered and/or common law trademarks of Semiconductor Components Industries, LLC dba "**onsemi**" or its affiliates and/or subsidiaries in the United States and/or other countries. **onsemi** owns the rights to a number of patents, trademarks, copyrights, trade secrets, and other intellectual property. A listing of **onsemi**'s product/patent coverage may be accessed at www.onsemi.com/site/pdf/Patent-Marking.pdf. **onsemi** reserves the right to make changes at any time to any products or information herein, without notice. The information herein is provided "as-is" and **onsemi** makes no warranty, representation or guarantee regarding the accuracy of the information, product features, availability, functionality, or suitability of its products for any particular purpose, nor does **onsemi** assume any liability arising out of the application or use of any product or circuit, and specifically disclaims any and all liability, including without limitation special, consequential or incidental damages. Buyer is responsible for its products and applications using **onsemi** products, including compliance with all laws, regulations and safety requirements or standards, regardless of any support or applications information provided by **onsemi**. "Typical" parameters which may be provided in **onsemi** data sheets and/or specifications can and do vary in different applications and actual performance may vary over time. All operating parameters, including "Typicals" must be validated for each customer application by customer's technical experts. **onsemi** does not convey any license under any of its intellectual property rights nor the rights of others. **onsemi** products are not designed, intended, or authorized for use as a critical component in life support systems or any FDA Class 3 medical devices or medical devices with a same or similar classification in a foreign jurisdiction or any devices intended for implantation in the human body. Should Buyer purchase or use **onsemi** products for any such unintended or unauthorized application, Buyer shall indemnify and hold **onsemi** and its officers, employees, subsidiaries, affiliates, and distributors harmless against all claims, costs, damages, and expenses, and reasonable attorney fees arising out of, directly or indirectly, any claim of personal injury or death associated with such unintended or unauthorized use, even if such claim alleges that **onsemi** was negligent regarding the design or manufacture of the part. **onsemi** is an Equal Opportunity/Affirmative Action Employer. This literature is subject to all applicable copyright laws and is not for resale in any manner.

ADDITIONAL INFORMATION

TECHNICAL PUBLICATIONS:

Technical Library: www.onsemi.com/design/resources/technical-documentation
onsemi Website: www.onsemi.com

ONLINE SUPPORT: www.onsemi.com/support

For additional information, please contact your local Sales Representative at www.onsemi.com/support/sales

Looking for pricing, stock, or lifecycle information?

Click below to explore more details on WIN SOURCE:

 [View NVTFS4C06NTAG on WIN SOURCE](#)

 [ON Semiconductor](#) Information

Optimize Your Supply Chain with WIN SOURCE Solutions

-  Global Sourcing Solution
-  Obsolete Management
-  Cost Control Management
-  Shortage Management
-  Alternative Solution
-  Excess Inventory Management