



# THE DATASHEET OF NUP6012PMUTAG



# NUP6012PMU

## Six-Line Transient Voltage Suppressor Array

### ESD Protection Diodes with Ultra-Low (0.7 pF) Capacitance

The six-line voltage transient suppressor array is designed to protect voltage-sensitive components that require ultra-low capacitance from ESD and transient voltage events. This device features a common anode design which protects six independent high speed data lines in a single six-lead UDFN low profile package.

Excellent clamping capability, low capacitance, low leakage, and fast response time make these parts ideal for ESD protection on designs where board space is at a premium. Because of its low capacitance, it is suited for use in high frequency designs.

#### Features

- Low Capacitance Data Lines (0.7 pF Typical)
- Protects up to Six Data Lines
- UDFN Package, 1.6 x 1.6 mm
- Low Profile of 0.50 mm for Ultra Slim Design
- ESD Rating: IEC61000-4-2: Level 4  
– Contact (14 kV)
- D<sub>1</sub>, D<sub>2</sub>, D<sub>3</sub>, D<sub>4</sub>, D<sub>5</sub> and D<sub>6</sub> Pins = 5.2 V Minimum Protection
- RoHS Compliant
- This is a Pb-Free Device

#### Typical Applications

- USB 2.0 High-Speed Interface
- Cell Phones
- MP3 Players
- SIM Card Protection

#### MAXIMUM RATINGS (T<sub>J</sub> = 25°C, unless otherwise specified)

Symbol	Rating	Value	Unit
T <sub>J</sub>	Operating Junction Temperature Range	-40 to 125	°C
T <sub>STG</sub>	Storage Temperature Range	-55 to 150	°C
T <sub>L</sub>	Lead Solder Temperature – Maximum (10 seconds)	260	°C
ESD	IEC 61000-4-2 Contact	14000	V

Stresses exceeding Maximum Ratings may damage the device. Maximum Ratings are stress ratings only. Functional operation above the Recommended Operating Conditions is not implied. Extended exposure to stresses above the Recommended Operating Conditions may affect device reliability.



ON Semiconductor®

<http://onsemi.com>

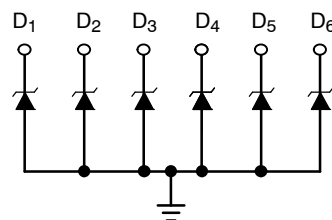

#### MARKING DIAGRAM



UDFN6 1.6x1.6  
MU SUFFIX  
CASE 517AP

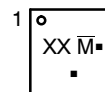

- XX = Specific Device Code
- M̄ = Date Code
- = Pb-Free Package

(Note: Microdot may be in either location)

#### PIN CONNECTIONS

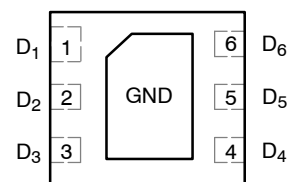

#### ORDERING INFORMATION

Device	Package	Shipping†
NUP6012PMUTAG	UDFN6 (Pb-Free)	3000/Tape & Reel

† For information on tape and reel specifications, including part orientation and tape sizes, please refer to our Tape and Reel Packaging Specification Brochure, BRD8011/D.

# NUP6012PMU

## ELECTRICAL CHARACTERISTICS

( $T_A = 25^\circ\text{C}$  unless otherwise noted)

Symbol	Parameter
$I_{PP}$	Maximum Reverse Peak Pulse Current
$V_C$	Clamping Voltage @ $I_{PP}$
$V_{RWM}$	Working Peak Reverse Voltage
$I_R$	Maximum Reverse Leakage Current @ $V_{RWM}$
$V_{BR}$	Breakdown Voltage @ $I_T$
$I_T$	Test Current
$I_F$	Forward Current
$V_F$	Forward Voltage @ $I_F$
$P_{pk}$	Peak Power Dissipation
C	Max. Capacitance @ $V_R = 0$ and $f = 1.0$ MHz

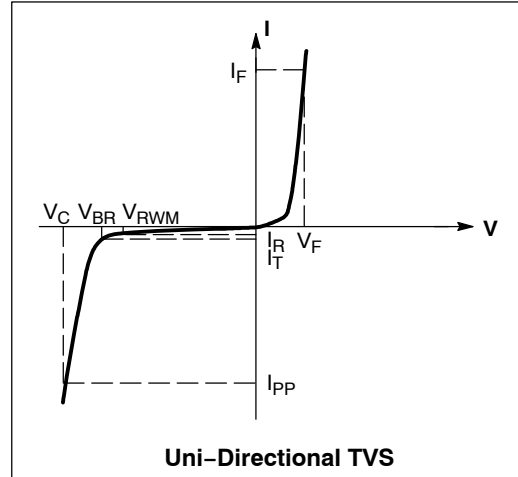

## ELECTRICAL CHARACTERISTICS ( $T_J = 25^\circ\text{C}$ , unless otherwise specified)

Parameter	Conditions	Symbol	Min	Typ	Max	Unit
Reverse Working Voltage (D <sub>1</sub> , D <sub>2</sub> , D <sub>3</sub> , D <sub>4</sub> , D <sub>5</sub> and D <sub>6</sub> )	(Note 1)	$V_{RWM}$	-	-	4.0	V
Breakdown Voltage (D <sub>1</sub> , D <sub>2</sub> , D <sub>3</sub> , D <sub>4</sub> , D <sub>5</sub> and D <sub>6</sub> )	$I_T = 1$ mA, (Note 2)	$V_{BR}$	5.2	5.5	-	V
Reverse Leakage Current (D <sub>1</sub> , D <sub>2</sub> , D <sub>3</sub> , D <sub>4</sub> , D <sub>5</sub> and D <sub>6</sub> )	@ $V_{RWM}$	$I_R$	-	-	1.0	$\mu\text{A}$
Capacitance (D <sub>1</sub> , D <sub>2</sub> , D <sub>3</sub> , D <sub>4</sub> , D <sub>5</sub> and D <sub>6</sub> )	$V_R = 0$ V, $f = 1$ MHz (Line to GND)	$C_J$	-	0.7	0.9	pF

- TVS devices are normally selected according to the working peak reverse voltage ( $V_{RWM}$ ), which should be equal or greater than the DC or continuous peak operating voltage level.
- $V_{BR}$  is measured at pulse test current  $I_T$ .

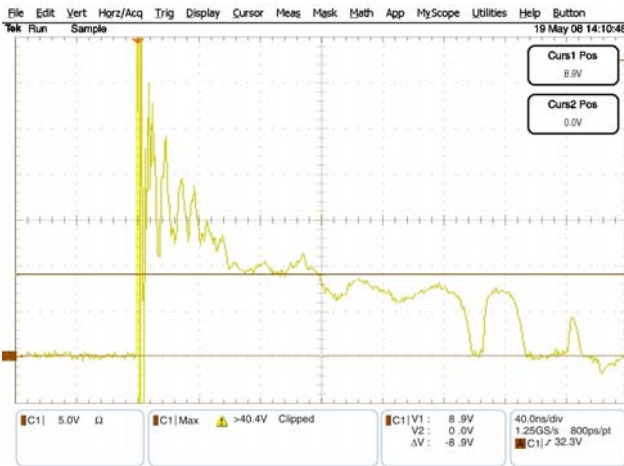

**Figure 1. ESD Clamping Voltage Screenshot**  
Positive 8 kV Contact per IEC61000-4-2

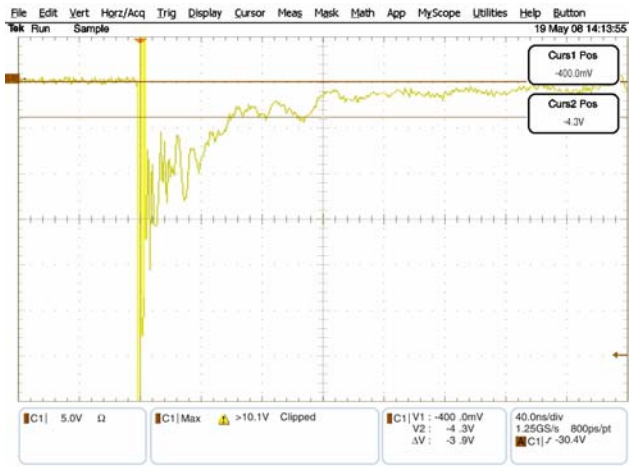

**Figure 2. ESD Clamping Voltage Screenshot**  
Negative 8 kV Contact per IEC61000-4-2



### UDFN6 1.6x1.6, 0.5P CASE 517AP ISSUE O

DATE 26 OCT 2007



SCALE 4:1

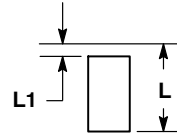
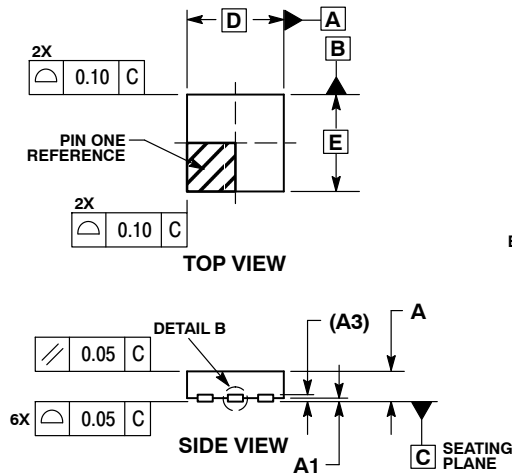

DETAIL A  
OPTIONAL  
CONSTRUCTION

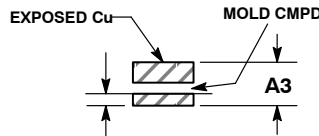

DETAIL B  
OPTIONAL  
CONSTRUCTION

NOTES:

1. DIMENSIONING AND TOLERANCING PER ASME Y14.5M, 1994.
2. CONTROLLING DIMENSION: MILLIMETERS.
3. DIMENSION b APPLIES TO PLATED TERMINAL AND IS MEASURED BETWEEN 0.15 AND 0.30 mm FROM TERMINAL.
4. COPLANARITY APPLIES TO THE EXPOSED PAD AS WELL AS THE TERMINALS.

MILLIMETERS		
DIM	MIN	MAX
A	0.45	0.55
A1	0.00	0.05
A3	0.13	REF
b	0.20	0.30
D	1.60	BSC
E	1.60	BSC
e	0.50	BSC
D2	1.10	1.30
E2	0.45	0.65
K	0.20	---
L	0.20	0.40
L1	0.00	0.15

### GENERIC MARKING DIAGRAM\*

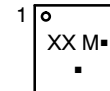

- XX = Specific Device Code
- M = Date Code
- = Pb-Free Package

(Note: Microdot may be in either location)  
\*This information is generic. Please refer to device data sheet for actual part marking.  
Pb-Free indicator, "G" or microdot "▪", may or may not be present.

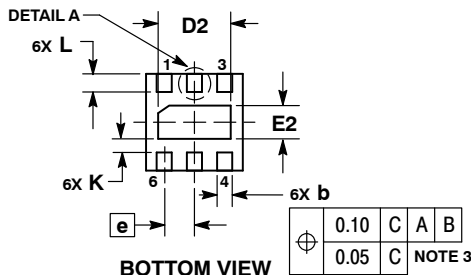

BOTTOM VIEW  
SOLDERMASK DEFINED MOUNTING FOOTPRINT\*

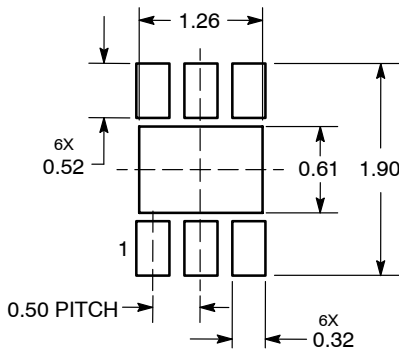

DIMENSIONS: MILLIMETERS

\*For additional information on our Pb-Free strategy and soldering details, please download the ON Semiconductor Soldering and Mounting Techniques Reference Manual, SOLDERRM/D.

DOCUMENT NUMBER:	98AON25711D	Electronic versions are uncontrolled except when accessed directly from the Document Repository. Printed versions are uncontrolled except when stamped "CONTROLLED COPY" in red.
DESCRIPTION:	6 PIN UDFN, 1.6X1.6, 0.5P	PAGE 1 OF 1

ON Semiconductor and ON are trademarks of Semiconductor Components Industries, LLC dba ON Semiconductor or its subsidiaries in the United States and/or other countries. ON Semiconductor reserves the right to make changes without further notice to any products herein. ON Semiconductor makes no warranty, representation or guarantee regarding the suitability of its products for any particular purpose, nor does ON Semiconductor assume any liability arising out of the application or use of any product or circuit, and specifically disclaims any and all liability, including without limitation special, consequential or incidental damages. ON Semiconductor does not convey any license under its patent rights nor the rights of others.

**onsemi**, **Onsemi**, and other names, marks, and brands are registered and/or common law trademarks of Semiconductor Components Industries, LLC dba "**onsemi**" or its affiliates and/or subsidiaries in the United States and/or other countries. **onsemi** owns the rights to a number of patents, trademarks, copyrights, trade secrets, and other intellectual property. A listing of **onsemi**'s product/patent coverage may be accessed at [www.onsemi.com/site/pdf/Patent-Marking.pdf](http://www.onsemi.com/site/pdf/Patent-Marking.pdf). **onsemi** reserves the right to make changes at any time to any products or information herein, without notice. The information herein is provided "as-is" and **onsemi** makes no warranty, representation or guarantee regarding the accuracy of the information, product features, availability, functionality, or suitability of its products for any particular purpose, nor does **onsemi** assume any liability arising out of the application or use of any product or circuit, and specifically disclaims any and all liability, including without limitation special, consequential or incidental damages. Buyer is responsible for its products and applications using **onsemi** products, including compliance with all laws, regulations and safety requirements or standards, regardless of any support or applications information provided by **onsemi**. "Typical" parameters which may be provided in **onsemi** data sheets and/or specifications can and do vary in different applications and actual performance may vary over time. All operating parameters, including "Typicals" must be validated for each customer application by customer's technical experts. **onsemi** does not convey any license under any of its intellectual property rights nor the rights of others. **onsemi** products are not designed, intended, or authorized for use as a critical component in life support systems or any FDA Class 3 medical devices or medical devices with a same or similar classification in a foreign jurisdiction or any devices intended for implantation in the human body. Should Buyer purchase or use **onsemi** products for any such unintended or unauthorized application, Buyer shall indemnify and hold **onsemi** and its officers, employees, subsidiaries, affiliates, and distributors harmless against all claims, costs, damages, and expenses, and reasonable attorney fees arising out of, directly or indirectly, any claim of personal injury or death associated with such unintended or unauthorized use, even if such claim alleges that **onsemi** was negligent regarding the design or manufacture of the part. **onsemi** is an Equal Opportunity/Affirmative Action Employer. This literature is subject to all applicable copyright laws and is not for resale in any manner.

## ADDITIONAL INFORMATION

### TECHNICAL PUBLICATIONS:

Technical Library: [www.onsemi.com/design/resources/technical-documentation](http://www.onsemi.com/design/resources/technical-documentation)  
onsemi Website: [www.onsemi.com](http://www.onsemi.com)

### ONLINE SUPPORT: [www.onsemi.com/support](http://www.onsemi.com/support)

For additional information, please contact your local Sales Representative at [www.onsemi.com/support/sales](http://www.onsemi.com/support/sales)

## Looking for pricing, stock, or lifecycle information?

Click below to explore more details on WIN SOURCE:

 [View NUP6012PMUTAG on WIN SOURCE](#)

 [ON Semiconductor](#) Information

## Optimize Your Supply Chain with WIN SOURCE Solutions

-  Global Sourcing Solution
-  Obsolete Management
-  Cost Control Management
-  Shortage Management
-  Alternative Solution
-  Excess Inventory Management