



**THE DATASHEET OF  
LD6835K/33PX**





# LD6835 series

Low-dropout regulator, high PSRR, 300 mA

Rev. 2 — 20 September 2013

Product data sheet

## 1. Product profile

### 1.1 General description

The LD6835 series is a small-size Low-DropOut (LDO) regulator family with a high-Power Supply Rejection Ratio (PSRR) of 75 dB and a voltage drop of 240 mV at 300 mA current rating. Operating voltages range from 1.75 V to 5.5 V. The products are available with fixed nominal output voltages  $V_{O(nom)}$  between 1.2 V and 3.6 V.

The LD6835 series products are available in a DFN1010C-4 (SOT1194-1) plastic package with a size of 1 mm × 1 mm × 0.55 mm. The devices are ideal for use in portable applications requiring component miniaturization.

### 1.2 Features and benefits

- High PSRR
- Low quiescent current
- Soft start with optimized start-up time
- Temperature watchdog
- Current limiter with foldback circuit
- Low standby current in shutdown mode (typical 0.1  $\mu$ A)
- Auto discharge or high-ohmic mode for the output state when disabled
- DFN1010C-4 (SOT1194-1) plastic package with a size of 1 mm × 1 mm × 0.55 mm
- Pb-free, Restriction of Hazardous Substances (RoHS) compliant, free of halogen and antimony (Dark Green compliant)

### 1.3 Applications

- Smartphones
- Mobile handsets
- Digital still cameras
- Tablet PCs
- Mobile internet devices
- Portable media players

### 1.4 Quick reference data

- $I_O = 300$  mA
- PSRR = 75 dB at 1 kHz
- RMS noise  $V_{n(o)(RMS)} = 60$   $\mu$ V at 10 Hz to 100 kHz
- $t_{startup(reg)} = 150$   $\mu$ s
- $V_I = 1.75$  V to 5.5 V
- $V_O = 1.2$  V to 3.6 V
- Dropout voltage  $V_{do} = 240$  mV at  $I_O = 300$  mA
- Quiescent current  $I_q = 35$   $\mu$ A at  $I_O = 0$  mA



## 2. Pinning information

### 2.1 Pinning

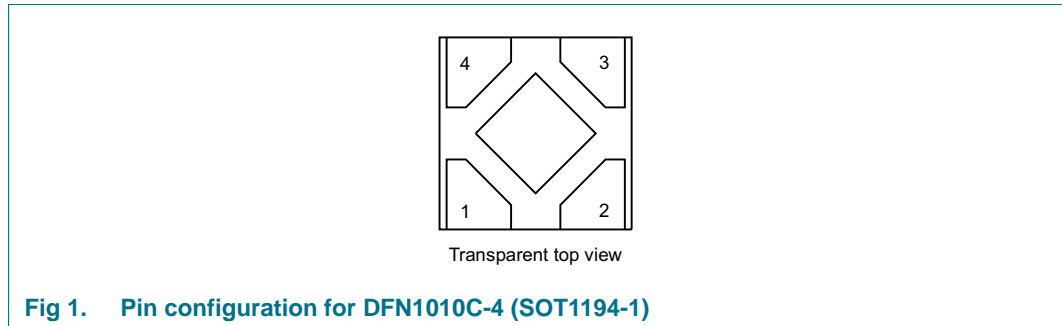

### 2.2 Pin description

**Table 1. Pin description for LD6835 series in DFN1010C-4 (SOT1194-1)**

Symbol	Pin	Description
OUT	1	regulator output voltage
GND	2	supply ground
EN	3	device enable input; active HIGH
IN	4	regulator input voltage
i.c.	TAB	internally connected <sup>[1]</sup>

[1] The TAB is GND level (It is placed on the reverse side of the IC). It is recommended to connect the TAB to GND for a good thermal performance. Leaving it unconnected is also allowed.

## 3. Ordering information

**Table 2. Ordering information**

Type number	Package		Version
	Name	Description	
LD6835K	DFN1010C-4 (HXSON4)	plastic thermal enhanced ultra thin small outline package; no leads; 4 terminals; body 1 × 1 × 0.55 mm	SOT1194-1

### 3.1 Ordering options

Further information on output voltage is available on request; see [Section 19 “Contact information”](#)

**Table 3. Type number extension of high-ohmic output**

Type number	Nominal output voltage $V_{O(nom)}$	Type number	Nominal output voltage $V_{O(nom)}$
LD6835K/12H	1.2 V	LD6835K/28H	2.8 V
LD6835K/15H	1.5 V	LD6835K/29H	2.9 V
LD6835K/18H	1.8 V	LD6835K/30H	3.0 V
LD6835K/22H	2.2 V	LD6835K/31H	3.1 V
LD6835K/25H	2.5 V	LD6835K/33H	3.3 V

**Table 4. Type number extension of pull-down output**

Type number	Nominal output voltage $V_{O(nom)}$	Type number	Nominal output voltage $V_{O(nom)}$
LD6835K/12P	1.2 V	LD6835K/285P	2.85 V
LD6835K/15P	1.5 V	LD6835K/29P	2.9 V
LD6835K/18P	1.8 V	LD6835K/30P	3.0 V
LD6835K/22P	2.2 V	LD6835K/31P	3.1 V
LD6835K/25P	2.5 V	LD6835K/33P	3.3 V
LD6835K/28P	2.8 V	-	-

## 4. Block diagram

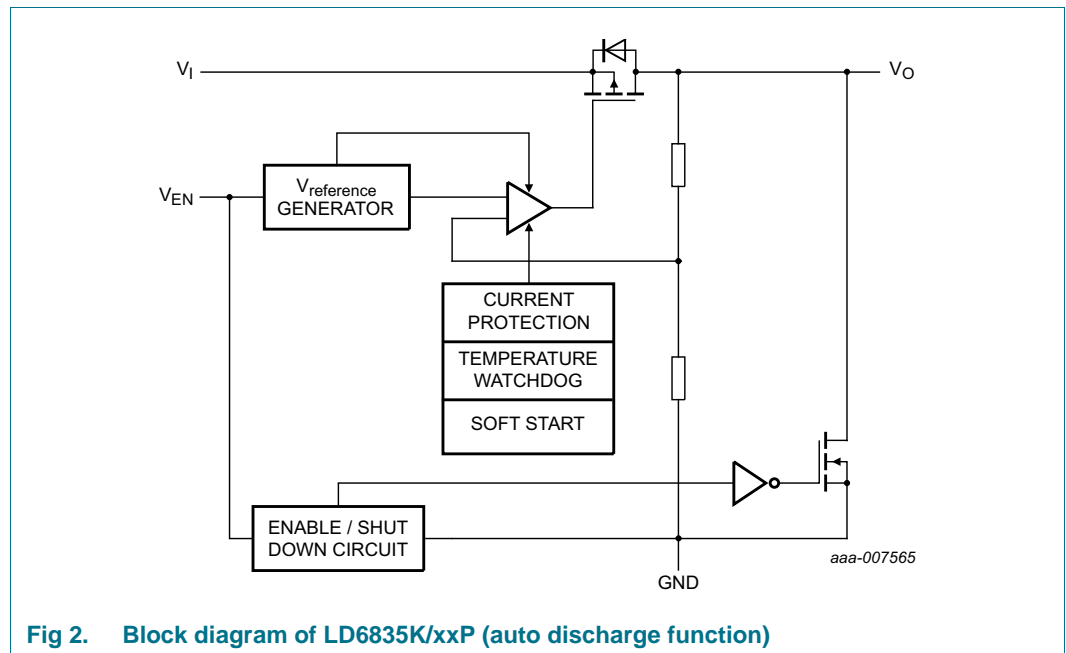

**Fig 2. Block diagram of LD6835K/xxP (auto discharge function)**

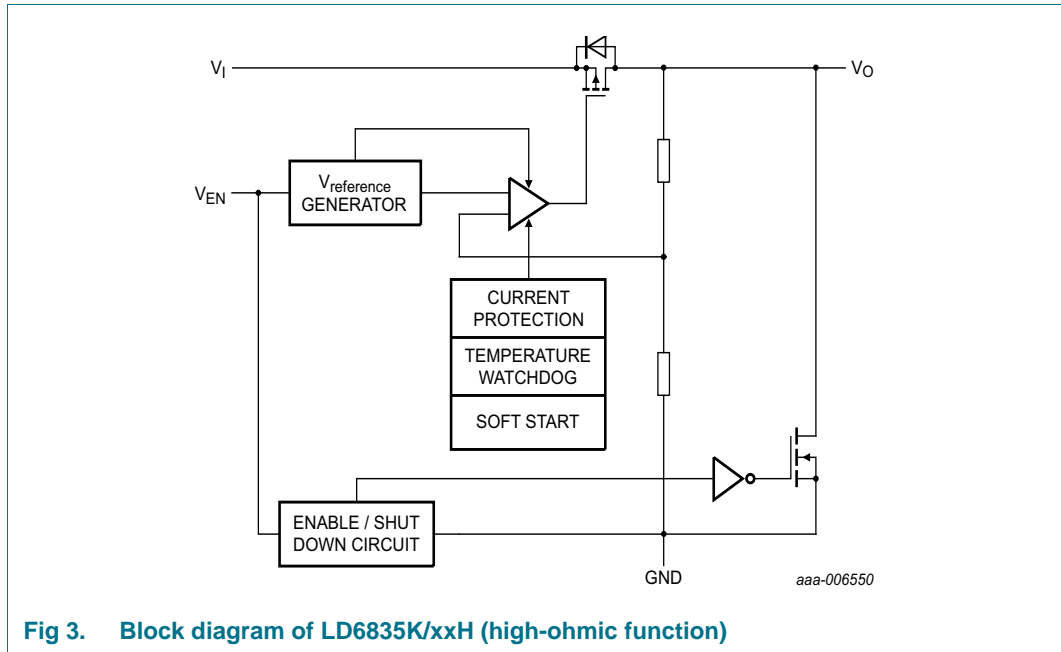

Fig 3. Block diagram of LD6835K/xxH (high-ohmic function)

## 5. Limiting values

Table 5. Limiting values

In accordance with the Absolute Maximum Rating System (IEC 60134). Voltages are referenced to GND (ground = 0 V).

Symbol	Parameter	Conditions	Min	Max	Unit
$V_I$	input voltage	4 ms transient	-0.5	+6.0	V
$V_O$	output voltage	4 ms transient	-0.5	+6.0	V
$V_{EN}$	voltage on pin EN	4 ms transient	-0.5	+6.0	V
$P_{tot}$	total power dissipation		[1] -	400	mW
$T_{stg}$	storage temperature		-55	+150	°C
$T_j$	junction temperature		-40	+125	°C
$T_{amb}$	ambient temperature		-40	+85	°C
$V_{ESD}$	electrostatic discharge voltage	human body mode	[2] -	±2	kV
		machine model	[3] -	±200	V

[1] The (absolute) maximum power dissipation depends on the junction temperature  $T_j$ . Higher power dissipation is allowed with lower ambient temperatures. The conditions to determine the specified values are  $T_{amb} = 25\text{ °C}$  and the use of a two-layer Printed-Circuit Board (PCB).

[2] According to JESD22-A114F.

[3] According to JESD22-A115C.

## 6. Recommended operating conditions

**Table 6. Operating conditions**

Voltages are referenced to GND (ground = 0 V).

Symbol	Parameter	Conditions	Min	Max	Unit
$T_{amb}$	ambient temperature		-40	+85	°C
$T_j$	junction temperature		-	125	°C
<b>Pin IN</b>					
$V_I$	input voltage		1.75	5.5	V
$C_{ext(IN)}$	external capacitance on pin IN		1	-	μF
<b>Pin EN</b>					
$V_{EN}$	voltage on pin EN		-0.5	+5.5	V
<b>Pin OUT</b>					
$V_O$	output voltage		-0.5	$V_I + 0.3$	V
$C_{L(ext)}$	external load capacitance		[1] 1	-	μF

[1] See [Section 10.1 "Capacitor values"](#).

## 7. Thermal characteristics

**Table 7. Thermal characteristics**

Symbol	Parameter	Conditions	Typ	Unit
$R_{th(j-a)}$	thermal resistance from junction to ambient		[1][2] 250	K/W

- [1] The overall  $R_{th(j-a)}$  can vary depending on the board layout. To minimize the effective  $R_{th(j-a)}$ , all pins must have a solid connection to large Cu layer areas for example to the power and ground layer. In multilayer PCB applications, the second layer should be used to create a large heat spreader area directly below the LDO. If this layer is either ground or power, it should be connected with several vias to the top layer connecting to the device ground or supply. Avoid the use of solder-stop varnish under the chip.
- [2] Use the measurement data given for a rough estimation of the  $R_{th(j-a)}$  in your application. The actual  $R_{th(j-a)}$  value can vary in applications using different layer stacks and layouts.

## 8. Characteristics

**Table 8. Electrical characteristics**

At recommended input voltages and  $T_{amb} = -40\text{ °C}$  to  $+85\text{ °C}$ ; voltages are referenced to GND (ground = 0 V);  $V_I = V_{O(nom)} + 1.0\text{ V}$ ; output capacitor  $C_{L(ext)} = 1\text{ }\mu\text{F}$ ; input capacitor  $C_{ext(IN)} = 1\text{ }\mu\text{F}$ ; unless otherwise specified.

Symbol	Parameter	Conditions	Min	Typ	Max	Unit
<b>Output voltage</b>						
$V_{do}$	dropout voltage	$I_O = 300\text{ mA}$ ; $V_I = V_{O(nom)} - 0.1\text{ V}$	[1] -	240	-	mV
$\Delta V_O$	output voltage variation	$V_O \geq 1.8\text{ V}$ ; $I_O = 1\text{ mA}$				
		$T_{amb} = +25\text{ °C}$	-2	$\pm 0.5$	+2	%
		$-40\text{ °C} \leq T_{amb} \leq +85\text{ °C}$	[1] -3	-	+3	%
		$V_O < 1.8\text{ V}$ ; $I_O = 1\text{ mA}$				
		$T_{amb} = +25\text{ °C}$	-3	$\pm 0.5$	+3	%
		$-40\text{ °C} \leq T_{amb} \leq +85\text{ °C}$	[1] -4	-	+4	%
<b>Line regulation error</b>						
$\Delta V_O / (V_O \times \Delta V_I)$	relative output voltage variation with input voltage	$V_I = (V_{O(nom)} + 0.5\text{ V})$ to $5.0\text{ V}$ ; $I_O = 1\text{ mA}$	[1] -0.1	-	+0.1	%/V
<b>Load regulation error</b>						
$\Delta V_O / (V_O \times \Delta I_O)$	relative output voltage variation with output current	$1\text{ mA} \leq I_O \leq 300\text{ mA}$	[1] -0.01	$\pm 0.0025$	+0.01	%/mA
<b>Output current</b>						
$I_O$	output current		300	-	-	mA
$I_{act(fold)}$	foldback activation current	$V_O = 0.9 \times V_{O(nom)}$	[1] -	500	-	mA
$I_{sc}$	short-circuit current	$V_O = 0\text{ V}$	[1] -	60	-	mA
<b>Regulator quiescent current</b>						
$I_q$	quiescent current	$V_{EN} = 1.1\text{ V}$ ; $I_O = 0\text{ mA}$	-	35	75	$\mu\text{A}$
		$V_{EN} = 1.1\text{ V}$ ; $I_O = 300\text{ mA}$	[1] -	450	-	$\mu\text{A}$
		$V_{EN} \leq 0.4\text{ V}$	-	0.1	1	$\mu\text{A}$
<b>Ripple rejection and output noise</b>						
PSRR	power supply rejection ratio	$f_{ripple} = 1\text{ kHz}$ ; $I_O = 30\text{ mA}$	[1] -	75	-	dB
$V_{n(o)(RMS)}$	RMS output noise voltage	$f_{ripple} = 10\text{ Hz}$ to $100\text{ kHz}$ ; $I_O = 10\text{ mA}$	[1] -	60	-	$\mu\text{V}$
<b>Enable input and timing</b>						
$V_{IL}$	LOW-level input voltage	pin EN	0	-	0.4	V
$V_{IH}$	HIGH-level input voltage	pin EN	1.1	-	5.5	V
$I_{en}$	enable current	pin EN	-	400	-	nA
$t_{startup(reg)}$	regulator start-up time	$V_O = 0.95 \times V_{O(nom)}$ ; $I_O = 300\text{ mA}$	[2] -	150	-	$\mu\text{s}$
<b>LD6835K/xxP auto discharge function</b>						
$t_{sd(reg)}$	regulator shutdown time	$V_O = 0.05 \times V_{O(nom)}$	-	300	-	$\mu\text{s}$
$R_{pd}$	pull-down resistance		-	100	-	$\Omega$
<b>Thermal protection</b>						
$T_{sd}$	shutdown temperature		[3] -	160	-	$^{\circ}\text{C}$
$T_{sd(hys)}$	shutdown temperature hysteresis		[3] -	20	-	K

[1] Parameter is checked, verified and guaranteed by design.

- [2]  $V_{O(nom)}$  = nominal output voltage (devices specific).
- [3] If the device reaches the shutdown temperature, the LDO is disabled. The LDO will restart after the device temperature is decreased to the shutdown temperature minus the shutdown temperature hysteresis.

## 9. Dynamic behavior

All results described in this section are based on measurements of types LD6835K/xxx from the LD6835 product series.

### 9.1 Dropout

The dropout voltage is defined as the smallest input-to-output voltage difference at a specified load current when the regulator operates within its linear region with the pass transistor functioning simply as a resistor. This means that the input voltage is below the nominal output voltage value.

A small dropout voltage guarantees lower power consumption and maximizes efficiency.

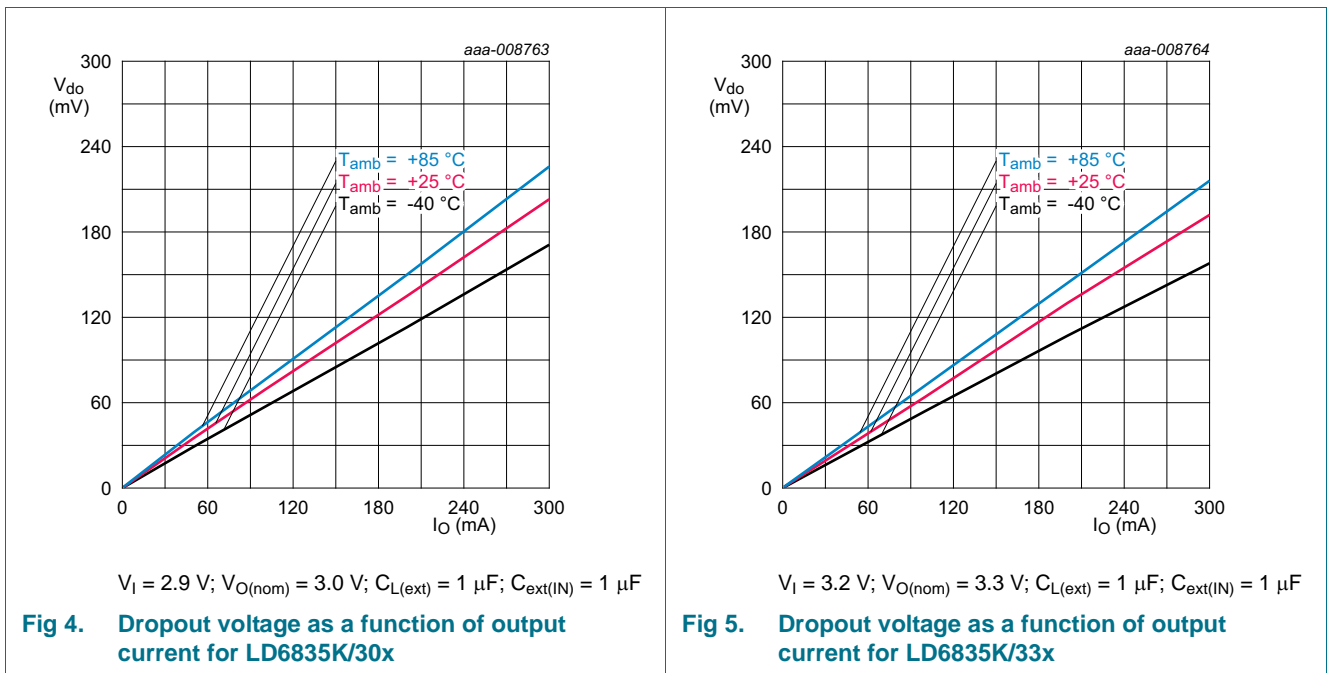

9.2 Temperature dependency

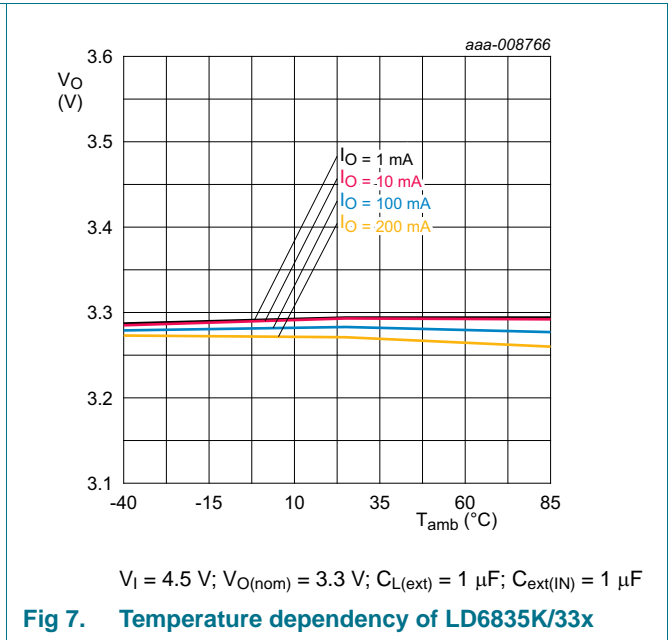
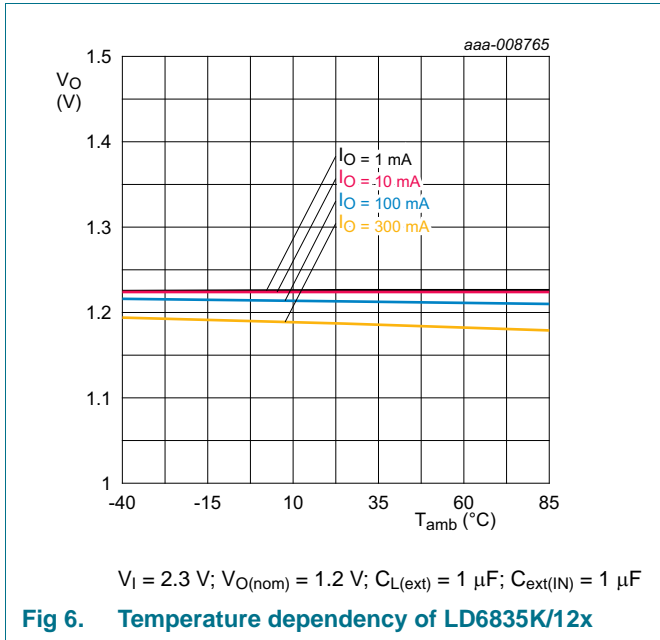

9.3 Noise

Output noise voltage of an LDO circuit is given as noise density or RMS output noise voltage over a defined range of frequencies (10 Hz to 100 kHz). Permanent conditions are a constant output current and a ripple-free input voltage. The output noise voltage is generated by the LDO regulator.

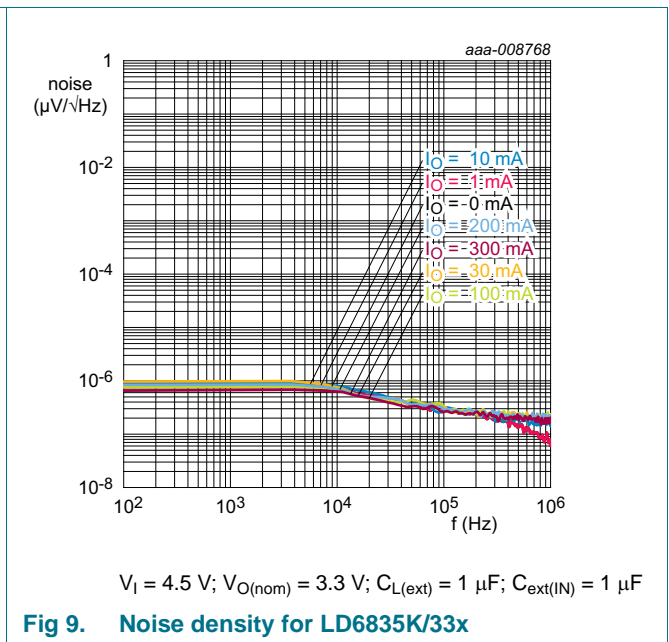
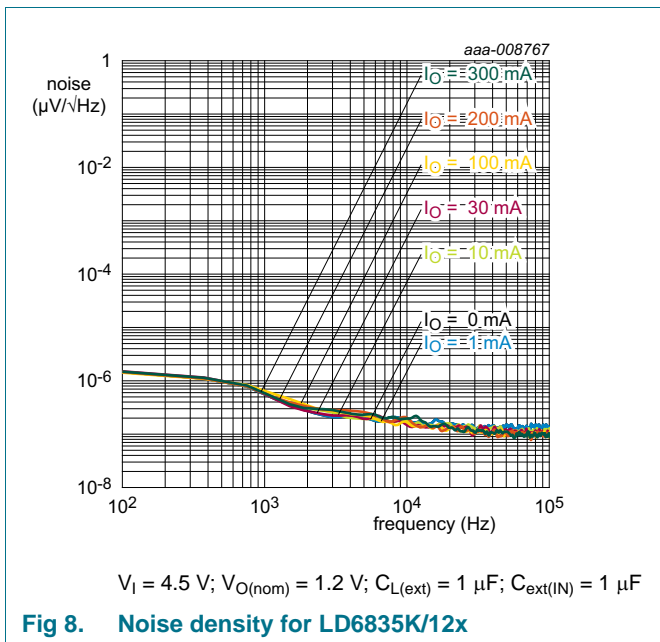

### 9.4 Quiescent current

Quiescent or ground current is the difference between the input and the output current of the regulator.

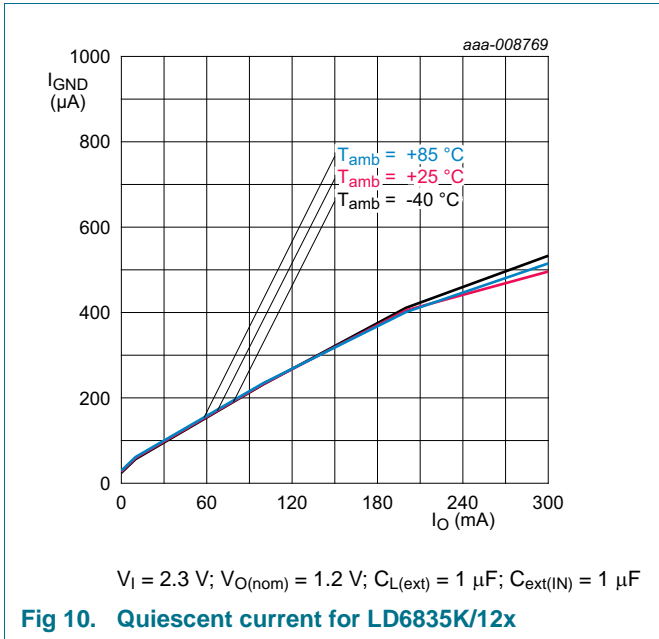

Fig 10. Quiescent current for LD6835K/12x

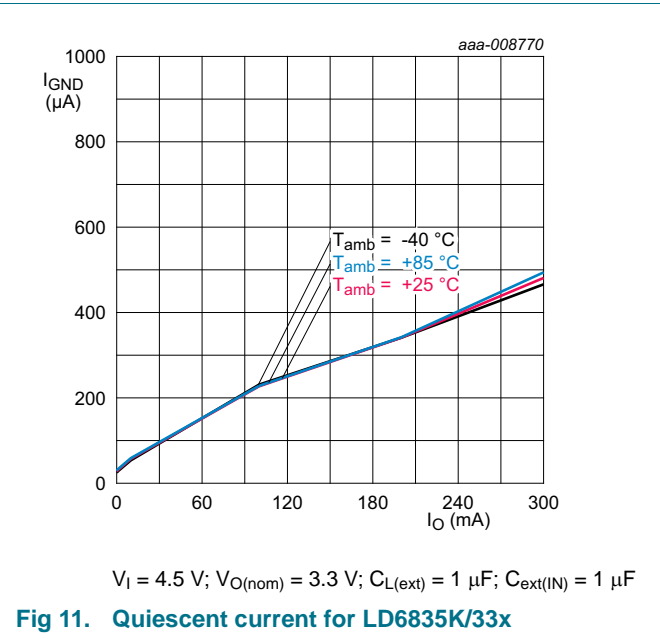
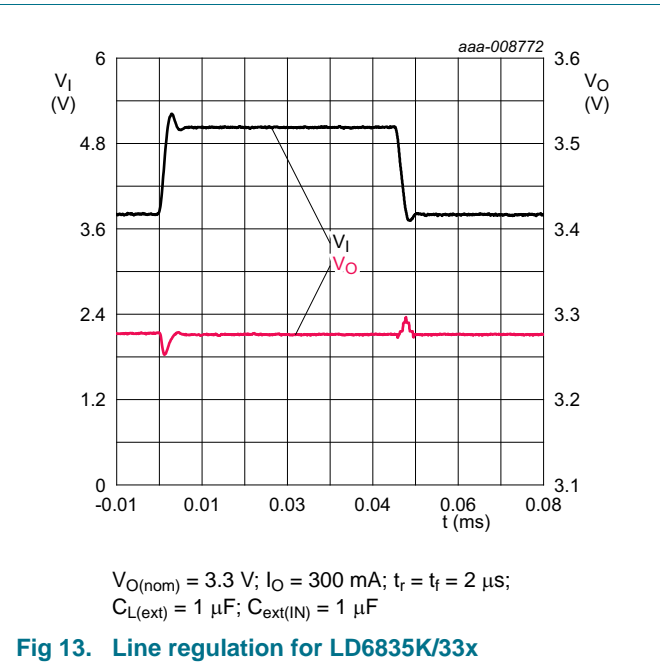
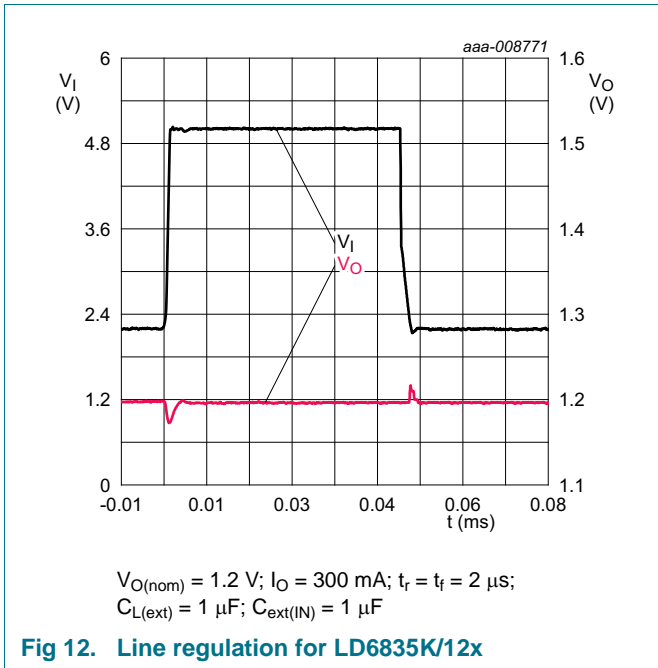

Fig 11. Quiescent current for LD6835K/33x

### 9.5 Line regulation

Line regulation response is the capability of the circuit to maintain the nominal output voltage while varying the input voltage.

$$\text{Line regulation (\%/V)} = \frac{\Delta V_O}{\Delta V_I} \times \frac{100}{V_O} \tag{1}$$



### 9.6 Load regulation

Load regulation is the capability of the circuit to maintain the nominal output voltage while varying the output load current.

$$\text{Load regulation (\%/mA)} = \frac{\frac{\Delta V_O}{V_{O(nom)}} \times 100}{\Delta I_O} \tag{2}$$

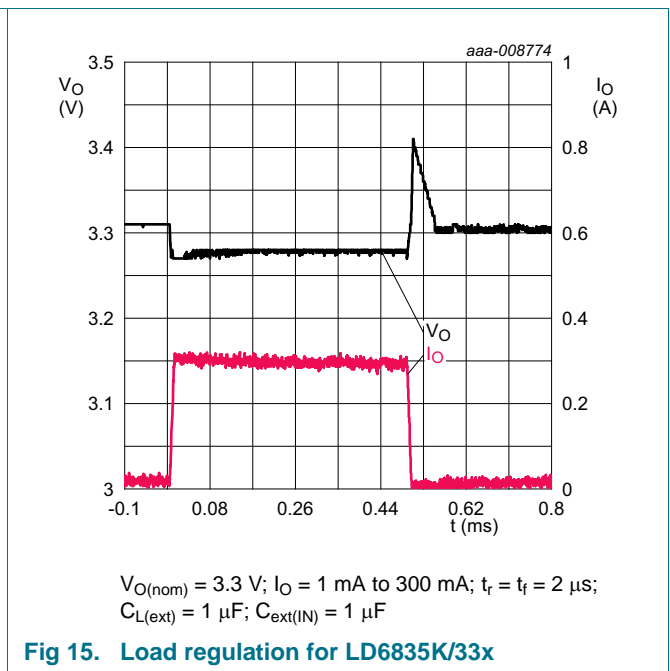
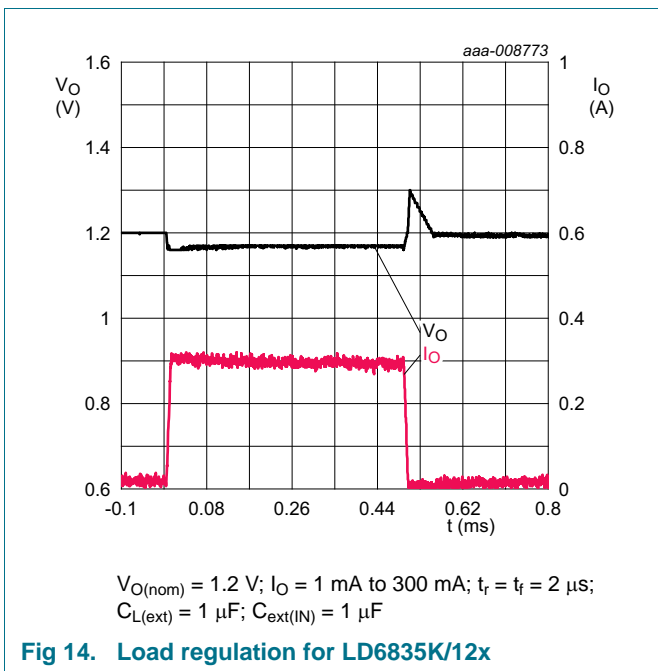

9.7 Start-up, inrush current

Start-up time defines the time needed for the LDO to achieve 95 % of its typical output voltage level after activation via the enable pin.

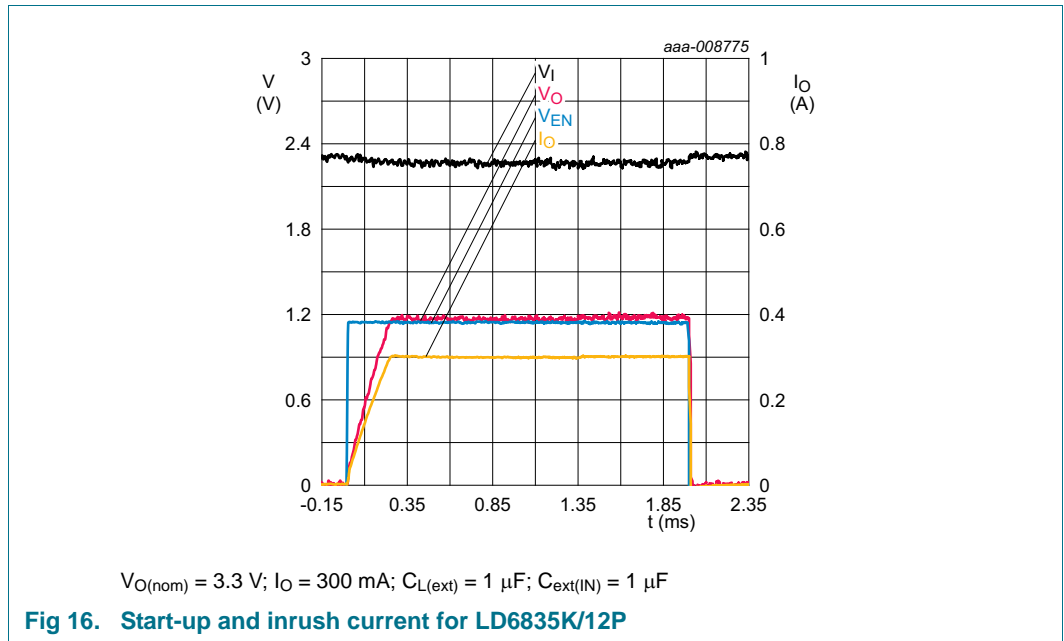

9.8 Power Supply Rejection Ratio (PSRR)

PSRR stands for the capability of the regulator to suppress unwanted signals on the input voltage like noise or ripples.

$$PSRR\ (dB) = (-20)\log\frac{V_{O(ripple)}}{V_{I(ripple)}}\ \text{for all frequencies.}$$

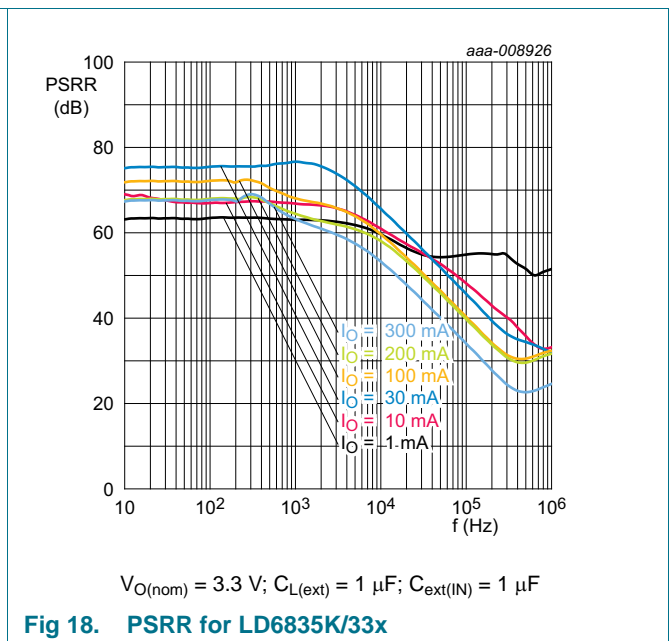
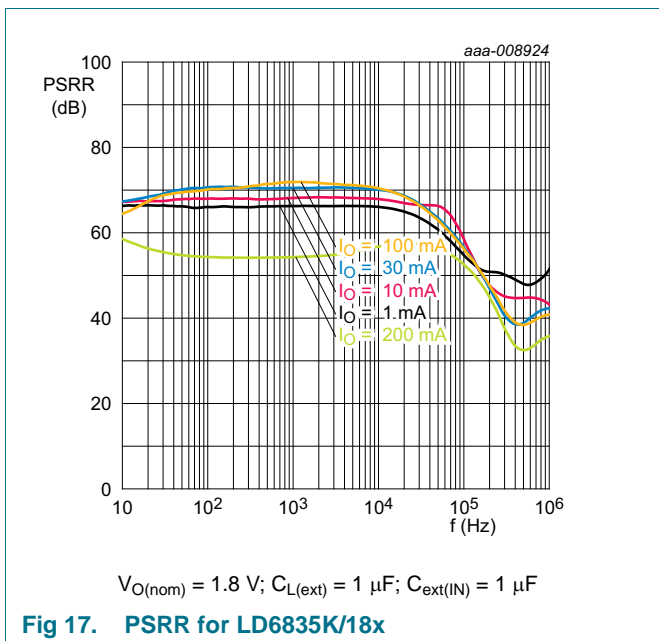

## 10. Application information

### 10.1 Capacitor values

The LD6835 series requires external capacitors at the output to guarantee a stable regulator behavior. Also an input capacitor is recommended to keep the input voltage stable. These capacitors should not violate the specified minimum Equivalent Series Resistance (ESR).

The absolute value of the total capacitance attached to the output pin OUT influences the regulator shutdown time ( $t_{sd(reg)}$ ) of the LD6835 series.

**Table 9. External load capacitor**

Symbol	Parameter	Conditions	Min	Typ	Max	Unit
$C_{ext(IN)}$	external capacitance on pin IN		[1] 0.7	1.0	-	$\mu F$
$C_{L(ext)}$	external load capacitance		[1] 0.7	1.0	-	$\mu F$
ESR	equivalent series resistance		5	-	500	m $\Omega$

[1] The minimum value of capacitance for stability and correct operation is 0.7  $\mu F$ . The capacitor tolerance should be  $\pm 30\%$  (over the temperature range). The full range of operating conditions for the capacitor in the application should be considered during device selection to ensure that this minimum capacitance specification is met. The recommended capacitor type is X7R to meet the full temperature specification of  $-40\text{ }^{\circ}C$  to  $+125\text{ }^{\circ}C$ .

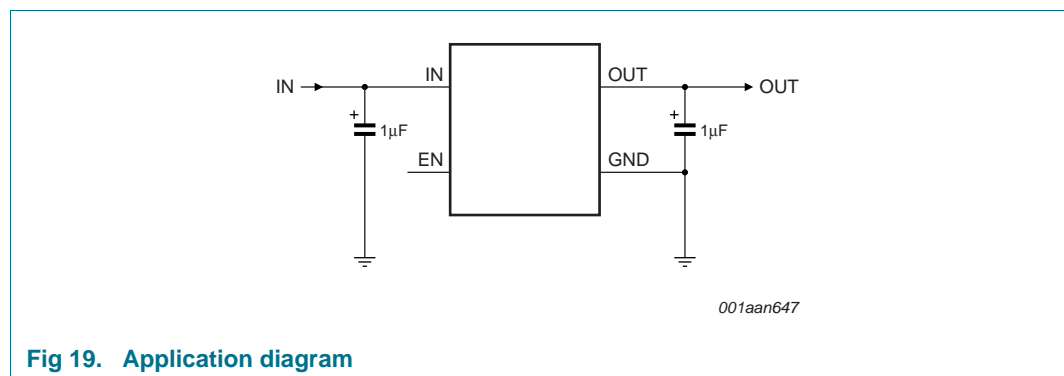

**Fig 19. Application diagram**

## 11. Test information

### 11.1 Quality information

This product has been qualified in accordance with *NX1-00023 NXP Semiconductors Quality and Reliability Specification* and is suitable for use in consumer applications.

12. Marking

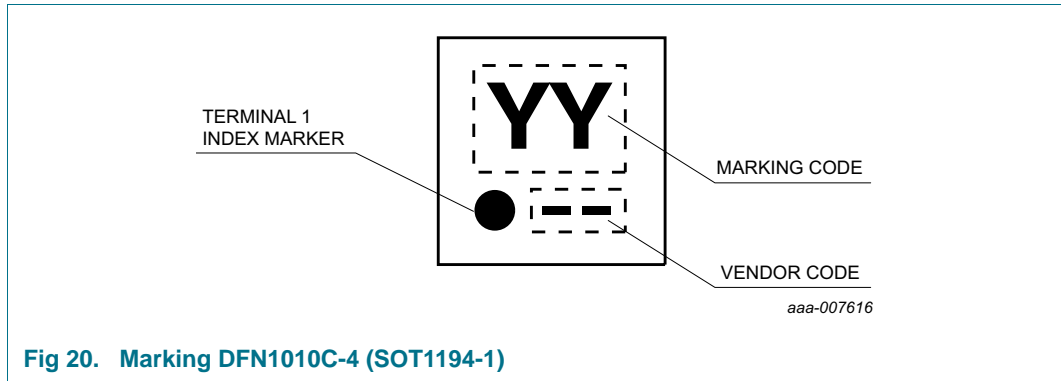

Table 10. Marking of high-ohmic output

Type number	Nominal output voltage $V_{O(nom)}$	Marking code	Type number	Nominal output voltage $V_{O(nom)}$	Marking code
LD6835K/12H	1.2 V	AA	LD6835K/28H	2.8 V	QA
LD6835K/15H	1.5 V	DA	LD6835K/29H	2.9 V	RA
LD6835K/18H	1.8 V	GA	LD6835K/30H	3.0 V	SA
LD6835K/22H	2.2 V	KA	LD6835K/31H	3.1 V	TA
LD6835K/25H	2.5 V	NA	LD6835K/33H	3.3 V	VA

Table 11. Marking of pull-down output

Type number	Nominal output voltage $V_{O(nom)}$	Marking code	Type number	Nominal output voltage $V_{O(nom)}$	Marking code
LD6835K/12P	1.2 V	AB	LD6835K/285P	2.85 V	ZB
LD6835K/15P	1.5 V	DB	LD6835K/29P	2.9 V	RB
LD6835K/18P	1.8 V	GB	LD6835K/30P	3.0 V	SB
LD6835K/22P	2.2 V	KB	LD6835K/31P	3.1 V	TB
LD6835K/25P	2.5 V	NB	LD6835K/33P	3.3 V	VB
LD6835K/28P	2.8 V	QB	-	-	-

### 13. Package outline

Plastic thermal enhanced ultra thin small outline package; no leads;  
4 terminals; body 1 x 1 x 0.55 mm

SOT1194-1

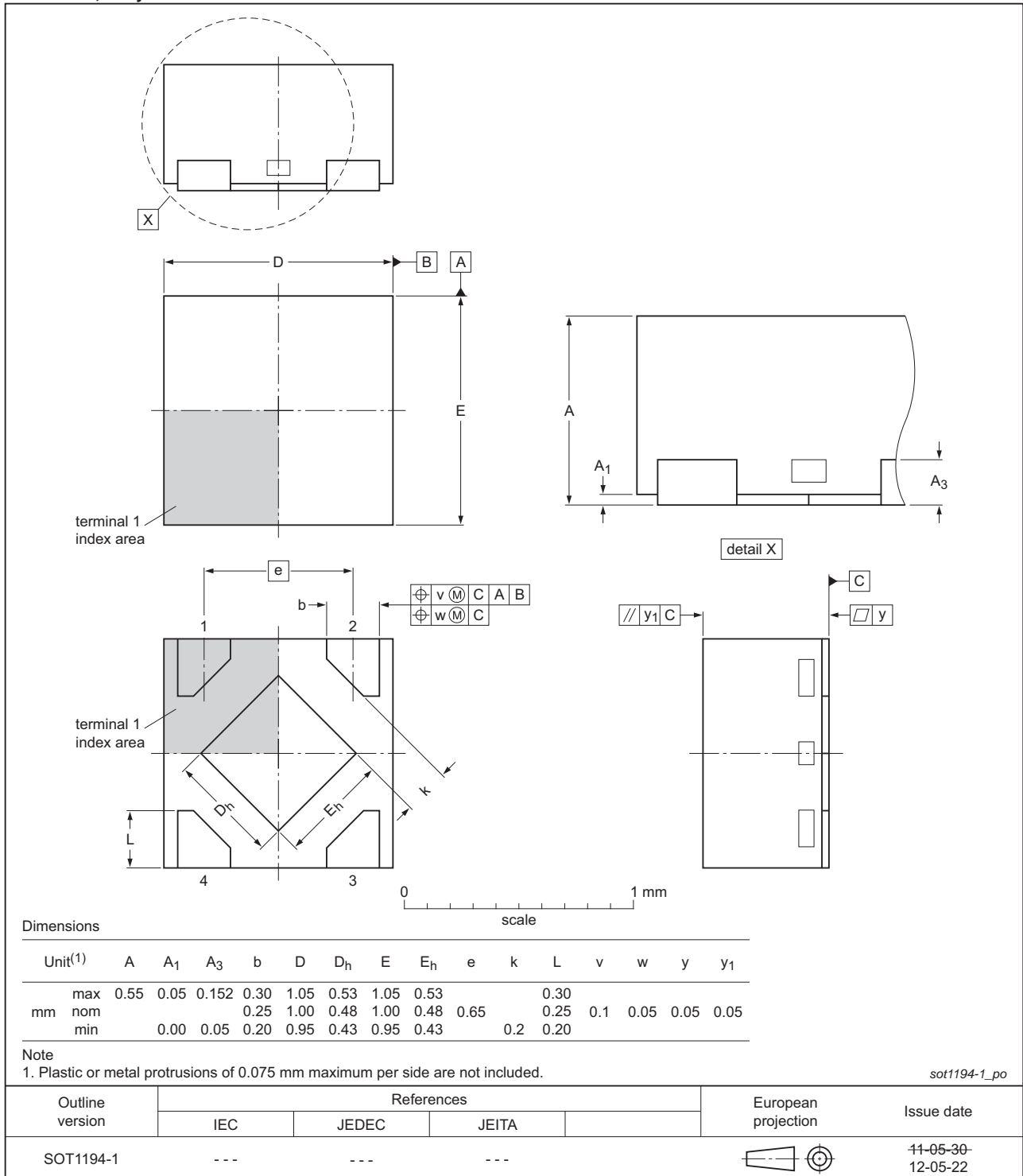

Fig 21. Package outline DFN1010C-4 (SOT1194-1)

## 14. Packing information

### 14.1 Packing methods

Table 12. Packing methods

Type number	Package	Description	Orientation <a href="#">[1]</a>	12NC ending	Packing quantity
LD6835K	DFN1010C-4 (SOT1194-1)	2 mm pitch, 8 mm tape and reel	Q1	115	10000

[1] For further information about orientation, see [Section 14.2](#).

### 14.2 Carrier tape information

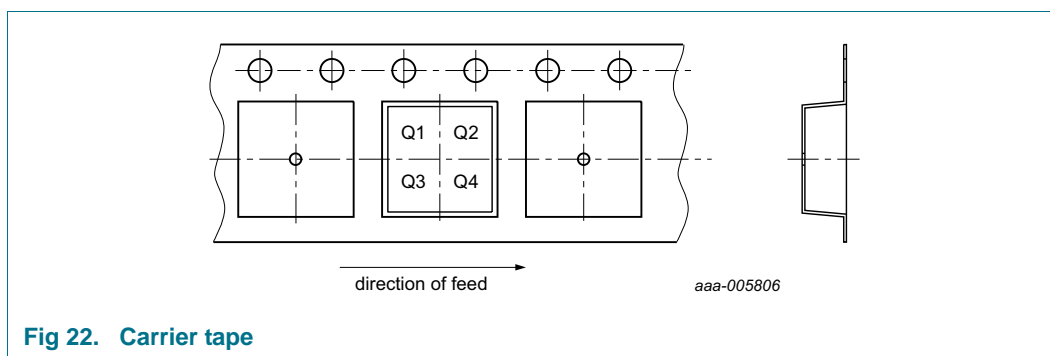

Fig 22. Carrier tape

Table 13. Orientations

Orientation	Meaning	Pin 1 location
Q1	quadrant 1	upper left
Q2	quadrant 2	upper right
Q3	quadrant 3	lower left
Q4	quadrant 4	lower right

15. Soldering

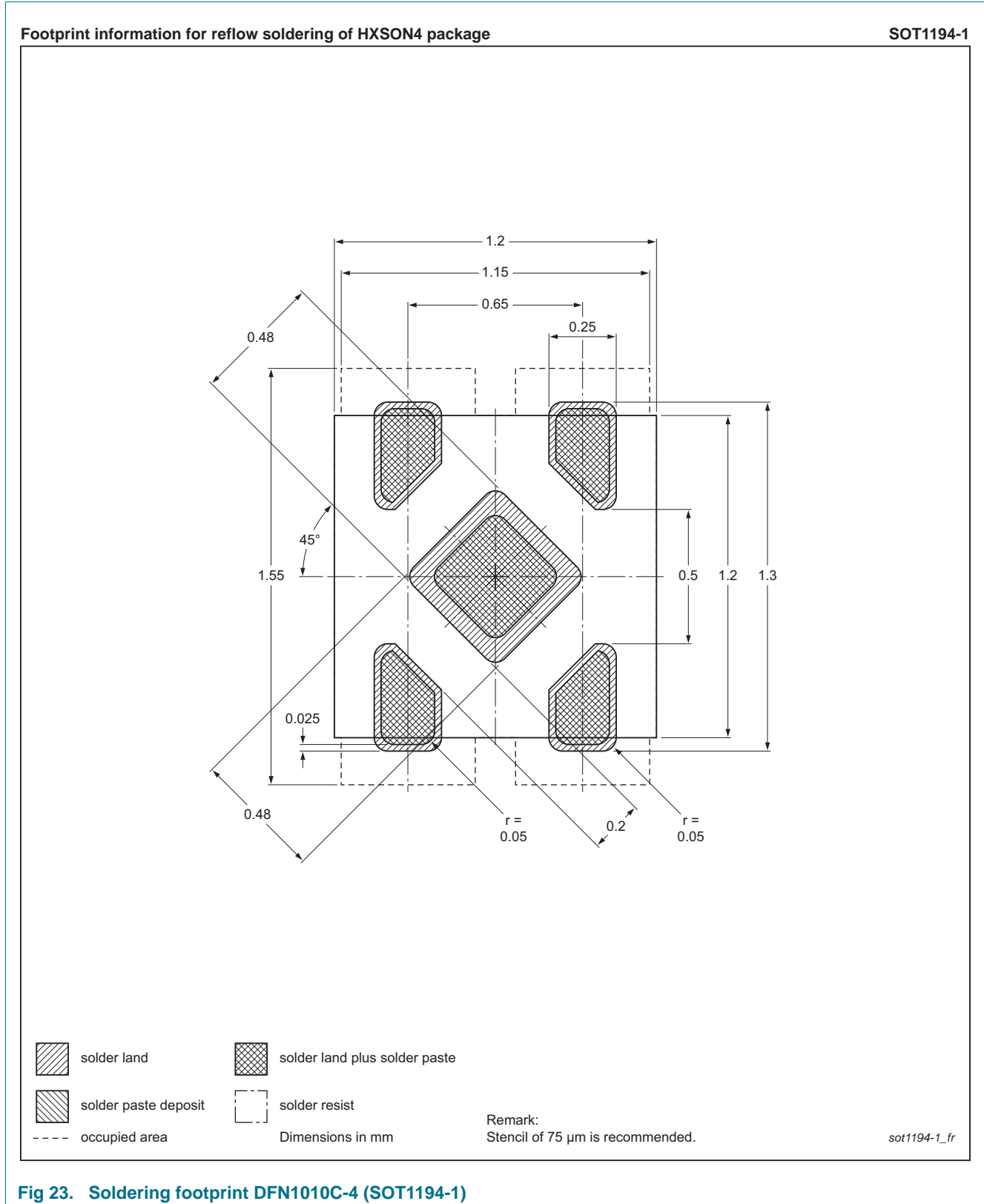

Fig 23. Soldering footprint DFN1010C-4 (SOT1194-1)

## 16. Soldering of SMD packages

This text provides a very brief insight into a complex technology. A more in-depth account of soldering ICs can be found in Application Note *AN10365 "Surface mount reflow soldering description"*.

### 16.1 Introduction to soldering

Soldering is one of the most common methods through which packages are attached to Printed Circuit Boards (PCBs), to form electrical circuits. The soldered joint provides both the mechanical and the electrical connection. There is no single soldering method that is ideal for all IC packages. Wave soldering is often preferred when through-hole and Surface Mount Devices (SMDs) are mixed on one printed wiring board; however, it is not suitable for fine pitch SMDs. Reflow soldering is ideal for the small pitches and high densities that come with increased miniaturization.

### 16.2 Wave and reflow soldering

Wave soldering is a joining technology in which the joints are made by solder coming from a standing wave of liquid solder. The wave soldering process is suitable for the following:

- Through-hole components
- Leaded or leadless SMDs, which are glued to the surface of the printed circuit board

Not all SMDs can be wave soldered. Packages with solder balls, and some leadless packages which have solder lands underneath the body, cannot be wave soldered. Also, leaded SMDs with leads having a pitch smaller than ~0.6 mm cannot be wave soldered, due to an increased probability of bridging.

The reflow soldering process involves applying solder paste to a board, followed by component placement and exposure to a temperature profile. Leaded packages, packages with solder balls, and leadless packages are all reflow solderable.

Key characteristics in both wave and reflow soldering are:

- Board specifications, including the board finish, solder masks and vias
- Package footprints, including solder thieves and orientation
- The moisture sensitivity level of the packages
- Package placement
- Inspection and repair
- Lead-free soldering versus SnPb soldering

### 16.3 Wave soldering

Key characteristics in wave soldering are:

- Process issues, such as application of adhesive and flux, clinching of leads, board transport, the solder wave parameters, and the time during which components are exposed to the wave
- Solder bath specifications, including temperature and impurities

### 16.4 Reflow soldering

Key characteristics in reflow soldering are:

- Lead-free versus SnPb soldering; note that a lead-free reflow process usually leads to higher minimum peak temperatures (see [Figure 24](#)) than a SnPb process, thus reducing the process window
- Solder paste printing issues including smearing, release, and adjusting the process window for a mix of large and small components on one board
- Reflow temperature profile; this profile includes preheat, reflow (in which the board is heated to the peak temperature) and cooling down. It is imperative that the peak temperature is high enough for the solder to make reliable solder joints (a solder paste characteristic). In addition, the peak temperature must be low enough that the packages and/or boards are not damaged. The peak temperature of the package depends on package thickness and volume and is classified in accordance with [Table 14](#) and [15](#)

**Table 14. SnPb eutectic process (from J-STD-020D)**

Package thickness (mm)	Package reflow temperature (°C)	
	Volume (mm <sup>3</sup> )	
	< 350	≥ 350
< 2.5	235	220
≥ 2.5	220	220

**Table 15. Lead-free process (from J-STD-020D)**

Package thickness (mm)	Package reflow temperature (°C)		
	Volume (mm <sup>3</sup> )		
	< 350	350 to 2000	> 2000
< 1.6	260	260	260
1.6 to 2.5	260	250	245
> 2.5	250	245	245

Moisture sensitivity precautions, as indicated on the packing, must be respected at all times.

Studies have shown that small packages reach higher temperatures during reflow soldering, see [Figure 24](#).

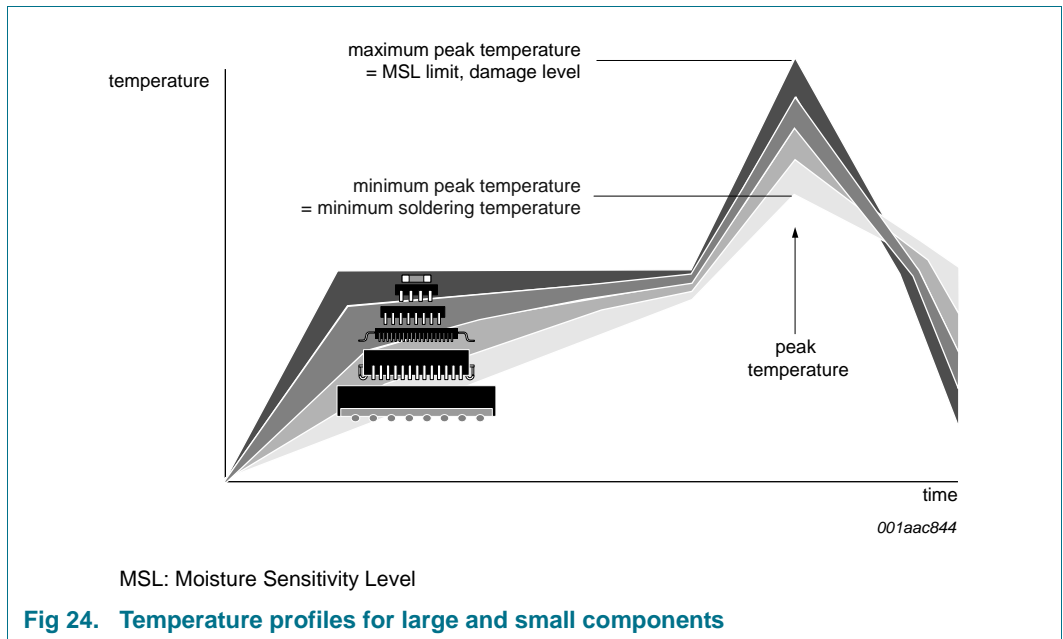

For further information on temperature profiles, refer to Application Note AN10365 “Surface mount reflow soldering description”.

## 17. Revision history

Table 16. Revision history

Document ID	Release date	Data sheet status	Change notice	Supersedes
LD6835_SER v.2	20130920	Product data sheet	-	LD6835_SER v.1
Modifications:	<ul style="list-style-type: none"> <li>Data sheet status changed</li> </ul>			
LD6835_SER v.1	20130704	Preliminary data sheet	-	-

## 18. Legal information

### 18.1 Data sheet status

Document status <sup>[1][2]</sup>	Product status <sup>[3]</sup>	Definition
Objective [short] data sheet	Development	This document contains data from the objective specification for product development.
Preliminary [short] data sheet	Qualification	This document contains data from the preliminary specification.
Product [short] data sheet	Production	This document contains the product specification.

[1] Please consult the most recently issued document before initiating or completing a design.

[2] The term 'short data sheet' is explained in section "Definitions".

[3] The product status of device(s) described in this document may have changed since this document was published and may differ in case of multiple devices. The latest product status information is available on the Internet at URL <http://www.nxp.com>.

### 18.2 Definitions

**Draft** — The document is a draft version only. The content is still under internal review and subject to formal approval, which may result in modifications or additions. NXP Semiconductors does not give any representations or warranties as to the accuracy or completeness of information included herein and shall have no liability for the consequences of use of such information.

**Short data sheet** — A short data sheet is an extract from a full data sheet with the same product type number(s) and title. A short data sheet is intended for quick reference only and should not be relied upon to contain detailed and full information. For detailed and full information see the relevant full data sheet, which is available on request via the local NXP Semiconductors sales office. In case of any inconsistency or conflict with the short data sheet, the full data sheet shall prevail.

**Product specification** — The information and data provided in a Product data sheet shall define the specification of the product as agreed between NXP Semiconductors and its customer, unless NXP Semiconductors and customer have explicitly agreed otherwise in writing. In no event however, shall an agreement be valid in which the NXP Semiconductors product is deemed to offer functions and qualities beyond those described in the Product data sheet.

### 18.3 Disclaimers

**Limited warranty and liability** — Information in this document is believed to be accurate and reliable. However, NXP Semiconductors does not give any representations or warranties, expressed or implied, as to the accuracy or completeness of such information and shall have no liability for the consequences of use of such information. NXP Semiconductors takes no responsibility for the content in this document if provided by an information source outside of NXP Semiconductors.

In no event shall NXP Semiconductors be liable for any indirect, incidental, punitive, special or consequential damages (including - without limitation - lost profits, lost savings, business interruption, costs related to the removal or replacement of any products or rework charges) whether or not such damages are based on tort (including negligence), warranty, breach of contract or any other legal theory.

Notwithstanding any damages that customer might incur for any reason whatsoever, NXP Semiconductors' aggregate and cumulative liability towards customer for the products described herein shall be limited in accordance with the *Terms and conditions of commercial sale* of NXP Semiconductors.

**Right to make changes** — NXP Semiconductors reserves the right to make changes to information published in this document, including without limitation specifications and product descriptions, at any time and without notice. This document supersedes and replaces all information supplied prior to the publication hereof.

**Suitability for use** — NXP Semiconductors products are not designed, authorized or warranted to be suitable for use in life support, life-critical or safety-critical systems or equipment, nor in applications where failure or malfunction of an NXP Semiconductors product can reasonably be expected to result in personal injury, death or severe property or environmental damage. NXP Semiconductors and its suppliers accept no liability for inclusion and/or use of NXP Semiconductors products in such equipment or applications and therefore such inclusion and/or use is at the customer's own risk.

**Applications** — Applications that are described herein for any of these products are for illustrative purposes only. NXP Semiconductors makes no representation or warranty that such applications will be suitable for the specified use without further testing or modification.

Customers are responsible for the design and operation of their applications and products using NXP Semiconductors products, and NXP Semiconductors accepts no liability for any assistance with applications or customer product design. It is customer's sole responsibility to determine whether the NXP Semiconductors product is suitable and fit for the customer's applications and products planned, as well as for the planned application and use of customer's third party customer(s). Customers should provide appropriate design and operating safeguards to minimize the risks associated with their applications and products.

NXP Semiconductors does not accept any liability related to any default, damage, costs or problem which is based on any weakness or default in the customer's applications or products, or the application or use by customer's third party customer(s). Customer is responsible for doing all necessary testing for the customer's applications and products using NXP Semiconductors products in order to avoid a default of the applications and the products or of the application or use by customer's third party customer(s). NXP does not accept any liability in this respect.

**Limiting values** — Stress above one or more limiting values (as defined in the Absolute Maximum Ratings System of IEC 60134) will cause permanent damage to the device. Limiting values are stress ratings only and (proper) operation of the device at these or any other conditions above those given in the Recommended operating conditions section (if present) or the Characteristics sections of this document is not warranted. Constant or repeated exposure to limiting values will permanently and irreversibly affect the quality and reliability of the device.

**Terms and conditions of commercial sale** — NXP Semiconductors products are sold subject to the general terms and conditions of commercial sale, as published at <http://www.nxp.com/profile/terms>, unless otherwise agreed in a valid written individual agreement. In case an individual agreement is concluded only the terms and conditions of the respective agreement shall apply. NXP Semiconductors hereby expressly objects to applying the customer's general terms and conditions with regard to the purchase of NXP Semiconductors products by customer.

**No offer to sell or license** — Nothing in this document may be interpreted or construed as an offer to sell products that is open for acceptance or the grant, conveyance or implication of any license under any copyrights, patents or other industrial or intellectual property rights.

**Export control** — This document as well as the item(s) described herein may be subject to export control regulations. Export might require a prior authorization from competent authorities.

**Quick reference data** — The Quick reference data is an extract of the product data given in the Limiting values and Characteristics sections of this document, and as such is not complete, exhaustive or legally binding.

**Non-automotive qualified products** — Unless this data sheet expressly states that this specific NXP Semiconductors product is automotive qualified, the product is not suitable for automotive use. It is neither qualified nor tested in accordance with automotive testing or application requirements. NXP Semiconductors accepts no liability for inclusion and/or use of non-automotive qualified products in automotive equipment or applications.

In the event that customer uses the product for design-in and use in automotive applications to automotive specifications and standards, customer (a) shall use the product without NXP Semiconductors' warranty of the

product for such automotive applications, use and specifications, and (b) whenever customer uses the product for automotive applications beyond NXP Semiconductors' specifications such use shall be solely at customer's own risk, and (c) customer fully indemnifies NXP Semiconductors for any liability, damages or failed product claims resulting from customer design and use of the product for automotive applications beyond NXP Semiconductors' standard warranty and NXP Semiconductors' product specifications.

**Translations** — A non-English (translated) version of a document is for reference only. The English version shall prevail in case of any discrepancy between the translated and English versions.

## 18.4 Trademarks

Notice: All referenced brands, product names, service names and trademarks are the property of their respective owners.

## 19. Contact information

For more information, please visit: <http://www.nxp.com>

For sales office addresses, please send an email to: [salesaddresses@nxp.com](mailto:salesaddresses@nxp.com)



**20. Contents**

<b>1</b>	<b>Product profile</b> . . . . .	<b>1</b>	<b>18.4</b>	<b>Trademarks</b> . . . . .	<b>22</b>
1.1	General description . . . . .	1	<b>19</b>	<b>Contact information</b> . . . . .	<b>22</b>
1.2	Features and benefits . . . . .	1	<b>20</b>	<b>Contents</b> . . . . .	<b>23</b>
1.3	Applications . . . . .	1			
1.4	Quick reference data . . . . .	1			
<b>2</b>	<b>Pinning information</b> . . . . .	<b>2</b>			
2.1	Pinning . . . . .	2			
2.2	Pin description . . . . .	2			
<b>3</b>	<b>Ordering information</b> . . . . .	<b>2</b>			
3.1	Ordering options . . . . .	2			
<b>4</b>	<b>Block diagram</b> . . . . .	<b>3</b>			
<b>5</b>	<b>Limiting values</b> . . . . .	<b>4</b>			
<b>6</b>	<b>Recommended operating conditions</b> . . . . .	<b>5</b>			
<b>7</b>	<b>Thermal characteristics</b> . . . . .	<b>5</b>			
<b>8</b>	<b>Characteristics</b> . . . . .	<b>6</b>			
<b>9</b>	<b>Dynamic behavior</b> . . . . .	<b>7</b>			
9.1	Dropout . . . . .	7			
9.2	Temperature dependency . . . . .	8			
9.3	Noise . . . . .	8			
9.4	Quiescent current . . . . .	9			
9.5	Line regulation . . . . .	10			
9.6	Load regulation . . . . .	11			
9.7	Start-up, inrush current . . . . .	12			
9.8	Power Supply Rejection Ratio (PSRR) . . . . .	12			
<b>10</b>	<b>Application information</b> . . . . .	<b>13</b>			
10.1	Capacitor values . . . . .	13			
<b>11</b>	<b>Test information</b> . . . . .	<b>13</b>			
11.1	Quality information . . . . .	13			
<b>12</b>	<b>Marking</b> . . . . .	<b>14</b>			
<b>13</b>	<b>Package outline</b> . . . . .	<b>15</b>			
<b>14</b>	<b>Packing information</b> . . . . .	<b>16</b>			
14.1	Packing methods . . . . .	16			
14.2	Carrier tape information . . . . .	16			
<b>15</b>	<b>Soldering</b> . . . . .	<b>17</b>			
<b>16</b>	<b>Soldering of SMD packages</b> . . . . .	<b>18</b>			
16.1	Introduction to soldering . . . . .	18			
16.2	Wave and reflow soldering . . . . .	18			
16.3	Wave soldering . . . . .	18			
16.4	Reflow soldering . . . . .	19			
<b>17</b>	<b>Revision history</b> . . . . .	<b>20</b>			
<b>18</b>	<b>Legal information</b> . . . . .	<b>21</b>			
18.1	Data sheet status . . . . .	21			
18.2	Definitions . . . . .	21			
18.3	Disclaimers . . . . .	21			

Please be aware that important notices concerning this document and the product(s) described herein, have been included in section 'Legal information'.

## Looking for pricing, stock, or lifecycle information?

Click below to explore more details on WIN SOURCE:

-  [View LD6835K/33PX on WIN SOURCE](#)
-  [NXP / Nexperia Information](#)

## Optimize Your Supply Chain with WIN SOURCE Solutions

-  Global Sourcing Solution
-  Obsolete Management
-  Cost Control Management
-  Shortage Management
-  Alternative Solution
-  Excess Inventory Management