



**THE DATASHEET OF
MP4603EF-LF-Z**



DESCRIPTION

The MP4603 is an integrated white LED driver. It uses MPS's patent-pending technology to drive the backlights for LCD TVs measuring 60-inches or larger, for LED string voltages up to 350V. This novel technology can leverage the LED drive power by regulating only a small portion of the LED drive voltage—together with a fixed high-voltage source, a low-voltage LED driver can drive high voltage LED strings. This method allows for a super-high power density, higher efficiency and lower cost due to the low voltage stress, higher switching frequencies, and smaller passive components.

The MP4603 is a current-mode-controlled buck-boost regulator. With a 12V input V_{INL} and a high voltage source V_{INH} , it can deliver a regulated voltage (V_{INH} to $V_{INH}+68V$) to drive a LED string with up to 100 LEDs. It can drive an external switch in series with the LED string to achieve over 1:1000 dimming ratio. Analog dimming can be applied at the same time to further improve the dimming ratio. Fault protections include LED open-string protection, output short-circuit protection, cycle-by-cycle peak current limiting, and thermal shutdown.

The MP4603 is available in SOIC16 package.

FEATURES

- Novel Power-Leverage-Control Technology
- Unique Step-Up/Down Operation
- Up to 99.5% Efficiency
- 0.5Ω Internal Power MOSFET
- Switching Frequency Synchronization
- Over 1:1000 Dimming Ratio
- Separate Analog and PWM Dimming
- ±5% 200mV Reference Voltage
- 10μA Shutdown Mode
- Cycle-by-Cycle Over-Current Protection
- Thermal Shutdown Protection
- LED String Open and Short Protection
- FAULT Output at LED Protection
- Output Short-Circuit Protection
- Available in SOIC16 Package

APPLICATIONS

- Large LCD Panels Backlighting
- High Power Street LED Lighting

All MPS parts are lead-free and adhere to the RoHS directive. For MPS green status, please visit MPS website under Products, Quality Assurance page.

"MPS" and "The Future of Analog IC Technology" are registered trademarks of Monolithic Power Systems, Inc.

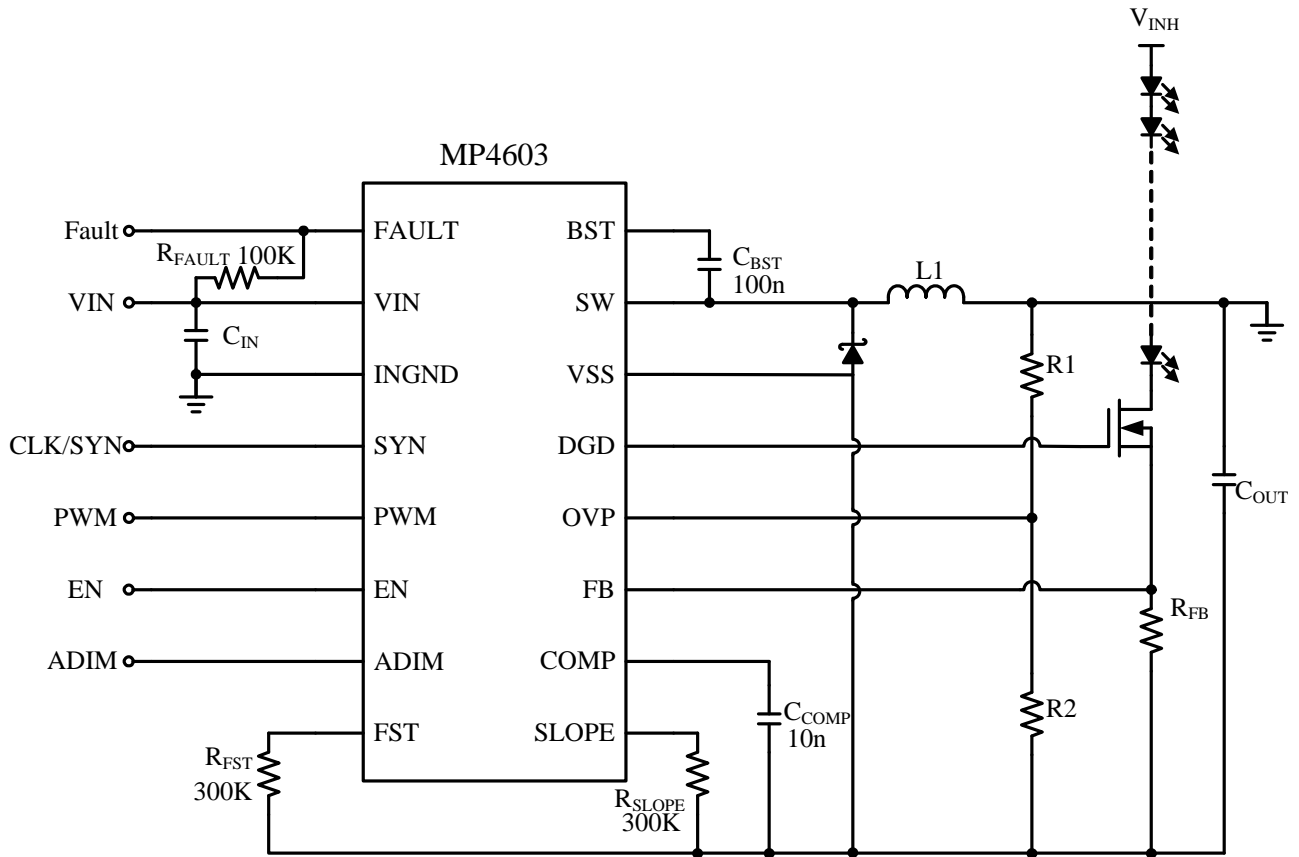
TYPICAL APPLICATION

ORDERING INFORMATION

Part Number	Package	Top Marking	Free Air Temperature (T _A)
MP4603ES*	SOIC16	MP4603ES	-20°C to +85°C

* For Tape & Reel, add suffix -Z (e.g. MP4603ES-Z);
 For RoHS Compliant Packaging, add suffix -LF (e.g. MP4603ES-LF-Z)

PACKAGE REFERENCE

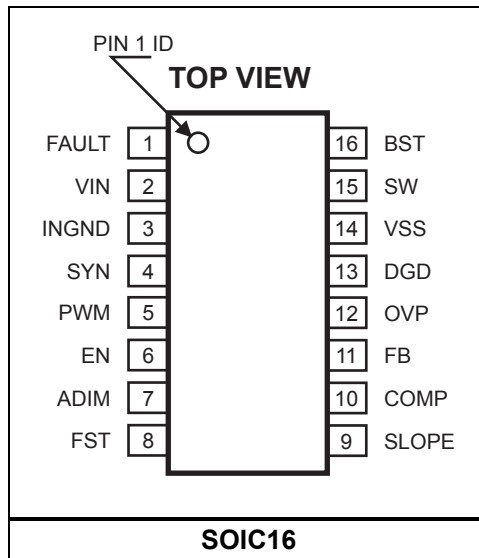

ABSOLUTE MAXIMUM RATINGS ⁽¹⁾

V _{VIN} – V _{SS}	-0.3V to 85V
V _{INGND} – V _{SS}	-0.3V to 85V
V _{SW} – V _{SS}	-0.3V to V _{IN} + 0.3V
V _{BST}	V _{SW} + 6V
V _{DGD} – V _{SS}	-0.3V to +12V
V _{VIN} – V _{OCP}	-0.3V to +6V
V _{OVP} , V _{FB} , V _{COM} , V _{FST} – V _{SS}	-0.3V to +6V
V _{ADIM} , V _{EN} , V _{PWM} , V _{SYN} – V _{INGND}	-0.3V to +6V
Continuous Power Dissipation (T _A = +25°C) ⁽²⁾	
SOIC16	1.6W
Junction Temperature	150°C
Lead Temperature	260°C
Storage Temperature	-65°C to +150°C

Recommended Operating Conditions ⁽³⁾

Supply Voltage V _{VIN} – V _{SS}	5V to 80V
V _{ADIM} , V _{EN} , V _{PWM} , V _{SYN} – V _{INGND}	0V to 5V
Maximum Junction Temp. (T _J)	+125°C

Thermal Resistance ⁽⁴⁾	θ _{JA}	θ _{JC}
SOIC16	80	30... °C/W

Notes:

- Exceeding these ratings may damage the device.
- The maximum allowable power dissipation is a function of the maximum junction temperature T_J (MAX), the junction-to-ambient thermal resistance θ_{JA}, and the ambient temperature T_A. The maximum allowable continuous power dissipation at any ambient temperature is calculated by P_D (MAX) = (T_J (MAX) - T_A) / θ_{JA}. Exceeding the maximum allowable power dissipation will cause excessive die temperature, and the regulator will go into thermal shutdown. Internal thermal shutdown circuitry protects the device from permanent damage.
- The device function is not guaranteed outside of the recommended operating conditions.
- Measured on JESD5 1-7, 4-layer PCB.

ELECTRICAL CHARACTERISTICS

$V_{VIN} = 12V$, PWM and AD Pins floating, $R_{FST} = 51k\Omega$, $T_A = +25^\circ C$, $V_{VSS} = V_{INGND} = 0V$, unless otherwise noted.

Parameters	Symbol	Condition	Min	Typ	Max	Units
FB Feedback Voltage	V_{FB}		190	200	210	mV
FB Input Current	I_{FB}	$V_{FB} = 0.2V$	-0.1		0.1	μA
VIN UVLO Rising	V_{VINTH}		3.6	4	4.3	V
VIN UVLO Hysteresis	V_{VINHYS}			400		mV
Shut Down Current	I_{off}	$V_{EN} = 0V$		10		μA
Supply Current (Quiescent)	I_Q	$V_{PWM} = 0V$, $V_{FB} = 250mV$		1.05	1.2	mA
Switch-On Resistance ⁽⁵⁾	$R_{DS(ON)}$			0.5		Ω
Switch Leakage	I_{SWLK}	$V_{VIN} = 80V$, $V_{EN} = 0V$, $V_{PWM} = 0V$, $V_{SW} = 0V$			1	μA
Switch Current Limit ⁽⁵⁾	I_{S_MAX}			2.5		A
Oscillator Frequency	f_{SW}	FST pin open	0.65	0.9	1.2	MHz
		$R_{FST} = 200k\Omega$	180	280	390	kHz
FST Output Voltage	V_{FST}		1	1.1	1.2	V
Fold-back Frequency	f_{SWFB}	$V_{FB} = V_{OVP} = 0V$, FST pin open		160		kHz
		$V_{FB} = V_{OVP} = 0V$, $R_{FST} = 200k\Omega$		40		
Slope Compensation	S_{SLOPE}	SLOPE pin open	0.3	0.5	0.7	V/ μs
		$R_{SLOPE} = 200k\Omega$	0.12	0.17	0.235	
SLOPE Pin Output Voltage	V_{SLOPE}		1	1.1	1.2	V
Maximum Duty Cycle	D_{MAX}	$V_{FB} = 0.15V$, FST pin open		88		%
Minimum ON-Time ⁽⁵⁾	t_{ON}			270		ns
SYN Input Current	I_{SYN}	$V_{SYN} = 3.3V$		400		μA
		$V_{SYN} = 0V$		-750		
Frequency Synchronization Range ⁽⁵⁾	f_{SW_SYN}		0.1		2	MHz
PWM Dimming OFF Threshold	V_{PWML}	V_{PWM} Falling			1.65	V
PWM Dimming ON Threshold	V_{PVMH}	V_{PWM} Rising	2.2			V
PWM Dimming Frequency			100		50k	Hz
Minimum Analog Dimming Threshold	V_{ADMIN}	$V_{FB} = 5mV$		0		mV
Maximum Analog Dimming Threshold	V_{ADMAX}	$V_{FB} = 200mV$		1.2		V
ADIM Input Current		$V_{ADIM} = 3.3V$		36		μA
		$V_{ADIM} = 0V$		-3.5		
EN OFF Threshold	V_{ENL}	V_{EN} Falling			0.9	V
EN ON Threshold	V_{ENH}	V_{EN} Rising	1.5			V
EN Input Current	I_{EN}	$V_{EN} = 3.3V$		3.8		μA

ELECTRICAL CHARACTERISTICS *(continued)*

$V_{VIN} = 12V$, PWM and AD Pins floating, $R_{FST}=51k\Omega$, $T_A = +25^\circ C$, $V_{VSS}=V_{INGND}=0V$, unless otherwise noted.

Parameters	Symbol	Condition	Min	Typ	Max	Units
Dim Gate Driver Sourcing Current	I_{DGD+}	$V_{DGD}-V_{SS} = 0V$, $V_{PWM}=3V$		-25		mA
Dim Gate Driver Sinking Current	I_{DGD-}	$V_{DGD}-V_{SS}=10V$, $V_{PWM}=1.5V$		45		mA
LED Open OV Threshold	V_{OVPTH}			1.2		V
LED Short Threshold for Immediate Latch-Off	V_{FBS}			600		mV
LED Short Delay for Latch-Off	T_{D_FBS}	$300mV < V_{FBS} < 600mV$		450		μs
Thermal Shutdown ⁽⁵⁾				150		$^\circ C$
Thermal Shutdown Hysteresis ⁽⁵⁾				20		$^\circ C$

Note:

5) Guaranteed by design.

TYPICAL CHARACTERISTICS

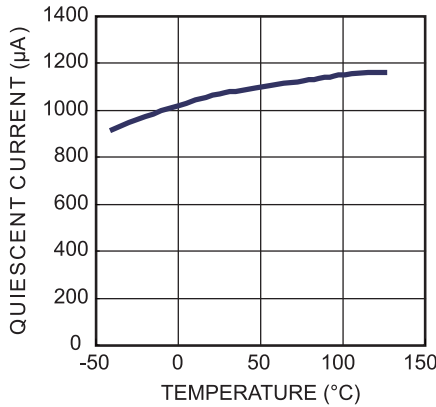
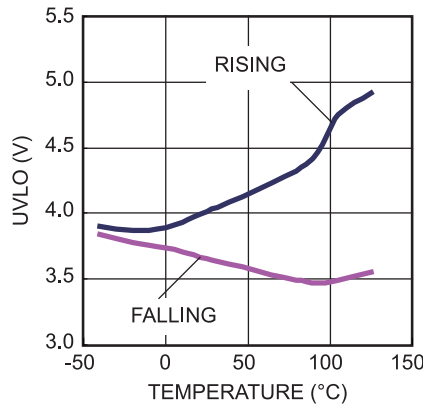
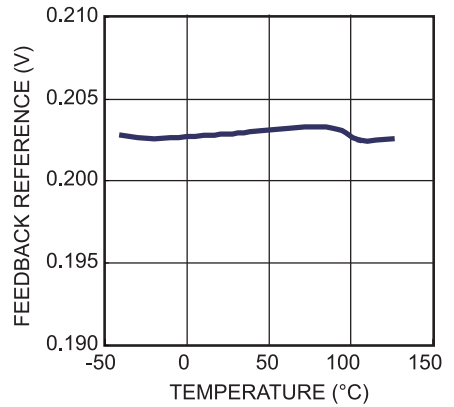
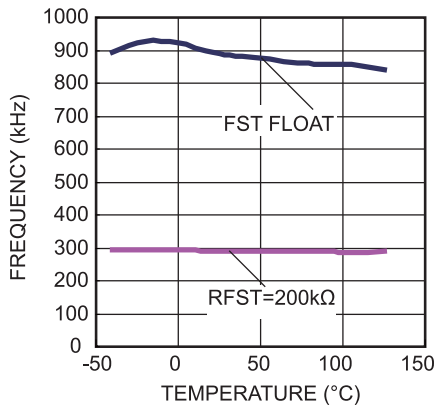
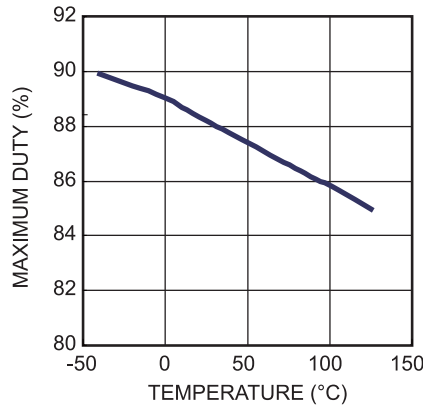
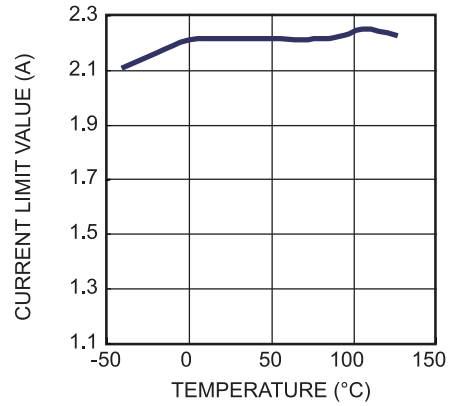
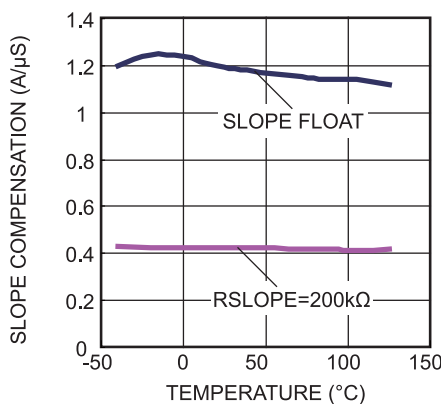
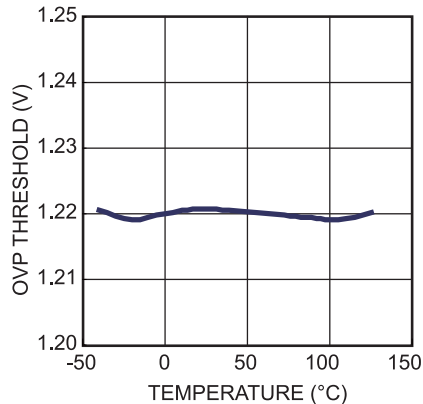
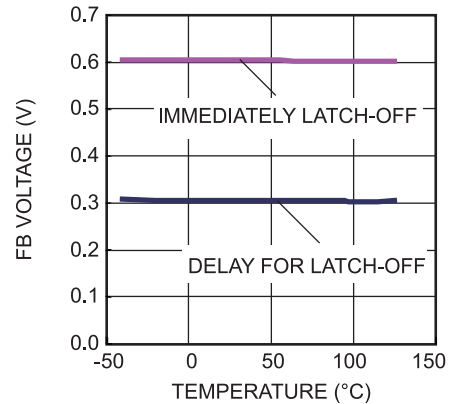
Quiescent Current vs. T_J

UVLO vs. T_J

Feedback Reference vs. T_J

Frequency vs. T_J

Maximum Duty (FST Float) vs. T_J

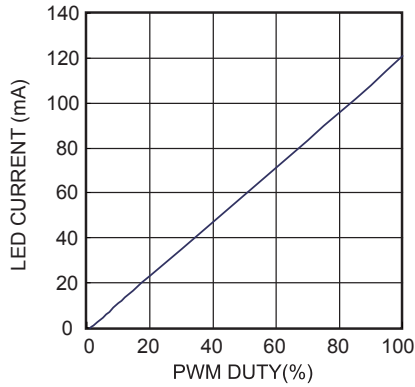
Current Limit Value vs. T_J

Slope Compensation vs. T_J

OVP Threshold vs. T_J

SLP Threshold vs. T_J

TYPICAL PERFORMANCE CHARACTERISTICS

Performance waveforms are tested on the evaluation board of the Design Example section.

$V_{IN} = 12V$, $V_{INH} = 125V$, $V_{LED}=180V$ $I_{LED} = 120mA$, $T_A = 25^\circ C$, unless otherwise noted.

PWM Dimming Curve



Analog Dimming Curve

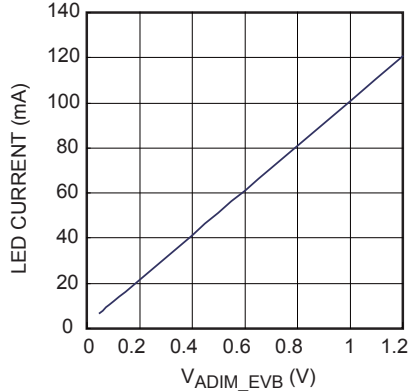

Steady State

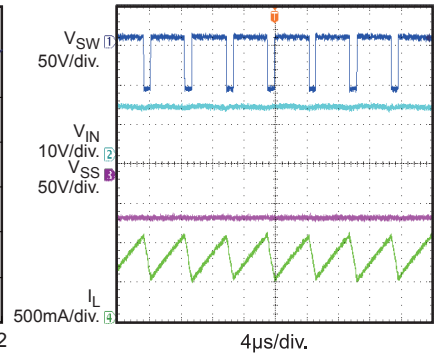

V_{IN} Start

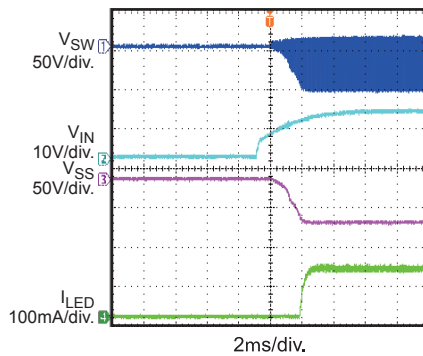

EN Start

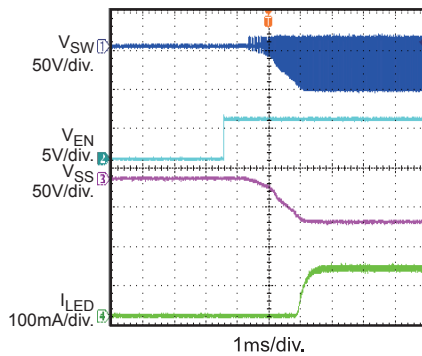

PWM Dimming

$f_{PWM}=200Hz$, $D_{PWM}=50\%$

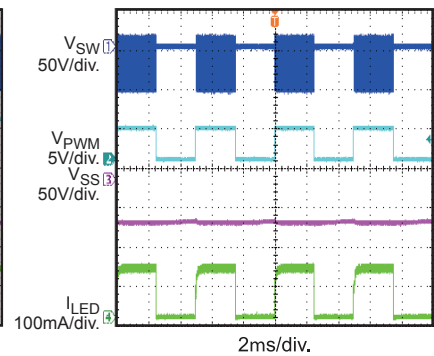

Open LED Load @ Working

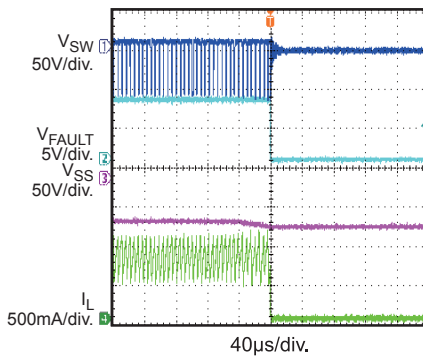

Short LED- to GND @ Working

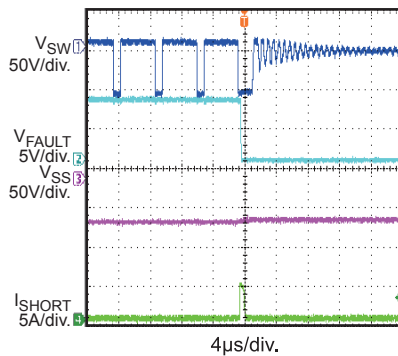

PIN FUNCTIONS

Pin # SOIC16	Name	Description
1	FAULT	Fault Condition Output. Open drain with reference to INGND. FAULT is high-Z during normal operation, and pulled to INGND when LED short protection or LED open protection trigger.
2	VIN	Positive Voltage Input. Requires a decoupling capacitor to prevent large input-voltage spikes.
3	INGND	Input Ground Reference.
4	SYN	Frequency Synchronization Input. The switching frequency can be synchronized with an external clock. Multiple ICs' frequencies can also be synchronized without the external clock by connecting all the SYN pins together. They follow the highest set frequency.
5	PWM	PWM Dimming Input. Apply a 100Hz to 50kHz square wave signal with amplitude greater than 2.2V. The PWM pin voltage is high if left floating.
6	EN	Enable Input Pin. A voltage greater than 1.5V will turn on the chip.
7	ADIM	Analog Dimming Input. A voltage in range of 0V to 1.2V on ADIM pin adjusts the LED current from 0 to 100%. The ADIM pin voltage is high (about 3.3V) if left floating.
8	FST	Frequency Set. A resistor from FST to VSS sets the switching frequency if there is no SYN input. If left open, switching frequency reverts to an internal default value.
9	SLOPE	Programmable Slope Compensation. Connect a resistor from SLOPE to VSS to set the slope-compensation peak amplitude. If left open, slope compensation reverts to an internal default value.
10	COMP	Error Amplifier Output. Connect a capacitor $\geq 1nF$ from the COMP pin to VSS to improve the stability and to provide a soft-start on start-up or for PWM dimming.
11	FB	LED Current Feedback. The MP4603 regulates the voltage across the current sensing resistor between FB and VSS with 200mV. If the FB voltage exceeds 300mV for 450 μ s or exceeds 600mV, LED short protection triggers.
12	OVP	Over Voltage Protection. Use one external resistor voltage divider from the output to VSS to program the OVP threshold. This voltage references VSS. When the OVP pin voltage reaches the 1.2V threshold, the switch turns off and the IC latches off. When the OVP pin voltage falls below 0.4V and the FB pin voltage is less than 0.1V, the chip frequency folds back. Program the OVP pin voltage from 0.4V to 1.2V for normal operation.
13	DGD	LED Dimming-Switch Gate Drive Output.
14	VSS	Negative Voltage Output. The voltage reference for OVP, FB, COMP, SLOPE, DGD and FST.
15	SW	Switch Output. The source of the internal MOSFET switch. Connect to the power inductor and cathode of the Schottky rectifier.
16	BST	Bootstrap. Connect a capacitor between the SW and BST pins to form a floating supply across the power switch driver.

OPERATION

The MP4603 is a current mode regulator. The sensing resistor senses the LED current and the signal goes an error amplifier, which regulates it to 200mV through an internal compensation network—The COMP pin is the output of the error amplifier. The inductor peak current is proportional to the COMP voltage. Increasing the COMP voltage increases the current delivered to the output.

LED Open Protection

If the LED is open, there is no voltage on the FB pin. The duty cycle increases until $V_{OVP}-V_{VSS}$ reaches the shutdown threshold. The top switch turns off, and the IC latches off. At LED open protection, the Fault pin goes low.

LED Short Protection

If the FB voltage exceeds 600mV, the IC immediately latches off and DGD goes low. If the FB voltage exceeds 300mV for around 450 μ s, IC latches off and DGD goes low. The EN pin must reset to restart the IC. The Fault pin goes low when the IC latches off.

Dimming Control

The MP4603 allows for both Analog and PWM dimming. The analog dimming voltage range on ADIM goes from 0V to 1.2V to change the LED current from 0% to 100% of the maximum LED current. If the voltage on the ADIM pin exceeds 1.2V or is floating, LED current goes to its maximum.

PWM dimming uses a square-wave signal with a 100Hz-to-50kHz frequency range and an amplitude over 2.2V applied to the PWM pin. PWM dimming can achieve over 1:1000 dimming ratio with PWM frequency less than 200Hz

During the PWM dimming OFF interval, an internal switch disconnects the COMP pin capacitor from the output of the error amplifier: This holds the COMP voltage during the PWM OFF interval and increases the LED current response speed to achieve a high dimming ratio.

Combine PWM and analog dimming to increase the dimming ratio. Apply a 100Hz to 50kHz PWM signal on PWM pin and a analog dimming signal in range of 0V to 1.2V on ADIM pin.

APPLICATION INFORMATION

The MP4603 is a buck-boost LED driver. Its novel power leverage control technology provides a highly efficient, low-cost solution for LCD TV LED drivers. It has a high bus voltage and a low supply voltage (typically 12V or 24V, up to 60V) to drive LED backlight strings of >350V for LCD TVs measuring 60-inch or more.

Setting the LED Current

An external resistor (R_{FB}) sets the maximum LED current as per:

$$R_{FB} = \frac{0.200V}{I_{LED}}$$

Setting the Switching Frequency

An external resistor R_{FST} can set the switching frequency (f_s) as per:

$$f_s = 0.95MHz \cdot \frac{60k}{R_{FST}}$$

This equation applies to a programmable frequency range between 200kHz and 2MHz.

If FST pin is floating or R_{FST} exceeds 400k Ω , the switching frequency is set to default value of 0.9MHz.

Setting the Slope Compensation

The MP4603 employs peak-current-mode control, which needs slope compensation to avoid sub-harmonic oscillation when the duty cycle exceeds 50%.

The current loop has effective sense resistance of 0.4 Ω . Given a desired input/output voltage relationship, estimate the sense current ramp-down slope as:

$$S_{DOWN} = \frac{V_L}{L} \cdot 0.4V/\mu s$$

Where V_L is the voltage across the inductor in volt; and L is the inductor value in μH .

Ensuring current loop stability requires a compensation slope of at least half of the ramp-down slope:

$$S_{SC} \geq \frac{1}{2} S_{DOWN}$$

An external resistor (R_{SLOPE}) can set the slope compensation for the current loop as per:

$$S_{SC} = 0.6 \frac{V}{\mu s} * \frac{60k}{R_{SLOPE}}$$

The equation is effective only for a resistor range from 20k Ω to 400k Ω for R_{SLOPE} .

If SLOPE pin is floating or R_{SLOPE} exceeds 400k Ω , the slope compensation is set to default value of 0.5V/ μs .

Selecting the Inductor

The input voltage, output voltage, and LED current factor into inductor selection. In addition, select the inductor so that the circuit always operates in continuous current mode (CCM). Estimate the inductor value using the following equation:

$$L = \frac{V_{IN} \cdot V_{OUT}}{f_s \cdot (V_{IN} + V_{OUT}) \cdot \Delta I_L}$$

Where ΔI_L is the inductor peak-to-peak current ripple. Design ΔI_L somewhere around 40% to 60% of the inductor average current, which is:

$$I_{L_AVG} = I_{LED} \cdot \left(1 + \frac{V_{OUT}}{V_{IN}}\right)$$

Select an inductor that does not saturate at the maximum peak current, which is:

$$I_{L_PK} = I_{L_AVG} + 0.5 \cdot \Delta I_L$$

Selecting the Input Capacitor

The input capacitor reduces the surge current drawn from the input supply and the switching noise from the device. Use ceramic capacitors with X5R or X7R dielectrics because they have low ESR values and small temperature coefficients. Select a sufficiently-large capacitance to limit the input voltage ripple (ΔV_{IN}), which is normally less than 5%-10% of the DC value.

$$C_{IN} > \frac{I_{L_AVG} \cdot V_{OUT}}{f_s \cdot \Delta V_{IN} \cdot (V_{IN} + V_{OUT})}$$

Selecting the Output Capacitor

The output capacitor normally limits the output voltage ripple (ΔV_{OUT}) to less than 1%-to-5% of the DC value, and ensures a stable feedback loop. Select an output capacitor value with low impedance at the switching frequency. Use ceramic capacitors with X5R or X7R dielectrics for their low ESR characteristics.

$$C_{OUT} > \frac{I_{LED} \cdot V_{OUT}}{f_s \cdot \Delta V_{OUT} \cdot (V_{IN} + V_{OUT})}$$

Setting the Over Voltage Protection

The output voltages of some converters, such as buck-boost and boost converters, can rise to very high levels without a limiting function. Over-voltage protection (OVP) limits the output voltage to below the operating rating. Use a voltage divider to set the OVP point.

$$V_{OVP} = 1.2V \cdot \left(1 + \frac{R_1}{R_2}\right)$$

Where R_1 and R_2 are the voltage divider (refer the TYPICAL APPLICATION). For most applications, set the OVP point around 10% to 30% higher than the output voltage. Check that the set OVP point will not exceed the operation rating.

FAULT Condition Output

The MP4603 has an open drain output as a FAULT indicator. Under normal conditions, FAULT is a high-Z output and can be set to any desired voltage with external resistors. However, if V_{FB} exceeds V_{SS} by 600mV, or V_{FB} exceeds V_{SS} by 300mV for $\sim 450\mu s$, or OVP triggers at 1.2V, FAULT drops to the INGND level. The R_{dson} for this pull down switch is $\sim 100\Omega$.

PC Board Layout

Place the high-current paths (V_{SS} , V_{IN} and SW) very close to the device with short, direct, and wide traces. Place the input capacitor as close as possible to the V_{IN} and V_{SS} pins. Place the external feedback resistors next to the FB pin. Keep the switch node traces short and far away from the feedback network.

Pay attention to the layout of the high frequency switching loop, which should be placed as small as possible.

For buck applications, the high frequency switching loop is composed of the input capacitor, the internal switch of IC (V_{IN} pin to SW pin) and the diode. Place the input capacitor and the diode close to the IC.

For buck-boost applications, the high frequency switching loop is composed of the input capacitor, the internal switch, the diode and the output capacitor. Place the input and output capacitors close together, close to the IC, and to the diode.

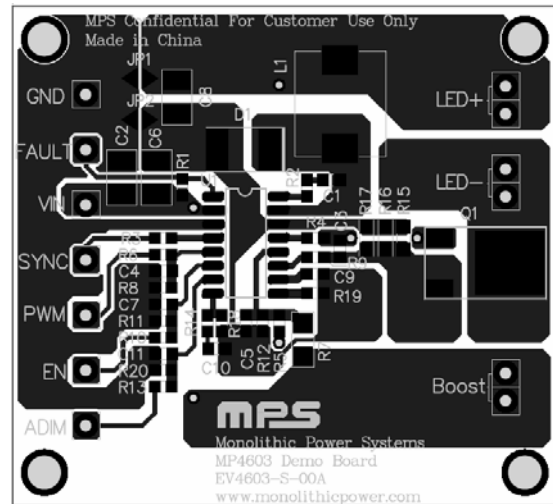

Top Layer

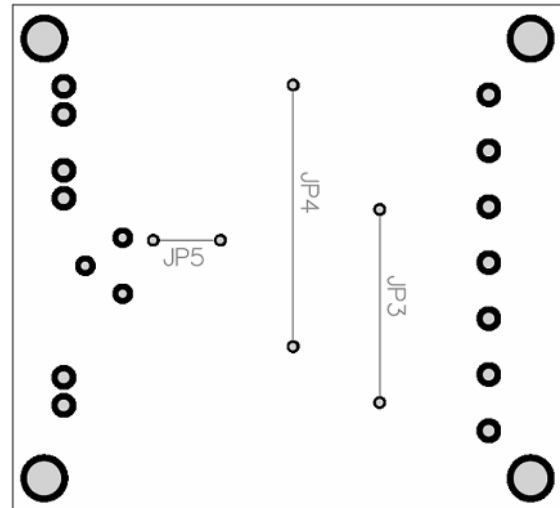

Bottom Layer

Figure 2: PCB Layout

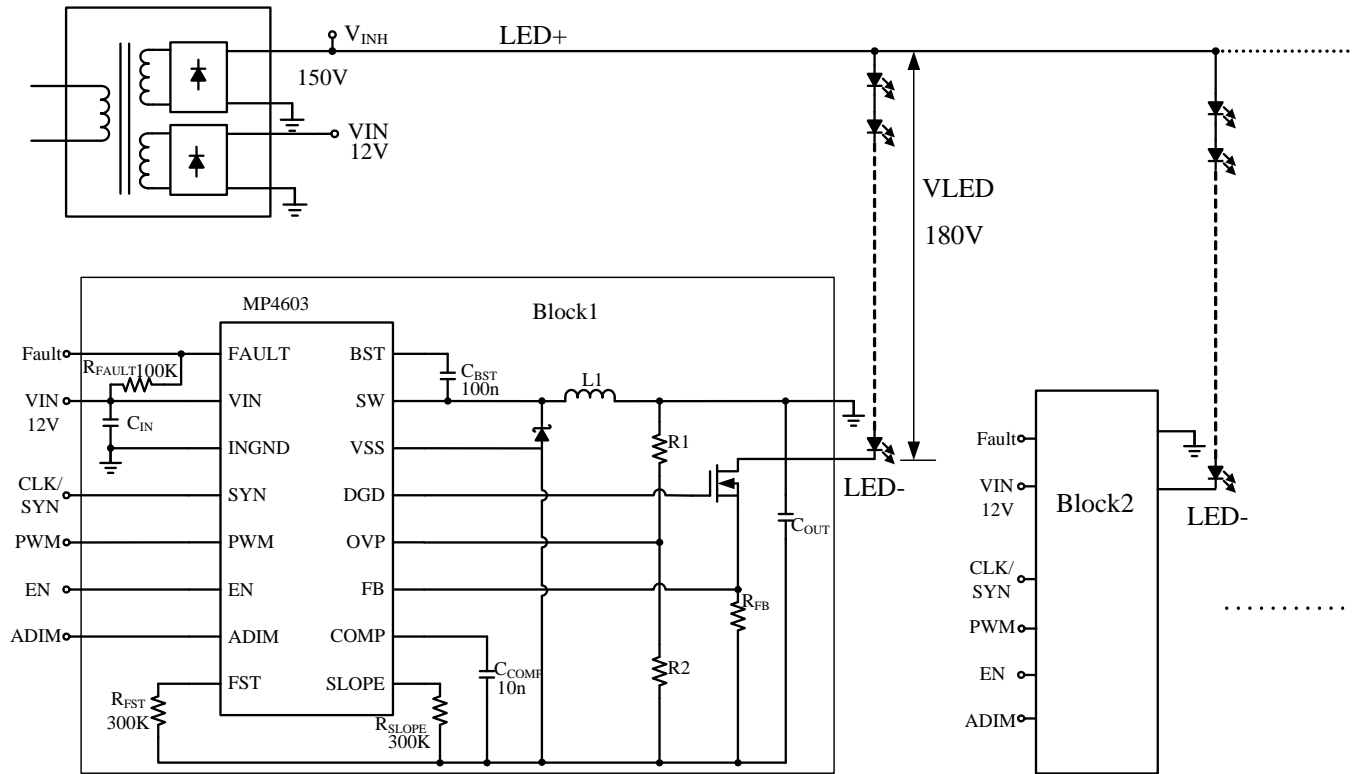
TYPICAL APPLICATION CIRCUITS

Figure 3: White LED Driver for TV Applications

Design Example

This design example shows an LCD TV LED backlight application. Figure 4 shows the system power structure block diagram. MPS's HFC0100 flyback controller controls the flyback, offering 2 outputs: $12V_{IN}$ and V_{INH} . The high output, V_{INH} , provides a bias voltage (less

than the LED string voltage) for all LED strings and connects to the anodes. The low output, $12V_{IN}$, is about 12V and supplies the MP4603 LED driver; the MP4603 generates a negative voltage and connects to the cathode of the LED strings to drive the LED strings.

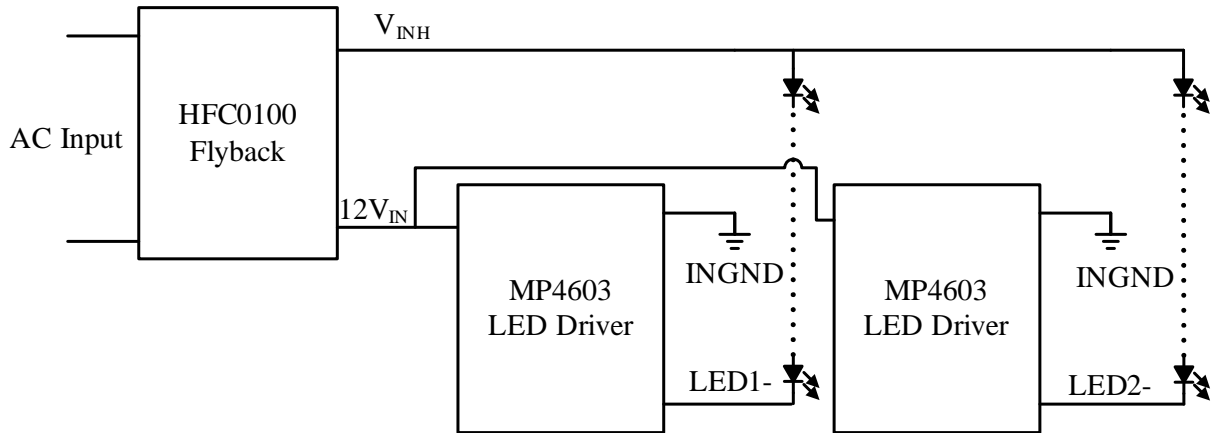

Figure 4: System Power Block Diagram

Specifications

Flyback Output:

V_{INH} = typical 145V (140V to 160V): cross-regulation in the multiple output flyback is the primary cause of the large tolerance.

$12V_{IN}$ is 12V;

Output:

2 outputs of 120mA for every string

LED voltage is typical 180V (165V to 195V)

Switching frequency:

~200kHz

Protections:

- Open LED string protection
- Short LED string protection

MP4603 Operating Range:

- Input voltage = 12V
- Output voltage = -5V to -55V
- LED current = 120mA.

Figure 5 shows the schematic of the MP4603 LED driver stage. JP1 is short and JP2 is open.

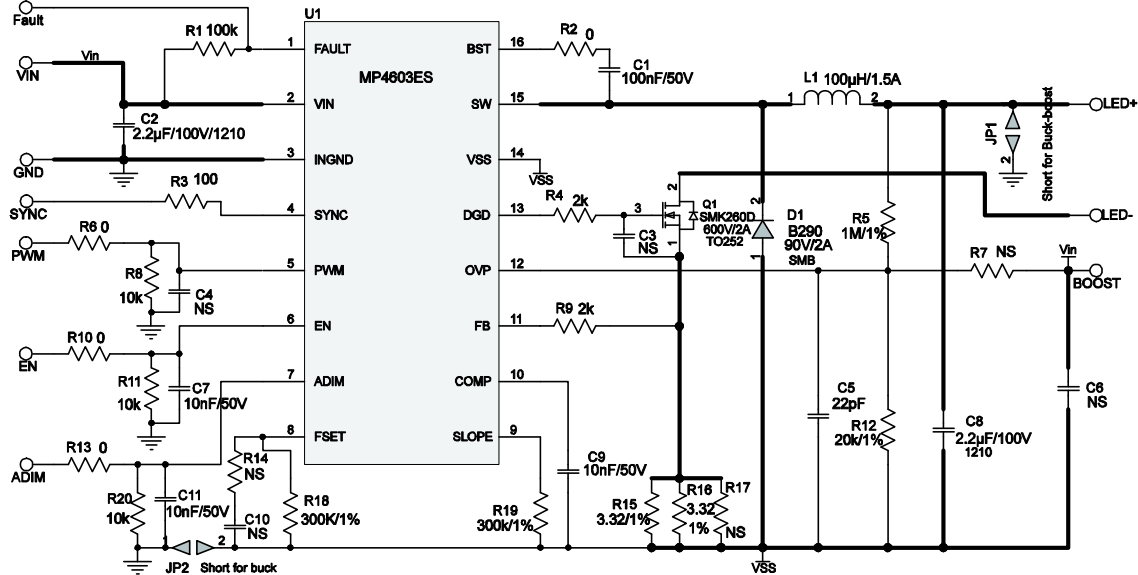

Figure 5: LED Driver Schematic Used for Evaluation (EV4603-S-00A)

Setting Current Sense Resistor

The sense resistor R_{FB} is:

$$R_{FB} = \frac{0.200V}{I_{LED}}$$

Use two 3.32Ω resistor in parallel (R15 and R16) as the LED current sensor resistor.

Setting the Frequency Set Resistor

The following equation determines the frequency set resistor, R18:

$$R18 = \frac{0.95MHz \cdot 60k}{f_s}$$

Select 300kΩ to set the switching frequency to about 200kHz.

Selecting the Inductor

Select an inductor such that the circuit always operates in CCM as per the following equation:

$$L1 = \frac{V_{IN_min} \cdot V_{OUT_max}}{f_s \cdot (V_{IN_min} + V_{OUT_max}) \cdot \eta \cdot I_{LED} \left(1 + \frac{V_{OUT_max}}{V_{IN_min}}\right)}$$

Where η is about 40% to 60%. Select an inductance of 100µH and the inductor peak-to-peak current of 0.49A.

Select an inductor that does not saturate at the maximum peak current, which is:

$$I_{L_PK} = I_{L_AVG} + 0.5 \cdot \Delta I_L$$

Select L1=100µH with a saturation current of 1.5A

Setting the Slope Compensation

The voltage across the inductor in the buck-boost converter is the output voltage. The maximum slope compensation is:

$$S_{DOWN} = \frac{V_{OUT_max}}{L} \cdot 0.4V/\mu s$$

To ensure current-loop stability, select a compensation slope that is at least half of the needed ramp-down slope:

$$S_{SC} \geq \frac{1}{2} S_{DOWN}$$

$S_{SC} \geq 0.11V/\mu s$. Use the slope compensation resistor R_{SLOPE} to set the slope compensation for the current loop as per the following equation:

$$R19 = 60k\Omega \cdot \frac{0.6V/\mu s}{S_{SC}}$$

Based on this equation, the slope compensation resistor cannot exceed 330kΩ.

Select R19=300kΩ as the compensation resistor.

Selecting the Input and Output Capacitor

Estimate the input capacitor and output capacitor using the following equations.

$$C_{IN} > \frac{I_{L_AVG} \cdot V_{OUT}}{f_s \cdot \Delta V_{IN} \cdot (V_{IN} + V_{OUT})}$$

$$C_{OUT} > \frac{I_{LED} \cdot V_{OUT}}{f_s \cdot \Delta V_{OUT} \cdot (V_{IN} + V_{OUT})}$$

Where ΔV_{IN} is about 5%-to-10% of the input voltage, and ΔV_{out} is about 1%-to-5% of the output voltage. Select C2=2.2μF ceramic capacitor as the input capacitor and C8=2.2μF as the output capacitor

Setting the Over Voltage Protection

Set the OVP point is about 1.1x-to-1.2x of the output voltage so that the OVP point is about 60V to 66V.

$$V_{OVP} = 1.2V \cdot \left(1 + \frac{R_5}{R_{12}}\right)$$

Select R12=20kΩ and R5=1MΩ; the OVP point is 63V.

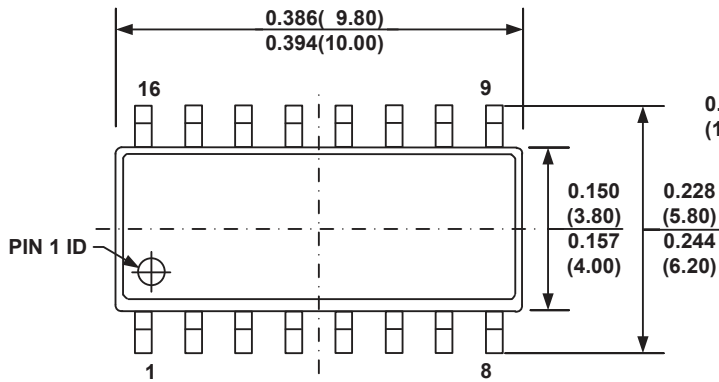
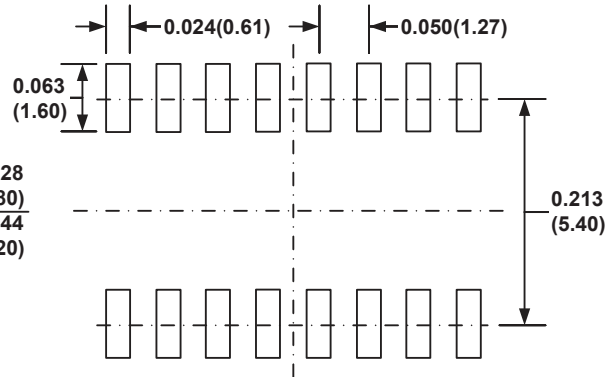
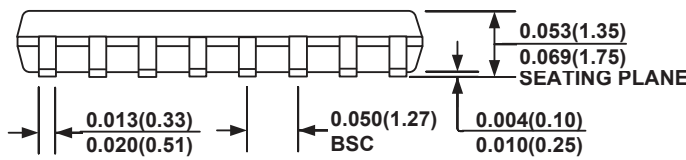
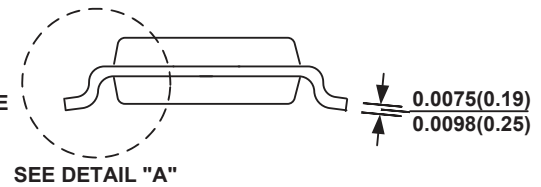
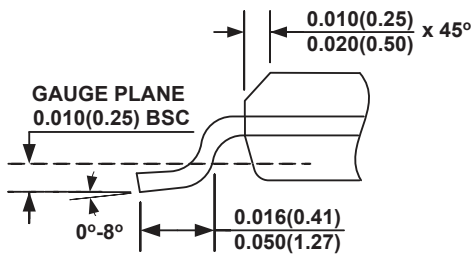
PACKAGE INFORMATION
SOIC16

TOP VIEW

RECOMMENDED LAND PATTERN

FRONT VIEW

SIDE VIEW

DETAIL "A"
NOTE:

- 1) CONTROL DIMENSION IS IN INCHES. DIMENSION IN BRACKET IS IN MILLIMETERS.
- 2) PACKAGE LENGTH DOES NOT INCLUDE MOLD FLASH, PROTRUSIONS OR GATE BURRS.
- 3) PACKAGE WIDTH DOES NOT INCLUDE INTERLEAD FLASH OR PROTRUSIONS.
- 4) LEAD COPLANARITY (BOTTOM OF LEADS AFTER FORMING) SHALL BE 0.004" INCHES MAX.
- 5) DRAWING CONFORMS TO JEDEC MS-012, VARIATION AC.
- 6) DRAWING IS NOT TO SCALE.

NOTICE: The information in this document is subject to change without notice. Please contact MPS for current specifications. Users should warrant and guarantee that third party Intellectual Property rights are not infringed upon when integrating MPS products into any application. MPS will not assume any legal responsibility for any said applications.

Looking for pricing, stock, or lifecycle information?

Click below to explore more details on WIN SOURCE:

- [⊖ View MP4603EF-LF-Z on WIN SOURCE](#)
- [⊖ Monolithic Power Systems Inc. Information](#)

Optimize Your Supply Chain with WIN SOURCE Solutions

- ✓ Global Sourcing Solution
- ✓ Obsolete Management
- ✓ Cost Control Management
- ✓ Shortage Management
- ✓ Alternative Solution
- ✓ Excess Inventory Management