



**THE DATASHEET OF
SP6265JEK1-L/TR**



Dual Low-Dropout CMOS Voltage Regulator

Features

- Very Low Dropout Voltage
- Guaranteed 150mA for Each Output
- Accurate to Within 1.5% for Both Outputs
- Typical 70 μ A Quiescent Current
- Over-Temperature Shutdown
- Current Limiting
- Noise Reduction Bypass Cap
- Power-Saving Shutdown Mode
- Available in Lead Free, RoHS Compliant Packaging: 6Pin TSOT-26 & 8Pin DFN

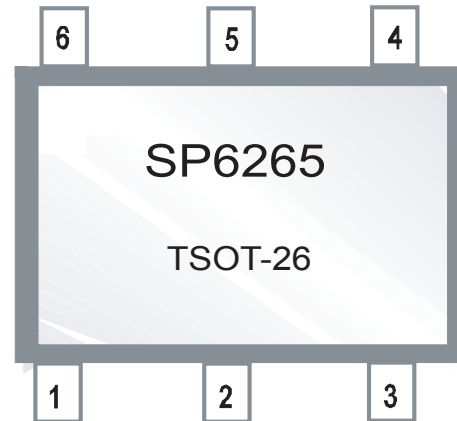

TSOT-26
Top View

Applications

- Cellular Phones
- Palm / Notebook
- Battery Powered Equipment
- Handheld Devices

DESCRIPTION

The SP6265 dual, low dropout, linear regulators operate up to 5.5V input and deliver up to 150mA/150mA output current per regulator. It has a bypass pin option which allows users to decouple the bandgap reference for reducing the output noise. Low dropout voltage and low quiescent current (70 μ A typ.) make them ideal for battery powered applications. The SP6265 is available with a wide variety of standard voltage options and can be trimmed to 1.5% accuracy. For protection purposes, SP6265 has a thermal shutdown feature to prevent device failure under the "worst" operating conditions.

TYPICAL APPLICATION CIRCUITS

SP6265 without Bypass

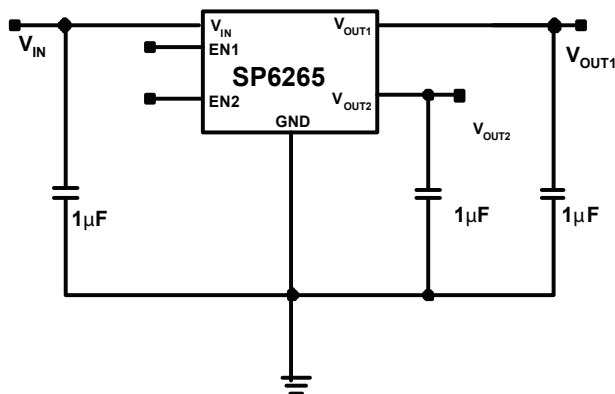

SP6265 with Bypass

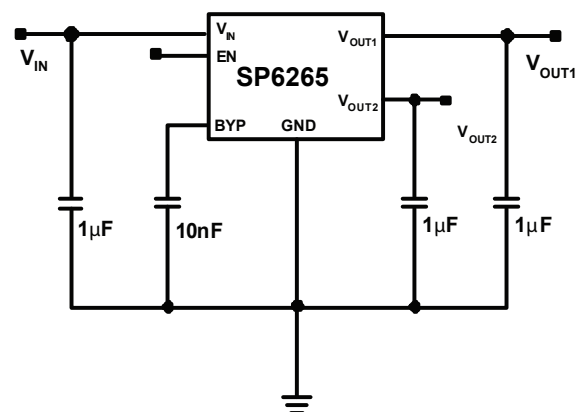

ABSOLUTE MAXIMUM RATINGS

These are stress ratings only and functional operation of the device at these ratings or any other above those indicated in the operation sections of the specifications below is not implied. Exposure to absolute maximum rating conditions for extended periods of time may affect reliability.

Input Voltage.....	6V
Output Current.....	$P_D / [2V_{IN} - (V_{OUT1} + V_{OUT2})]$ mA
Output Voltage.....	GND- 0.3 to $V_{IN} + 0.3$ V
ESD Classification.....	HBM C:4000V+
Ambient Temperature Range (T_A).....	-40°C to 85°C
Junction Temperature Range (T_J).....	-40°C to 85°C
Lead Temperature (Soldering, 10 sec).....	350°C
Maximum Junction Temperature.....	150°C

Thermal Resistance θ_{JC}	
TSOT 26.....	81°C/W
DFN-8.....	17°C/W
Thermal Resistance θ_{JA}	
TSOT 26.....	260°C/W
DFN-8.....	125°C/W
Internal Power Dissipation P_D	
TSOT 26.....	400mW
DFN-8.....	125mW

ELECTRICAL SPECIFICATIONS

Unless specified: $T_J = 25^\circ\text{C}$, $V_{IN} = \text{Higher } V_{OUT} + 1\text{V}$, $I_{OUT1} = I_{OUT2} = 1\text{mA}$, $C_{IN} = C_{OUT} = 1.0\mu\text{F}$, $V_{EN1} = V_{EN2} = V_{IN}$
 Typical values are at $T_J = 25^\circ\text{C}$

Parameter	Symbol	Test Condition	Min	Typ	Max	Units		
IN								
Input Supply Voltage	V_{IN}		Note1		5.5	V		
Quiescent Current	I_Q			70	160	μA		
OUT1, OUT2								
Output Voltage	V_O	$I_{OUT} = 1\text{mA}$	-1.5	V_{OUT}	1.5	%		
		$0\text{mA} < I_{OUT} \leq 150\text{mA}$ $V_{OUT} + 1\text{V} < V_{IN} < 5.5\text{V}$ $T_J = 0^\circ\text{C to } +125^\circ\text{C}$	-2		2			
Line Regulation	REG_{LINE}	$V_{OUT} + 1\text{V} < V_{IN} < 5.5\text{V}$ $I_{OUT} = 1\text{mA}$	$T_J = 25^\circ\text{C}$	-0.2	0.2	%/V		
			$T_J = -40^\circ\text{C to } +125^\circ\text{C}$	-0.25	0.25			
Load Regulation	REG_{LOAD}	$1\text{mA} < I_{OUT}$	$T_J = 0^\circ\text{C to } +125^\circ\text{C}$	-0.005	+0.0025	0.005	%/mA	
Dropout Voltage	V_{DROP}	$I_{OUT1} = I_{OUT2} = 150\text{mA}$ $V_O = V_{O(NOM)} - 2\%$ $V_{O(NOM)} < 2.5\text{V}$	$T_J = 0^\circ\text{C to } +125^\circ\text{C}$		350	mV		
				$I_{OUT1} = I_{OUT2} = 150\text{mA}$ $V_O = V_{O(NOM)} - 2\%$ $V_{O(NOM)} \geq 2.5\text{V}$		300	mV	
Current Limit	I_{LIM}			180	600	mA		
Short Circuit Current	I_{SC}	Each Channel			200		350	
Ripple Rejection	PSRR					dB		
							$f = 100\text{Hz}$, $C_{BYP} = 10\text{nF}$, $I_{OUT} = 1\text{mA}$	55
							$f = 1\text{kHz}$, $C_{BYP} = 10\text{nF}$, $I_{OUT} = 1\text{mA}$	55
		$f = 10\text{kHz}$, $C_{BYP} = 10\text{nF}$, $I_{OUT} = 1\text{mA}$			48			
Output Voltage Noise	e_n					μVRMS		
							$f = 1\text{kHz to } 100\text{kHz}$ $C_{BYP} = 10\text{nF}$, $C_{OUT} = 1\mu\text{F}$	550
		$f = 1\text{kHz to } 100\text{kHz}$ $C_{BYP} = 10\text{nF}$, $C_{OUT} = 1\mu\text{F}$			5.5	$\mu\text{V}/\sqrt{\text{Hz}}$		
EN1, EN2								
Enable Input Threshold	V_{EH}	$V_{IN} = 2.4\text{V to } 5.5\text{V}$	$T_J = -40^\circ\text{C to } +125^\circ\text{C}$			V		
	V_{EL}	$V_{IN} = 2.4\text{V to } 5.5\text{V}$					0.4	
EN Input Bias Current	I_{EL}	$V_{IN} = 5.0\text{V}$		-1	0.5	1		
	I_{EH}						EN=0V	μA
		EN=5V						
Shutdown Current	I_{SHDN}	$V_{IN} = 5.0\text{V}$, EN1=EN2=0V			0.3	1		
BYP								
Start-Up Rise Time		$C_{BYP} = 10\text{nF}$			1.25	ms		
Over Temperature Protection								
Over Temperature Shutdown	OTS				150	$^\circ\text{C}$		
Over Temperature Hysteresis	OTH				20	$^\circ\text{C}$		

Note1: $V_{IN(min)} = V_{OUT2} + V_{Dropout}$

SP6265A, B TSOT-26 Package with Bypass

Pin Number	Pin Name	Description
1	V _{OUT2}	Regulator 2 Output. Sources up to 150mA continuous current. Bypass with a 1 μ F (<0.5 Ω typ ESR) capacitor to GND
2	GND	Ground. This pin also functions as heatsink. Solder to a large pad or the circuit-board ground plane to maximize thermal dissipation.
3	BYP	Reference Noise Bypass. Bypass with a low leakage 10nF ceramic capacitor for reduced noise at both outputs.
4	EN	Shutdown control input, active low. Tie this pin to or above 2.4V to enable the device. Tie this pin to or below 0.4V to turn off the device.
5	V _{IN}	Regulator Input. Supply voltage can range from [V _{OUT2} + 1V] to 5.5V. This input also supplies the on-chip reference. Bypass with a 1 μ F to GND.
6	V _{OUT1}	Regulator 1 Output. Sources up to 150mA continuous current. Bypass with a 1 μ F (<0.5 Ω typ ESR) capacitor to GND.

SP6265,G,H,J,K TSOT-26 Package without Bypass

Pin Number	Pin Name	Description
1	V _{OUT2}	Regulator 2 Output. Sources up to 150mA continuous current. Bypass with a 1 μ F (<0.5 Ω typ ESR) capacitor to GND
2	GND	Ground. This pin also functions as heatsink. Solder to a large pad or the circuit-board ground plane to maximize thermal dissipation.
3	EN1	Shutdown 1 control input, active low. Tie this pin to or above 2.4V to enable the device. Tie this pin to or below 0.4V to turn off the device.
4	EN2	Shutdown 2 control input, active low. Tie this pin to or above 2.4V to enable the device. Tie this pin to or below 0.4V to turn off the device.
5	V _{IN}	Regulator Input. Supply voltage can range from [V _{OUT2} + 1V] to 5.5V. This input also supplies the on-chip reference. Bypass with a 1 μ F to GND.
6	V _{OUT1}	Regulator 1 Output. Sources up to 150mA continuous current. Bypass with a 1 μ F (<0.5 Ω typ ESR) capacitor to GND.

SP6265,L,M DFN Package without Bypass

Pin Number	Pin Name	Description
1	V _{IN}	Regulator Input. Supply voltage can range from [V _{OUT2} + 1V] to 5.5V. This input also supplies the on-chip reference. Bypass with a 1 μ F to GND.
2	EN1	Shutdown 1 control input, active low. Tie this pin to or above 2.4V to enable the device. Tie this pin to or below 0.4V to turn off the device.
3	EN2	Shutdown 2 control input, active low. Tie this pin to or above 2.4V to enable the device. Tie this pin to or below 0.4V to turn off the device.
4	NC	Not Connected
5	GND	Ground. This pin also functions as heatsink. Solder to a large pad or the circuit-board ground plane to maximize thermal dissipation.
6	NC	Not Connected
	V _{OUT2}	Regulator 2 Output. Sources up to 150mA continuous current. Bypass with a 1 μ F (<0.5 Ω typ ESR) capacitor to GND.
6	V _{OUT1}	Regulator 1 Output. Sources up to 150mA continuous current. Bypass with a 1 μ F (<0.5 Ω typ ESR) capacitor to GND.

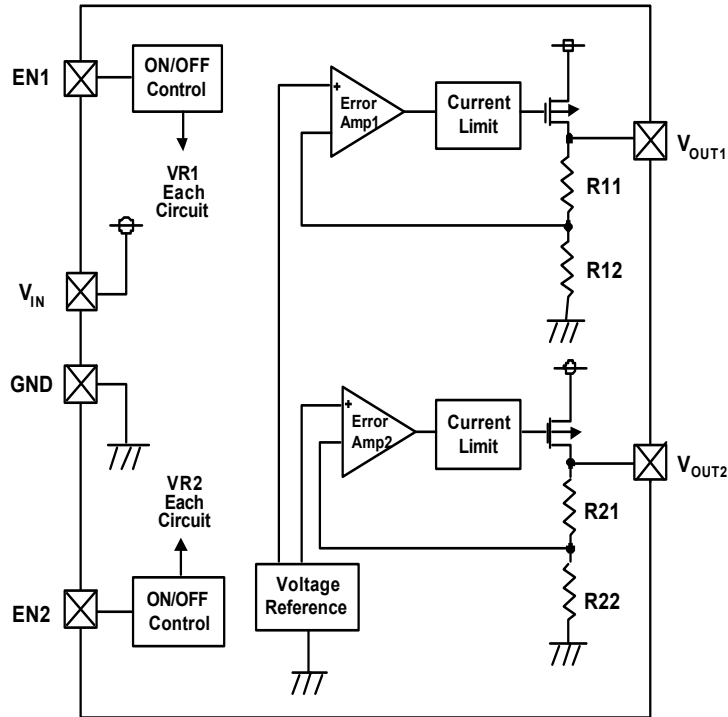

PINOUTS

TSOT-26
Top View

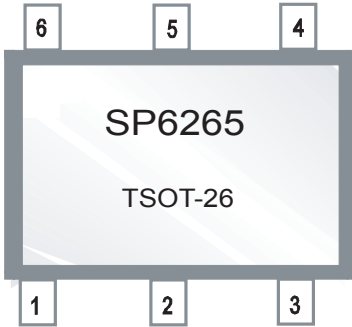

- SP6265AEK1
SP6265BEK1
1. V_{OUT2}
 2. GND
 3. BYP
 4. EN
 5. V_{IN}
 6. V_{OUT1}

*Die Attach:
Conductive Epoxy

TSOT-26
Top View



- SP6265FEK1
SP6265GEK1
SP6265HEK1
SP6265JEK1
SP6265KEK1

1. V_{OUT2}
2. GND
3. BYP
4. EN
5. V_{IN}
6. V_{OUT1}

*Die Attach:
Conductive Epoxy

DFN-8
(3mmx3mmx0.75mm)
Top View

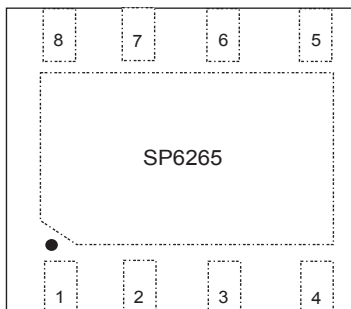

- SP6265LER6
SP6265MER6

1. V_{IN}
2. EN1
3. EN2
4. NC
5. GND
6. NC
7. V_{OUT2}
8. V_{OUT1}

*Die Attach:
Conductive Epoxy

The SP6265 is a low-dropout, low quiescent-current linear regulator designed primarily for battery-powered applications. These parts are available with preset output voltage ranging from 1.8V to 3.3V, and the parts can supply loads up to 150mA.

Shutdown

SP6265A & SP6265B

The SP6265A and SP6265B have a single shutdown control input (EN). Drive EN low to shutdown both outputs, reducing supply current to 0.3 μ A. Connect EN to a logic-high, or IN, for normal operation.

SP6265F-SP6265M

The SP6265F-SP6265M have independent shutdown control inputs (EN1 and EN2). Drive EN1 low to shutdown V_{OUT1} . Drive EN2 low to shutdown V_{OUT2} . Drive both EN1 and EN2 to shut down the entire chip, reducing supply current to 0.3 μ A. Connect both EN1 and EN2 to a logic-high, or IN, for normal operation.

Internal P-Channel Pass Transistor

The SP6265 features two 1 Ω P-Channel MOSFET pass transistors. A P-Channel MOSFET provides several advantages over similar designs using PNP pass transistors, including longer battery life. It requires no base drive, which reduces quiescent current significantly. The SP6265 only consumes 70 μ A of quiescent current whether in dropout, light-load, or heavy load applications.

Current Limit

The SP6265 contains two independent current limiters, one for each regulator, which monitor and control the pass transistor's gate voltage, limiting the guaranteed maximum output current to 180mA minimum. The output can be shorted to ground for an indefinite time without damaging the part.

Thermal-Overload Protection

Thermal-Overload protection limits total power dissipation in the SP6265. When the junction temperature exceeds $T_j = 150^\circ\text{C}$, the thermal sensor signals the shutdown logic, turning off the pass transistor and allowing the IC to cool.

Capacitor Selection and Regulator Stability

Use a 1 μ F capacitor in the outputs. Larger input capacitor values and lower ESRs provide better supply noise rejection and line transient response.

PSRR and Operation from sources other than Batteries

The SP6265 is designed to deliver low dropout voltages and low quiescent current in battery powered systems. Power-supply rejection is 54dB at low frequencies. (see the PSRR vs. Frequency graph)

Quiescent Current vs Input Voltage

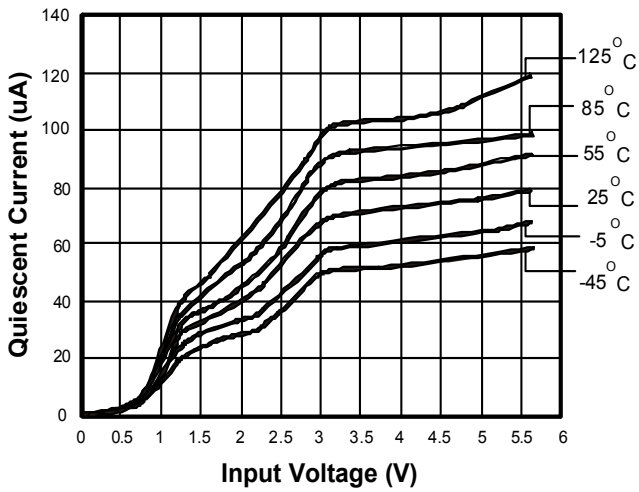

Dropout Voltage vs Load Current

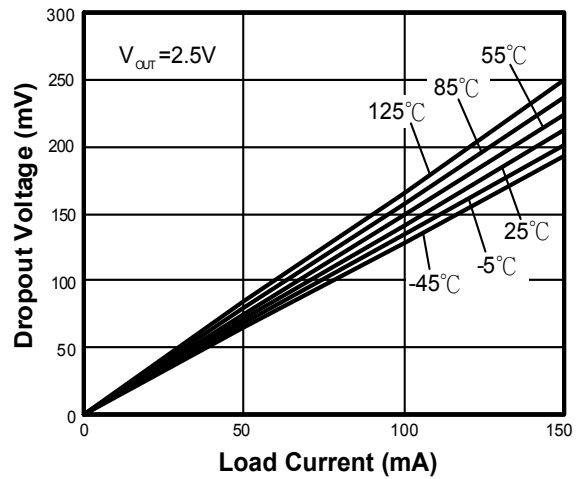

Supply Current vs. Load current

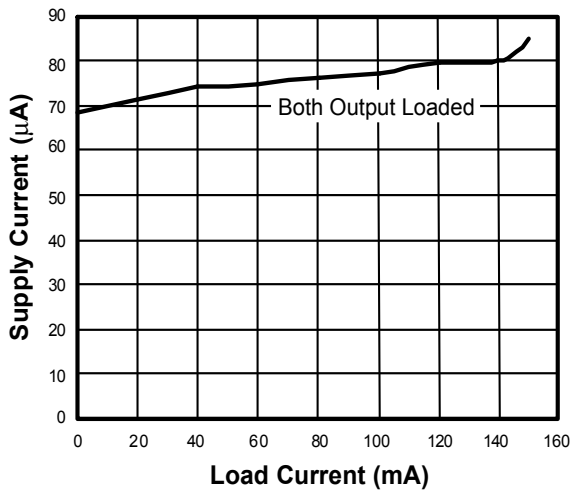

Dropout Voltage vs Output Voltage

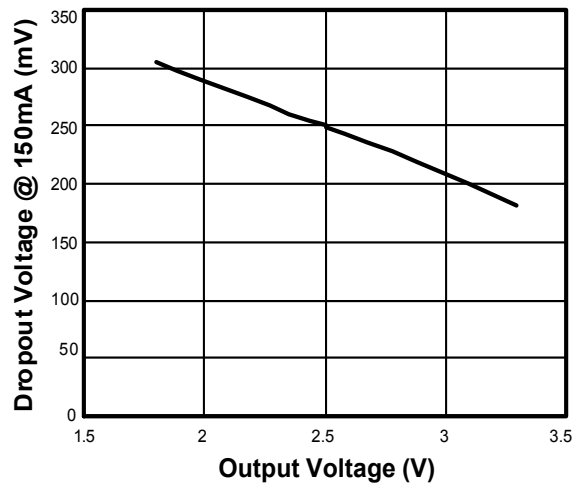

Quiescent Current vs Temperature

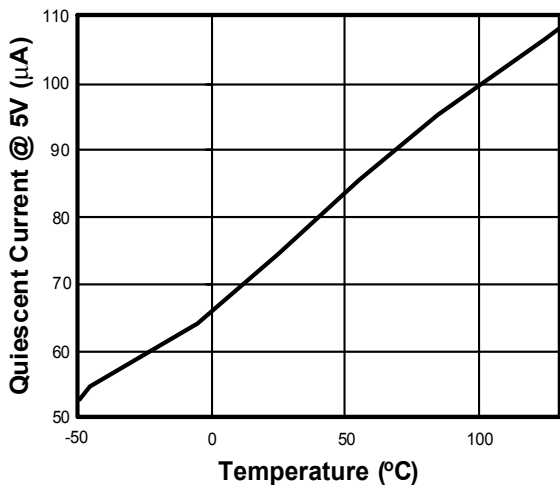

Output Voltage vs Temperature

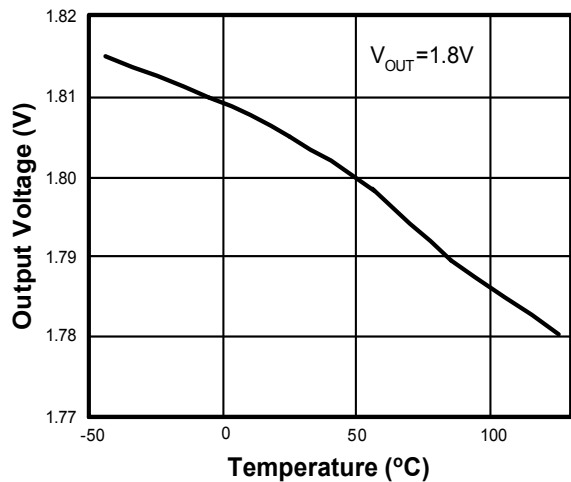

PSRR vs. Frequency

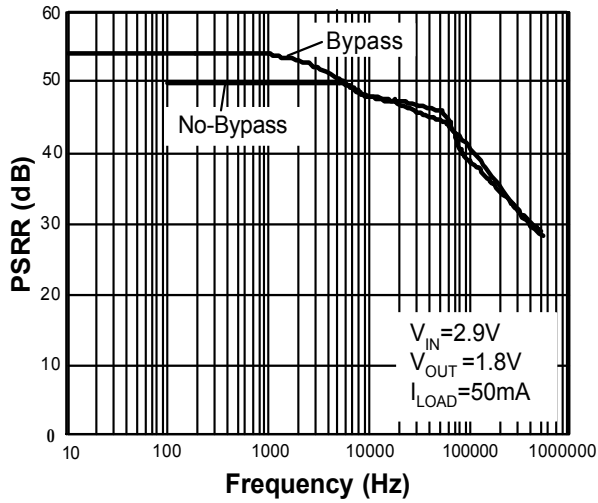

Line Transient

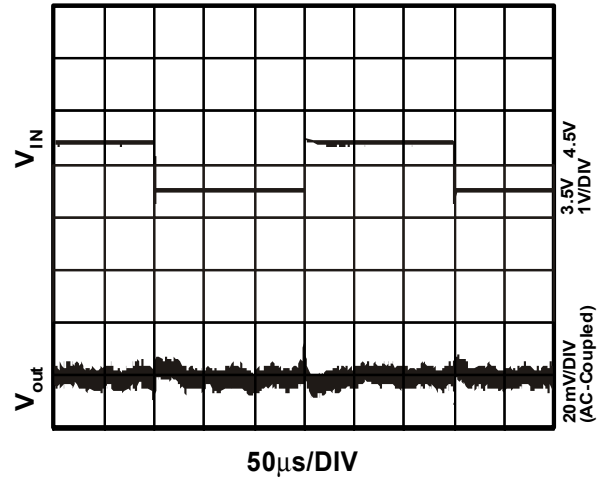

Channel-to-Channel Isolation vs Frequency

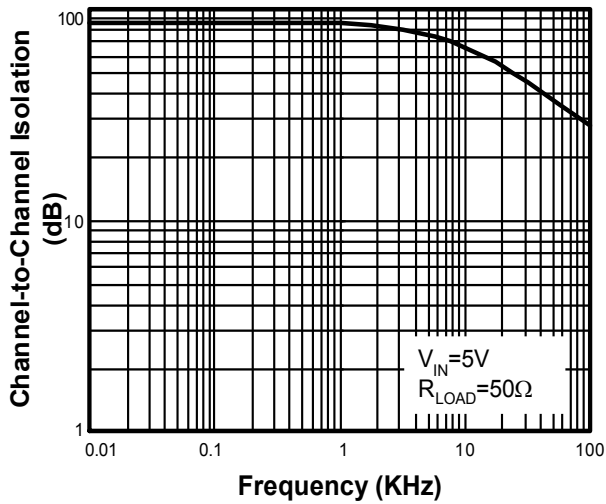

Load Transient

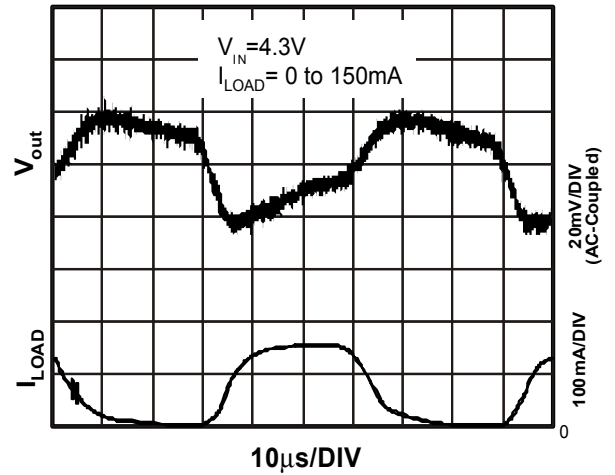

Output Noise Spectral Density

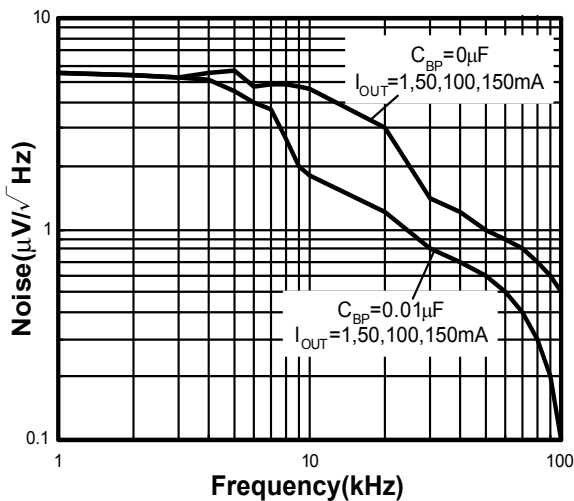

Load Transient Near Dropout

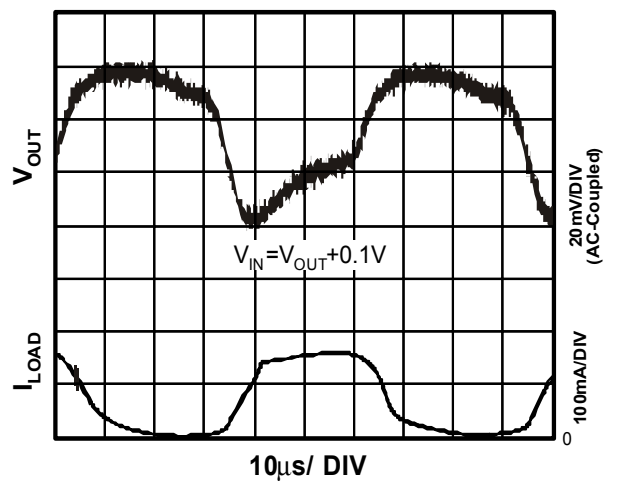

Shutdown Response

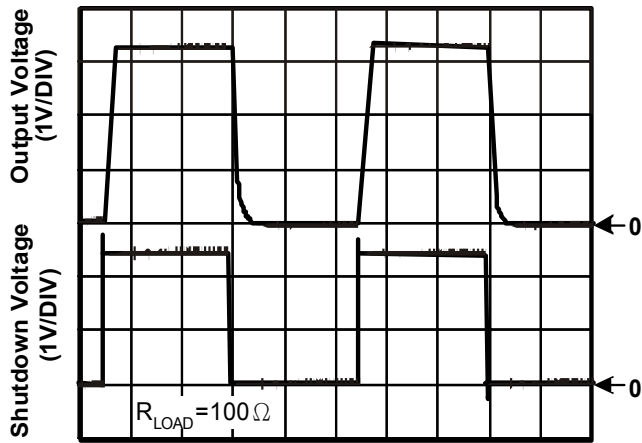

PACKAGE: 6 PIN TSOT

• Package Dimensions

TSOT-26

Side View

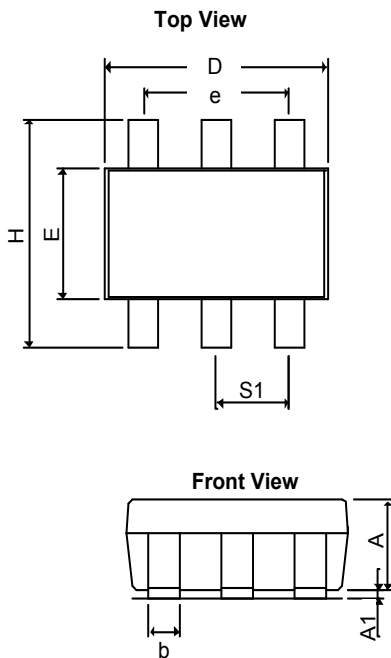

SYMBOLS	MILLIMETERS		INCHES	
	MIN	MAX	MIN	MAX
A+A ₁	0.90	1.25	0.0354	0.0492
b	0.30	0.50	0.0118	0.0197
c	0.09	0.25	0.0035	0.0098
D	2.70	3.10	0.1063	0.1220
E	1.40	1.80	0.0551	0.0709
e	1.90 BSC		0.07480 BSC	
H	2.40	3.00	0.09449	0.11811
L	0.35BSC		0.0138BSC	
θ1	0°	10°	0°	10°
S ₁	0.95BSC		0.0374BSC	

■ Package Dimension

DFN-8 (3mmx3mmx0.75mm)

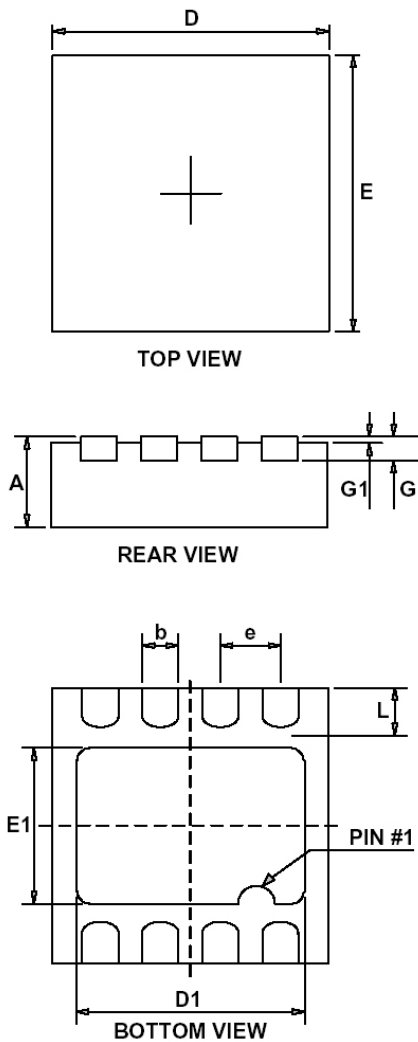

SYMBOLS	MILLIMETERS		INCHES	
	MIN	MAX	MIN	MAX
A	0.700	0.800	0.028	0.031
D	2.900	3.100	0.114	0.122
E	2.900	3.100	0.114	0.122
e	0.600	0.700	0.024	0.028
D1	2.200	2.400	0.087	0.094
E1	1.400	1.600	0.055	0.063
b	0.200	0.320	0.008	0.013
L	0.375	0.575	0.015	0.023
G	0.153	0.253	0.0060	0.010
G1	0.000	0.050	0.0000	0.002

Part Number	Voltage	Pin3/ Pin4 Trait	Voltage Accuracy	Operating Temperature Range	Package	Marking*	Packing Quantity
SP6265AEK1-L/TR	V1=1.8V V2=2.5V	Bypass/ Enable	1.5%	-40°C to +85°C	TSOT-26	X9WW	3,000 Tape & Reel
SP6265BEK1-L/TR	V1=1.8V V2=2.8V	Bypass/ Enable	1.5%	-40°C to +85°C	TSOT-26	Y9WW	3,000 Tape & Reel
SP6265FEK1-L/TR	V1=1.8V V2=2.5V	Dual Enable	1.5%	-40°C to +85°C	TSOT-26	DAWW	3,000 Tape & Reel
SP6265GEK1-L/TR	V1=1.8V V2=2.8V	Dual Enable	1.5%	-40°C to +85°C	TSOT-26	EAWW	3,000 Tape & Reel
SP6265HEK1-L/TR	V1=1.8V V2=3.3V	Dual Enable	1.5%	-40°C to +85°C	TSOT-26	FAWW	3,000 Tape & Reel
SP6265JEK1-L/TR	V1=2.85V V2=2.85V	Dual Enable	1.5%	-40°C to +85°C	TSOT-26	GAWW	3,000 Tape & Reel
SP6265KEK1-L/TR	V1=3.0V V2=3.0V	Dual Enable	1.5%	-40°C to +85°C	TSOT-26	HAWW	3,000 Tape & Reel
SP6265LER6-L/TR	V1=1.8V V2=2.5V	Dual Enable	1.5%	-40°C to +85°C	DFN8	6265LEWWX	1,000 Tape & Reel
SP6265MER6-L/TR	V1=1.8V V2=2.8V	Dual Enable	1.5%	-40°C to +85°C	DFN8	6265MEWWX	1,000 Tape & Reel

*Note: "WW" = Product Work Week, "X" = 1st Alpha of Lot Number



Sipex Corporation
 Headquarters and
 Sales Office
 233 South Hillview Drive
 Milpitas, CA 95035
 TEL: (408) 934-7500
 FAX: (408) 935-7600

Sipex Corporation reserves the right to make changes to any products described herein. Sipex does not assume any liability arising out of the application or use of any product or circuit described herein; neither does it convey any license under its patent rights nor the rights of others.

Looking for pricing, stock, or lifecycle information?

Click below to explore more details on WIN SOURCE:

 [View SP6265JEK1-L/TR on WIN SOURCE](#)

 [MaxLinear Inc Information](#)

Optimize Your Supply Chain with WIN SOURCE Solutions

-  Global Sourcing Solution
-  Obsolete Management
-  Cost Control Management
-  Shortage Management
-  Alternative Solution
-  Excess Inventory Management