



# CPH6354

## Power MOSFET -60V, 100mΩ, -4A, Single P-Channel

ON Semiconductor®

www.onsemi.com

### Features

- ON-resistance  $R_{DS(on)1}=77m\Omega$ (typ.)
- 4V Drive
- ESD Diode - Protected Gate
- Pb-Free, Halogen Free and RoHS Compliance

### Specifications

#### Absolute Maximum Ratings at $T_a=25^\circ C$

Parameter	Symbol	Conditions	Value	Unit
Drain-to-Source Voltage	$V_{DSS}$		-60	V
Gate-to-Source Voltage	$V_{GSS}$		$\pm 20$	V
Drain Current (DC)	$I_D$		-4	A
Drain Current (Pulse)	$I_{DP}$	$PW \leq 10\mu s$ , duty cycle $\leq 1\%$	-16	A
Power Dissipation	$P_D$	When mounted on ceramic substrate (1500mm <sup>2</sup> ×0.8mm)	1.6	W
Junction Temperature	$T_j$		150	°C
Storage Temperature	$T_{stg}$		-55 to +150	°C

Stresses exceeding those listed in the Maximum Ratings table may damage the device. If any of these limits are exceeded, device functionality should not be assumed, damage may occur and reliability may be affected.

### Thermal Resistance Ratings

Parameter	Symbol	Value	Unit
Junction to Ambient When mounted on ceramic substrate (1500mm <sup>2</sup> ×0.8mm)	$R_{\theta JA}$	78.1	°C/W

### Package Dimensions

unit : mm (typ)

7018A-003

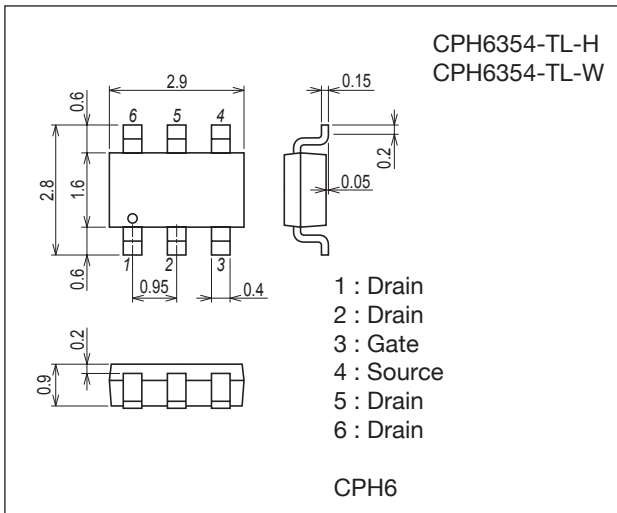

### Product & Package Information

- Package : CPH6
- JEITA, JEDEC : SC-74, SOT-26, SOT-457
- Minimum Packing Quantity : 3,000 pcs./reel

### Packing Type: TL

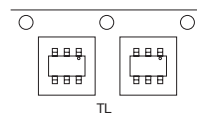

### Marking

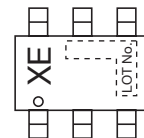

### Electrical Connection

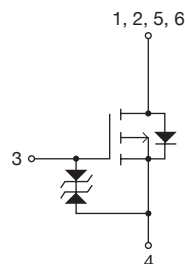

### ORDERING INFORMATION

See detailed ordering and shipping information on page 2 of this data sheet.

# CPH6354

## Electrical Characteristics at Ta=25°C

Parameter	Symbol	Conditions	Value			Unit
			min	typ	max	
Drain-to-Source Breakdown Voltage	$V_{(BR)DSS}$	$I_D = -1mA, V_{GS} = 0V$	-60			V
Zero-Gate Voltage Drain Current	$I_{DSS}$	$V_{DS} = -60V, V_{GS} = 0V$			-1	$\mu A$
Gate-to-Source Leakage Current	$I_{GSS}$	$V_{GS} = \pm 16V, V_{DS} = 0V$			$\pm 10$	$\mu A$
Gate Threshold Voltage	$V_{GS(th)}$	$V_{DS} = -10V, I_D = -1mA$	-1.2		-2.6	V
Forward Transconductance	$g_{FS}$	$V_{DS} = -10V, I_D = -2A$		4.8		S
Static Drain-to-Source On-State Resistance	$R_{DS(on)1}$	$I_D = -2A, V_{GS} = -10V$		77	100	$m\Omega$
	$R_{DS(on)2}$	$I_D = -1A, V_{GS} = -4.5V$		96	135	$m\Omega$
	$R_{DS(on)3}$	$I_D = -1A, V_{GS} = -4V$		103	145	$m\Omega$
Input Capacitance	$C_{iss}$			600		pF
Output Capacitance	$C_{oss}$	$V_{DS} = -20V, f = 1MHz$		60		pF
Reverse Transfer Capacitance	$C_{rss}$			50		pF
Turn-ON Delay Time	$t_{d(on)}$	See specified Test Circuit.		5.8		ns
Rise Time	$t_r$			12		ns
Turn-OFF Delay Time	$t_{d(off)}$			78		ns
Fall Time	$t_f$			40		ns
Total Gate Charge	$Q_g$				14	
Gate-to-Source Charge	$Q_{gs}$	$V_{DS} = -30V, V_{GS} = -10V, I_D = -4A$		1.6		nC
Gate-to-Drain "Miller" Charge	$Q_{gd}$			3.4		nC
Forward Diode Voltage	$V_{SD}$	$I_S = -4A, V_{GS} = 0V$		-0.84	-1.2	V

Product parametric performance is indicated in the Electrical Characteristics for the listed test conditions, unless otherwise noted. Product performance may not be indicated by the Electrical Characteristics if operated under different conditions.

## Switching Time Test Circuit

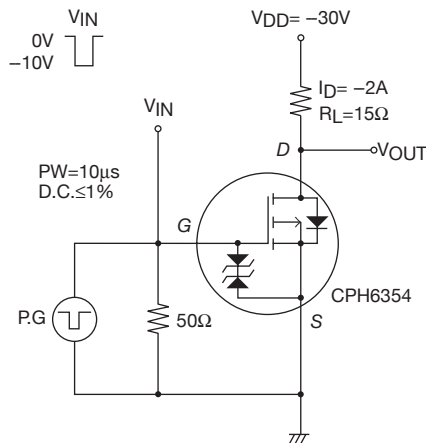

## ORDERING INFORMATION

Device	Package	Shipping	memo
CPH6354-TL-H	CPH6	3,000pcs./reel	Pb-Free and Halogen Free
CPH6354-TL-W			

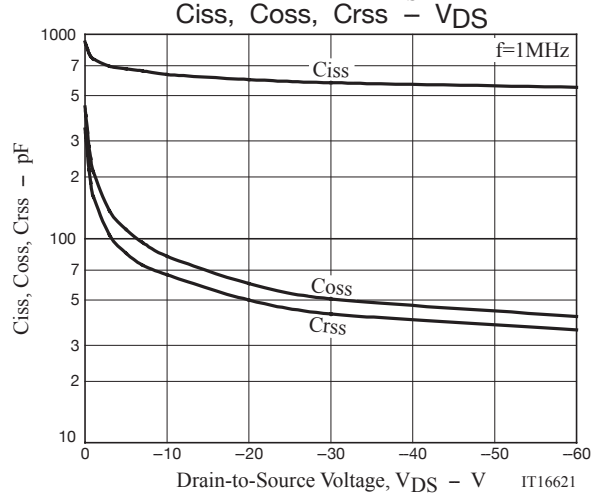
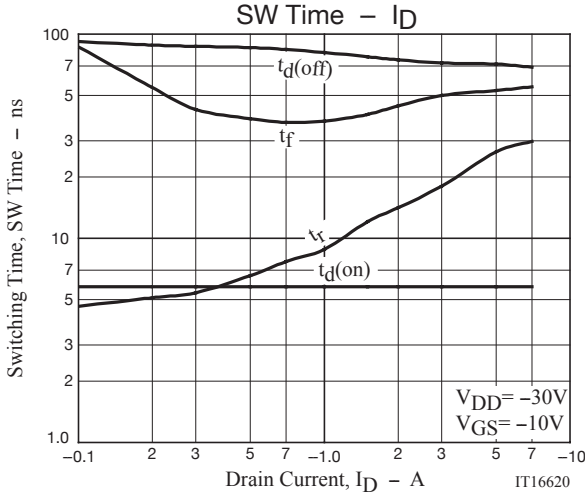
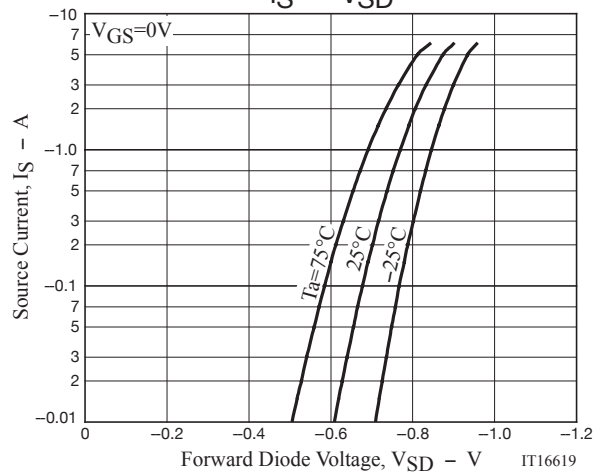
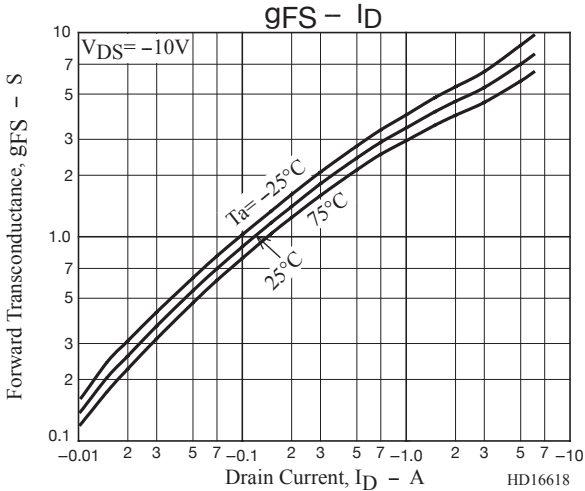
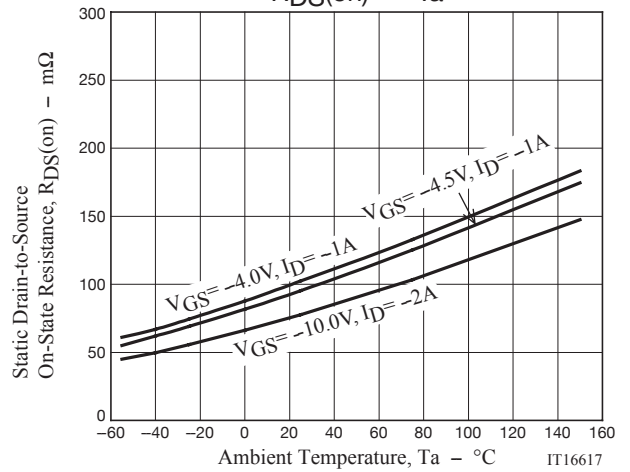
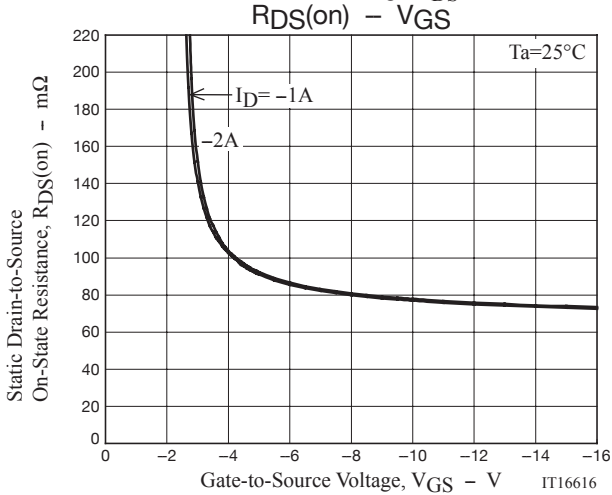
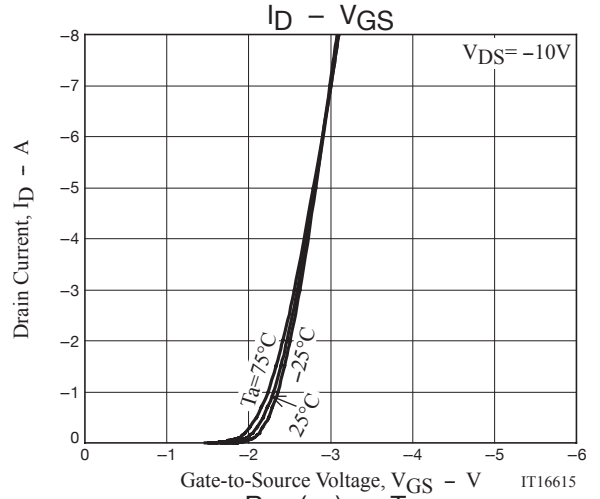
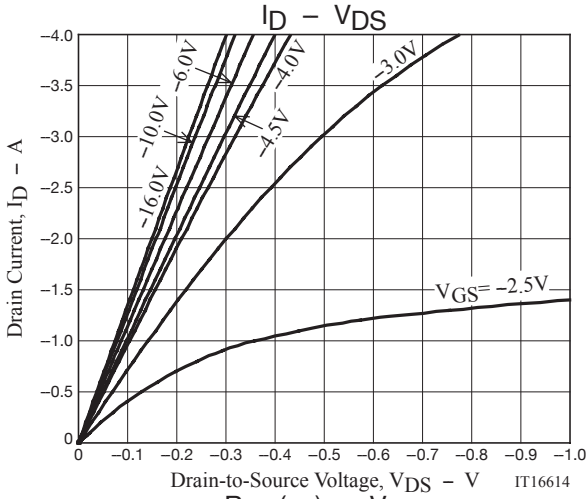

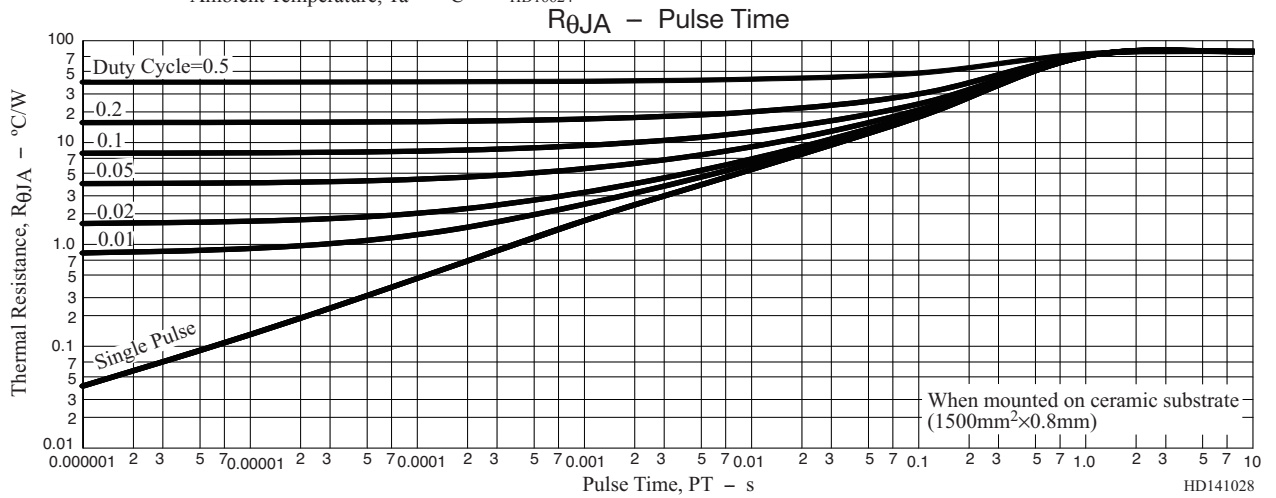
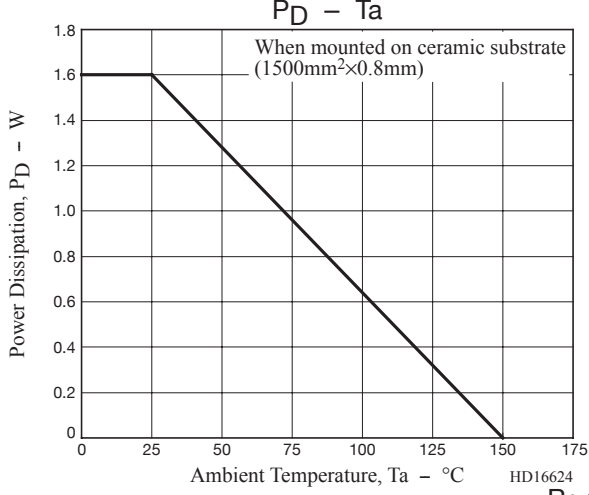
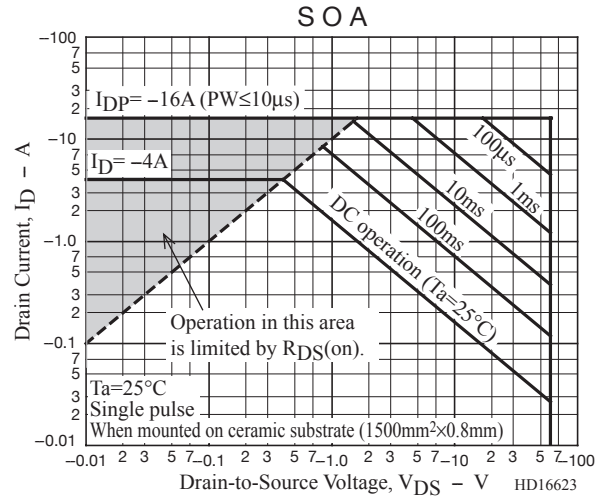
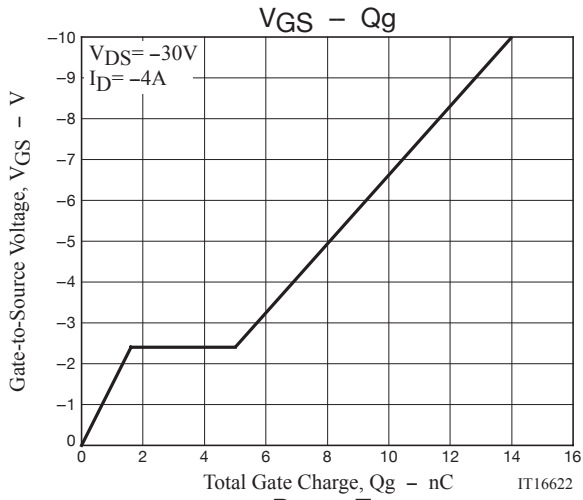





## Looking for pricing, stock, or lifecycle information?

Click below to explore more details on WIN SOURCE:

-  [View CPH6354-TL-H on WIN SOURCE](#)
-  [ON Semiconductor](#) Information

## Optimize Your Supply Chain with WIN SOURCE Solutions

-  Global Sourcing Solution
-  Obsolete Management
-  Cost Control Management
-  Shortage Management
-  Alternative Solution
-  Excess Inventory Management