



**THE DATASHEET OF
DS1050-3-002**



ARTESYN DS1050

Distributed Power Bulk Front-End



Advanced Energy's Artesyn DS1050 series bulk front end AC-DC power supply accepts a wide range 90–264 Vac input and provides a main 12 V output plus a 3.3 V or 5 V standby output. Rated at 1,050 watts it is an 80 Plus Gold supply with a high half-load efficiency of 92%. Housed in an industry standard 1U x 2U rack-mounting package, the power supply is ideal for space-constrained applications. This series comes in two airflow versions – dc-connector to ac-connector and vice versa.

DATA SHEET

Total Output Power:

1050 Watts
+3.3 or 5.0 Vdc Standby Output

Wide Range Input Voltage:

90 - 264 Vac

SPECIAL FEATURES

- Active power factor correction
- EN61000-3-2 harmonic compliance
- Inrush control
- 1U X 2U form factor
- 19.0 W/in³
- +12 Vdc output
- Available in +3.3 V and +5.0 V standby output versions
- No minimum load required
- Hot plug operation
- N + 1 redundant
- Internal OR'ing fets
- Active current sharing (10 - 100% load)
- Built-in cooling fan (40 mm x 28 mm)
- I²C communication interface bus
- PMBus compliant
- EEPROM for FRU data
- Amber/green bi-color LED status
- Internal fan speed control
- Fan fail tach output signal
- Full digital control
- Two-year warranty

SAFETY

- UL/cUL 60950 (UL Recognized)
- NEMKO+ CB report EN60950
- EN60950
- CE mark
- China CCC



ELECTRICAL SPECIFICATIONS

Input	
Input range	180 - 264 (1050 W) 90 - 264 (1050 W)
Frequency	47 - 63 Hz, single phase AC
Inrush current	40 Apk maximum inrush current
Efficiency	> 92% typical at high line 50% load (Climate Saver Gold)
Conducted EMI	FCC Subpart J EN55022 Class B
Radiated EMI	FCC Subpart J EN55022 Class B
Power factor	0.99 typical
Leakage current	1.40 mA @ 240 Vac
Hold up time	12 ms minimum
Output	
Main DC voltage	+12 V @ 87 A
Standby	+3.3 Vsb @ 4 A (5 V @ 2.5 A available)*
Adjustment range	± 5% on +12V only using I ² C
Regulation	+12 Vdc; +5%/-5% +3.3 Vsb; +5%/-5%
Overcurrent	+12 Vdc; latches off if overcurrent lasts over 1 second, otherwise it is auto recovery (See Table 1 next page) +3.3 Vsb, 6 A max (hiccup mode)
Overvoltage	+12 Vdc; 13.2 - 14.4 Vdc +3.3 Vsb; 3.76 - 4.30 Vdc
Undervoltage	+12 Vdc; 9 - 10.8 V (latch off)
Turn-on delay	2 second max, 5 - 50 mS, monotonic rise
Main output rise time	5 - 50 mS, monotonic rise

*20 W standby available with derated efficiency

LOGIC CONTROL

PS_SEATED (A4)	TTL logic LOW if power supply is seated into system connector. This is a short pin. A logic HIGH if the PSU is removed
PWR_GOOD (C3)	Active TTL high when output is within regulation limits.
AC_OK (B1)	A low logic level if the input voltage is within allowable limits. A TTL logic HIGH level, and a 5mS early warning signal before 12.0 V DC output loss of regulation.
PS_INHIBIT/PS_KILL (B4)	This signal is connected to a short pin on the PSU When left open power supply operation will be inhibited. When the power supply is inserted into the system, this pin will be pull low by the system and turn the power supply on only after all other power supply pins have seated.
PS_ON (A1)	The output will be enabled when this signal is pulled low, below 0.8 V outputs disabled when pin is driven high or left open.

ENVIRONMENTAL SPECIFICATIONS

Operating temperature	-10 °C to 50 °C ; 50% power derating at 70 °C
Storage temperature	-40 °C to +85 °C
Altitude, operating	10,000 ft
Electromagnetic susceptibility/Input transients	-EN61000-3-2, -3-3 -EN61000-4-2, 4.3, 4-4, -4-5, 4-11 -EN55024:1998
RoHS & lead-free compliant	No tantalum caps.
Humidity	20 to 90% RH, non-condensing
Shock and vibration specifications	Standard operating/non-operating random shock/vibration
MTBF (Demonstrated)	500K Hrs at full load, 40 °C

ORDERING INFORMATION

Model Number	Nominal Output Voltage Set Point	Set Point Tolerance	Total Regulation	Minimum Current	Maximum Current	Output Ripple P/P	Over Current	Standby**	Air Flow
DS1050-3	12.0 Vdc	±0.2%	±5%	0 A	87 A	120 mV	102.7 A - 128.4 A	3.3 V @ 4 A	STD
DS1050-3-001	12.0 Vdc	±0.2%	±5%	0 A	87 A	120 mV	102.7 A - 128.4 A	3.3 V @ 4 A	REV
DS1050-3-002	12.0 Vdc	±0.2%	±5%	0 A	87 A	120 mV	102.7 A - 128.4 A	5.0 V @ 2.5 A	STD
DS1050-3-003	12.0 Vdc	±0.2%	±5%	0 A	87 A	120 mV	102.7 A - 128.4 A	5.0 V @ 2.5 A	REV

*Overcurrent latches off if overcurrent lasts over 1 seconds, otherwise it is auto recovery.

** 3.3 V standby can operate at 6 A, but overall unit efficiency will fall slightly below Gold Standard.

MECHANICAL DRAWING

Condition	LED Status
Standby - ON; Main output - OFF; AC PRESENT	Blinking green
Standby - ON; Main output - ON	Solid green
Main output OCP, UVP, OVP	Blinking Amber
FAN_FAULT; OTP; Standby OCP/UVP	Amber

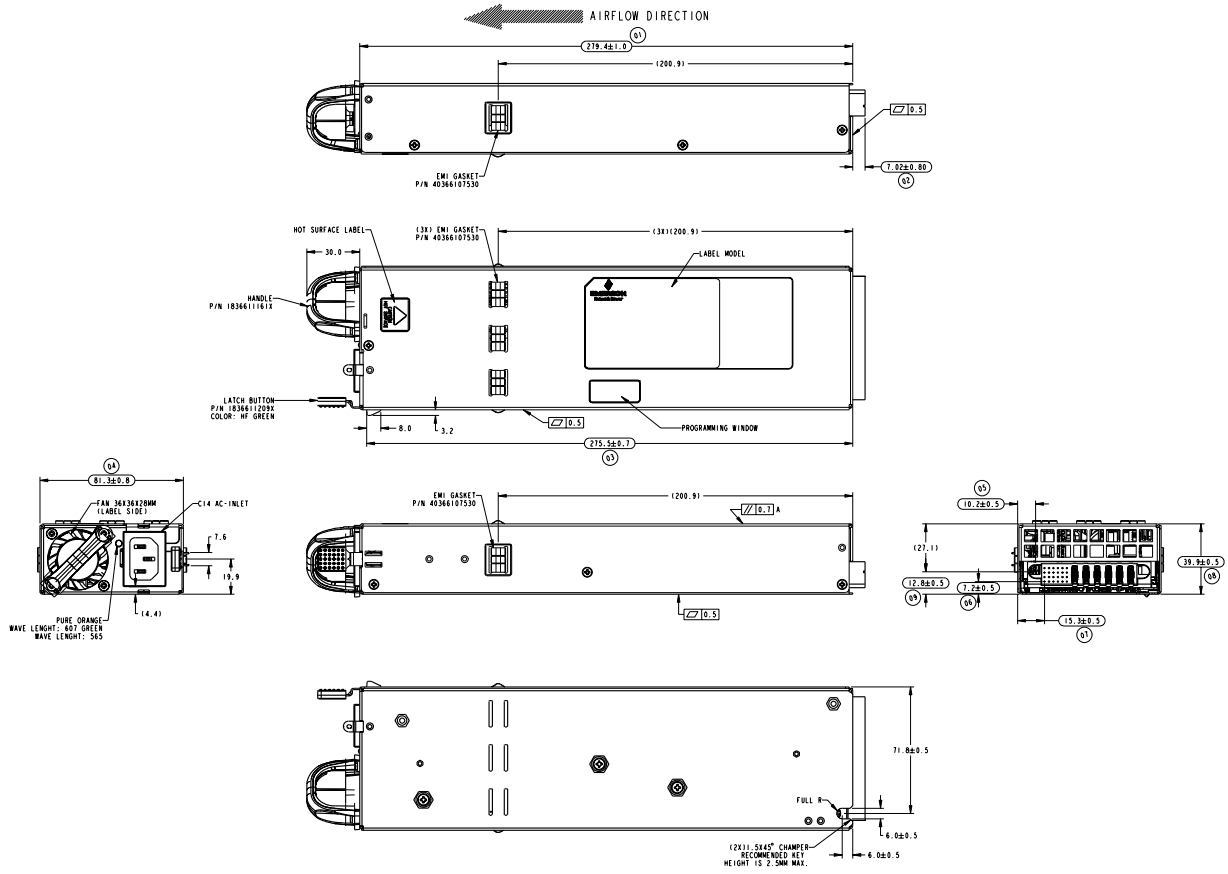

DC OUTPUT CONNECTOR PINOUT ASSIGNMENT

Male connector as viewed from the rear of the supply:

D1	D2	D3	D4	D5	D6	PB1	PB2	PB3	PB4	PB5	PB6
C1	C2	C3	C4	C5	C6						
B1	B2	B3	B4	B5	B6						
A1	A2	A3	A4	A5	A6						

P1 - POWER SUPPLY SIDE

1	FCI Power Blade 51721 series 51721-10002406AA
2	Molex Power Connector SD-87667 series 87667-7002

MATING CONNECTOR (SYSTEM SIDE)

1	FCI Power Blade 51741-10002406CC Strait Pins
2	FCI Power Blade 51761-10002406AA Right Angle

PIN ASSIGNMENTS

Pin	Signal Name
PB 1	Main output return
PB 2	Main output return
PB 3	Main output return
PB 4	+ Main output
PB 5	+ Main output
PB 6	+ Main output
A1	PS_ON
A2	Main output remote sense return
A3	Spare
A4	PS_SEATED (Power Supply Seated)
A5	STANDBY
A6	STANDBY RETURN
B1	AC_OK (AC Input Present)
B2	Main output remote sense
B3	Main output current share
B4	PS_INHIBIT/PS_Kill
B5	STANDBY
B6	STANDBY RETURN
C1	SDA (I ² C Data Signal)
C2	SCL (I ² C Clock Signal)*
C3	POWER GOOD
C4	Spare
C5	STANDBY
C6	STANDBY RETURN
D1	A0 (I ² C Address BIT 0 Signal)
D2	A1 (I ² C Address BIT 1 Signal)
D3	S_INT (Alarm)
D4	STANDBY RMT SENSE
D5	STANDBY
D6	STANDBY RETURN

*Supports I²C standard mode (100 kHz) only



For international contact information,
visit advancedenergy.com.

powersales@aei.com (Sales Support)
productsupport.ep@aei.com (Technical Support)
+1 888 412 7832

ABOUT ADVANCED ENERGY

Advanced Energy (AE) has devoted more than three decades to perfecting power for its global customers. AE designs and manufactures highly engineered, precision power conversion, measurement and control solutions for mission-critical applications and processes.



Our products enable customer innovation in complex applications for a wide range of industries including semiconductor equipment, industrial, manufacturing, telecommunications, data center computing, and medical. With deep applications know-how and responsive service and support across the globe, we build collaborative partnerships to meet rapid technological developments, propel growth for our customers, and innovate the future of power.

PRECISION | POWER | PERFORMANCE







Specifications are subject to change without notice. Not responsible for errors or omissions. ©2020 Advanced Energy Industries, Inc. All rights reserved. Advanced Energy®, AE® and Artesyn™ are U.S. trademarks of Advanced Energy Industries, Inc.

Looking for pricing, stock, or lifecycle information?

Click below to explore more details on WIN SOURCE:

-  [View DS1050-3-002 on WIN SOURCE](#)
-  [Artesyn Embedded Technologies Information](#)

Optimize Your Supply Chain with WIN SOURCE Solutions

-  Global Sourcing Solution
-  Obsolete Management
-  Cost Control Management
-  Shortage Management
-  Alternative Solution
-  Excess Inventory Management