



THE DATASHEET OF BUK9K25-40RAX





BUK9K25-40RA

Dual N-channel 40 V, 29 mOhm logic level MOSFET in LPAK56D using Repetitive Avalanche technology

2 December 2020

Product data sheet

1. General description

Dual, logic level N-channel MOSFET in an LPAK56D package, using Application Specific (ASFET) repetitive avalanche silicon technology. This product has been designed and qualified to AEC-Q101 for use in repetitive avalanche applications.

2. Features and benefits

- Fully automotive qualified to AEC-Q101 at 175 °C
- Repetitive Avalanche rated to 30 °C T_j rise:
 - Tested to 1 Bn avalanche events
- LPAK copper clip package technology:
 - High robustness and reliability
 - Gull wing leads for high manufacturability and AOI

3. Applications

- 12 V, 24 V and 48 V automotive systems
- Repetitive avalanche topologies
- Engine control
- Transmission control
- Actuator and auxiliary loads

4. Quick reference data

Table 1. Quick reference data

Symbol	Parameter	Conditions	Min	Typ	Max	Unit
V_{DS}	drain-source voltage	$25\text{ °C} \leq T_j \leq 175\text{ °C}$	-	-	40	V
I_D	drain current	$V_{GS} = 5\text{ V}$; $T_{mb} = 25\text{ °C}$; Fig. 2	-	-	18.2	A
P_{tot}	total power dissipation	$T_{mb} = 25\text{ °C}$; Fig. 1	-	-	32	W
Static characteristics FET1 and FET2						
R_{DSon}	drain-source on-state resistance	$V_{GS} = 5\text{ V}$; $I_D = 5\text{ A}$; $T_j = 25\text{ °C}$; Fig. 14	-	24	29	mΩ
Dynamic characteristics FET1 and FET2						
Q_{GD}	gate-drain charge	$I_D = 5\text{ A}$; $V_{DS} = 32\text{ V}$; $V_{GS} = 5\text{ V}$; $T_j = 25\text{ °C}$; Fig. 16 ; Fig. 17	-	2.4	-	nC

5. Pinning information

Table 2. Pinning information

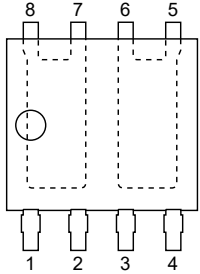
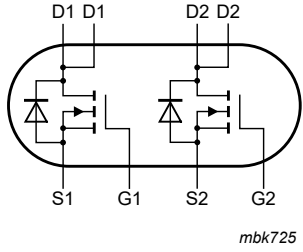
Pin	Symbol	Description	Simplified outline	Graphic symbol
1	S1	source1	 <p>LFAK56D; Dual LFAK (SOT1205)</p>	 <p>mbk725</p>
2	G1	gate1		
3	S2	source2		
4	G2	gate2		
5	D2	drain2		
6	D2	drain2		
7	D1	drain1		
8	D1	drain1		

6. Ordering information

Table 3. Ordering information

Type number	Package		
	Name	Description	Version
BUK9K25-40RA	LFAK56D; Dual LFAK	plastic, single ended surface mounted package (LFAK56D); 8 leads	SOT1205

7. Marking

Table 4. Marking codes

Type number	Marking code
BUK9K25-40RA	92540RA

8. Limiting values

Table 5. Limiting values

In accordance with the Absolute Maximum Rating System (IEC 60134).

Symbol	Parameter	Conditions	Min	Max	Unit	
V_{DS}	drain-source voltage	$25\text{ °C} \leq T_j \leq 175\text{ °C}$	-	40	V	
V_{DGR}	drain-gate voltage	$R_{GS} = 20\text{ k}\Omega$	-	40	V	
V_{GS}	gate-source voltage	Pulsed; $T_j \leq 175\text{ °C}$	[1] [2]	-15	15	V
		DC; $T_j \leq 175\text{ °C}$		-10	10	V
P_{tot}	total power dissipation	$T_{mb} = 25\text{ °C}$; Fig. 1	-	32	W	
I_D	drain current	$V_{GS} = 5\text{ V}$; $T_{mb} = 25\text{ °C}$; Fig. 2	-	18.2	A	
		$V_{GS} = 5\text{ V}$; $T_{mb} = 100\text{ °C}$; Fig. 2	-	16.6	A	
I_{DM}	peak drain current	pulsed; $t_p \leq 10\text{ }\mu\text{s}$; $T_{mb} = 25\text{ °C}$; Fig. 3	-	94	A	
T_{stg}	storage temperature		-55	175	°C	
T_j	junction temperature		-55	175	°C	
Source-drain diode FET1 and FET2						
I_S	source current	$T_{mb} = 25\text{ °C}$	-	18.2	A	
I_{SM}	peak source current	pulsed; $t_p \leq 10\text{ }\mu\text{s}$; $T_{mb} = 25\text{ °C}$	-	94	A	

Dual N-channel 40 V, 29 mOhm logic level MOSFET in LPAK56D using Repetitive Avalanche technology

Symbol	Parameter	Conditions	Min	Max	Unit	
Avalanche ruggedness						
$E_{DS(AL)R}$	repetitive drain-source avalanche energy	$I_D = 0.73 \text{ A}$; $V_{sup} \leq 40 \text{ V}$; $R_{GS} = 10 \text{ }\Omega$; $V_{GS} = 10 \text{ V}$; $T_{j(rise)} \leq 30 \text{ }^\circ\text{C}$; unclamped; Fig. 4; Fig. 5; Fig. 6	[3] [4] [5]	-	19	mJ
Avalanche ruggedness FET1 and FET2						
$E_{DS(AL)S}$	non-repetitive drain-source avalanche energy	$I_D = 18.2 \text{ A}$; $V_{sup} \leq 40 \text{ V}$; $V_{GS} = 10 \text{ V}$; $T_{j(init)} = 25 \text{ }^\circ\text{C}$; Fig. 7	[6] [7]	-	15	mJ

- [1] Accumulated Pulse duration up to 50 hours delivers zero defect ppm.
- [2] Significantly longer life times are achieved by lowering T_j and/or V_{GS} .
- [3] Repetitive avalanche rating is limited by maximum junction temperature of 175 °C and junction rise of 30 °C
- [4] Refer to Fig. 5 for the limiting number of avalanche events
- [5] Refer to Fig. 6 R_{dson} at $V_{gs}=5V$ will increase as a function of repetitive avalanche cycles
- [6] Refer to application note AN10273 for further information
- [7] Single-pulse avalanche rating limited by maximum junction temperature of 175 °C

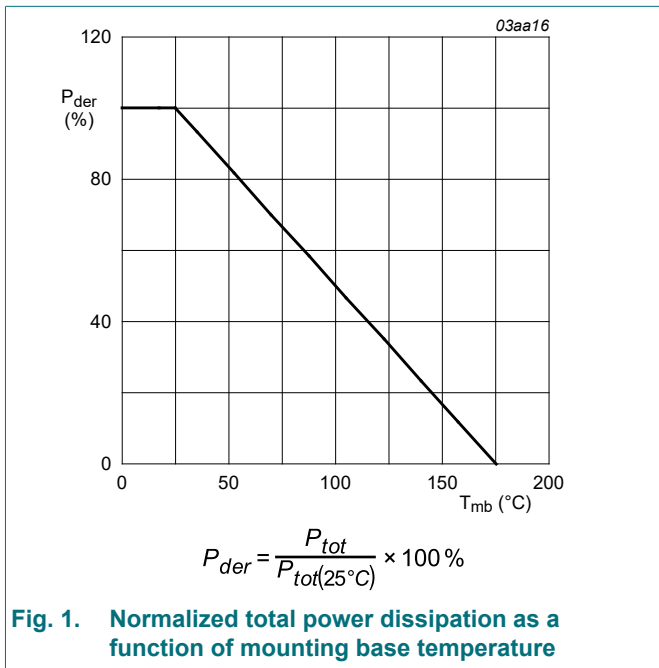

Fig. 1. Normalized total power dissipation as a function of mounting base temperature

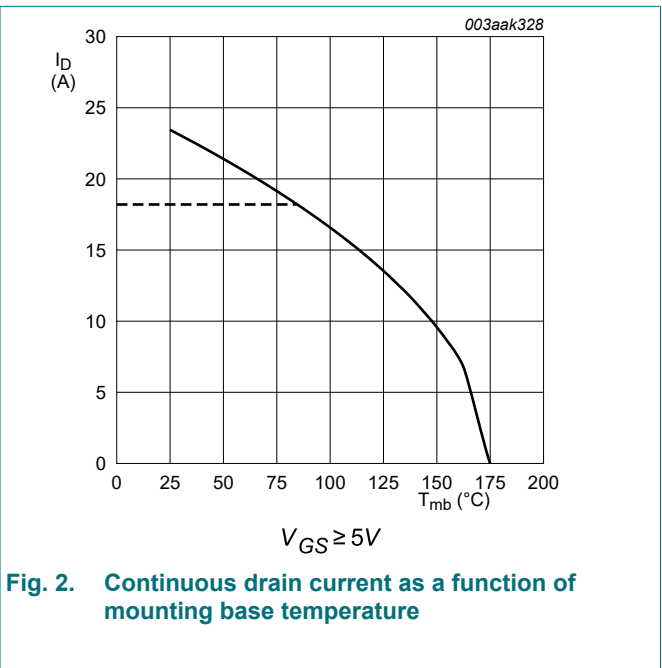

Fig. 2. Continuous drain current as a function of mounting base temperature

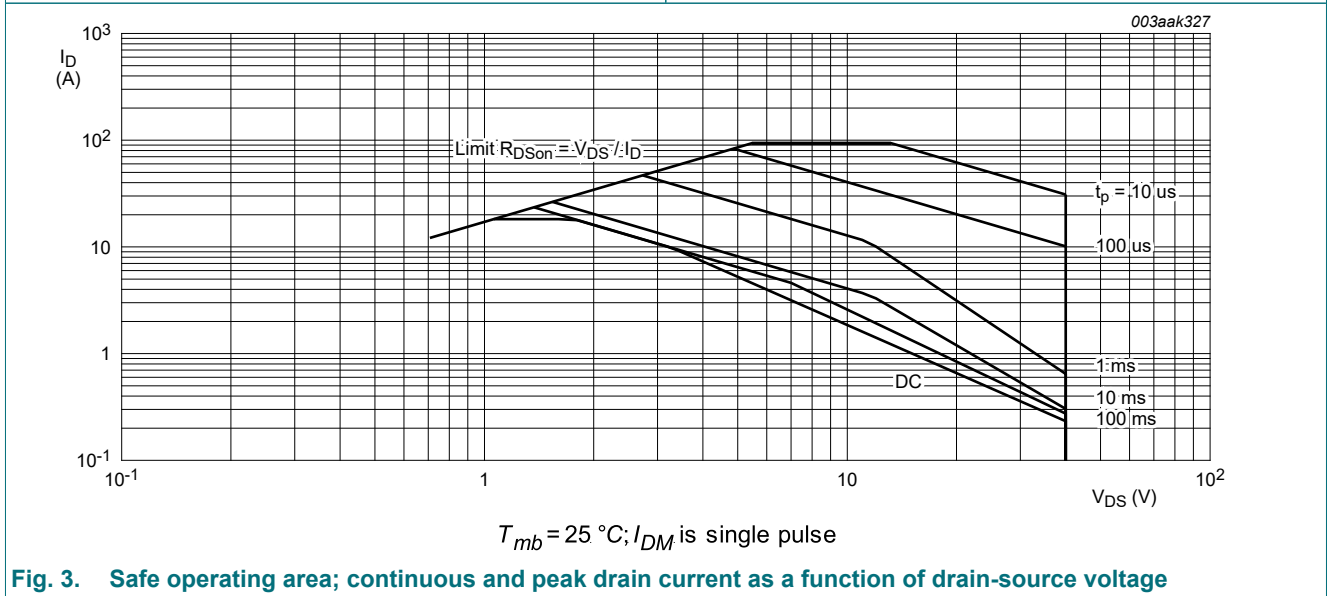
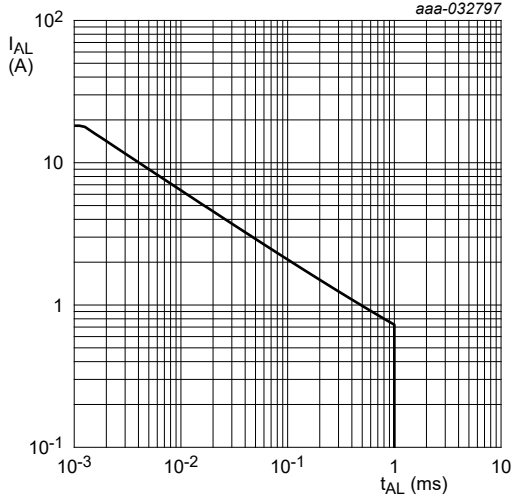

Fig. 3. Safe operating area; continuous and peak drain current as a function of drain-source voltage

Dual N-channel 40 V, 29 mOhm logic level MOSFET in LPAK56D using Repetitive Avalanche technology



T_j is limited to 175 °C and $T_{j(rise)}$ is limited to 30 °C

Fig. 4. Repetitive avalanche rating; avalanche current as a function of avalanche time

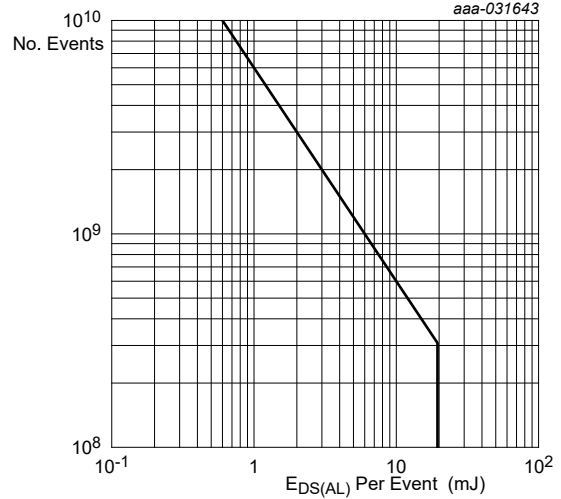

Fig. 5. Repetitive avalanche rating; maximum number of avalanche events as a function of avalanche energy

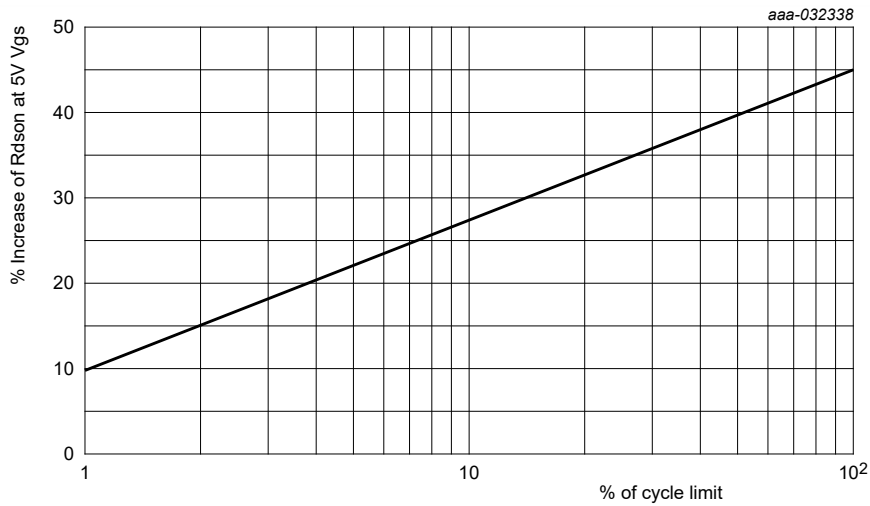
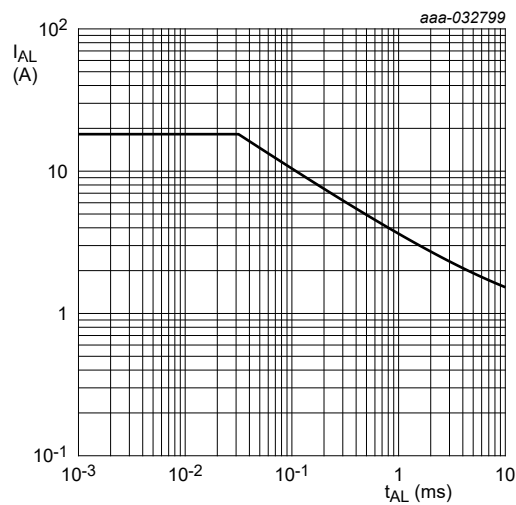

Fig. 6. Percentage $R_{DS(on)}$ at 5V increase as a function of avalanche cycles



$T_{j (init)} = 25$ °C

Fig. 7. Single pulse avalanche rating; avalanche current as a function of avalanche time

9. Thermal characteristics

Table 6. Thermal characteristics

Symbol	Parameter	Conditions	Min	Typ	Max	Unit
$R_{th(j-mb)}$	thermal resistance from junction to mounting base	Fig. 8	-	-	4.68	K/W
$R_{th(j-a)}$	thermal resistance from junction to ambient	Minimum footprint; mounted on a printed circuit board	-	95	-	K/W

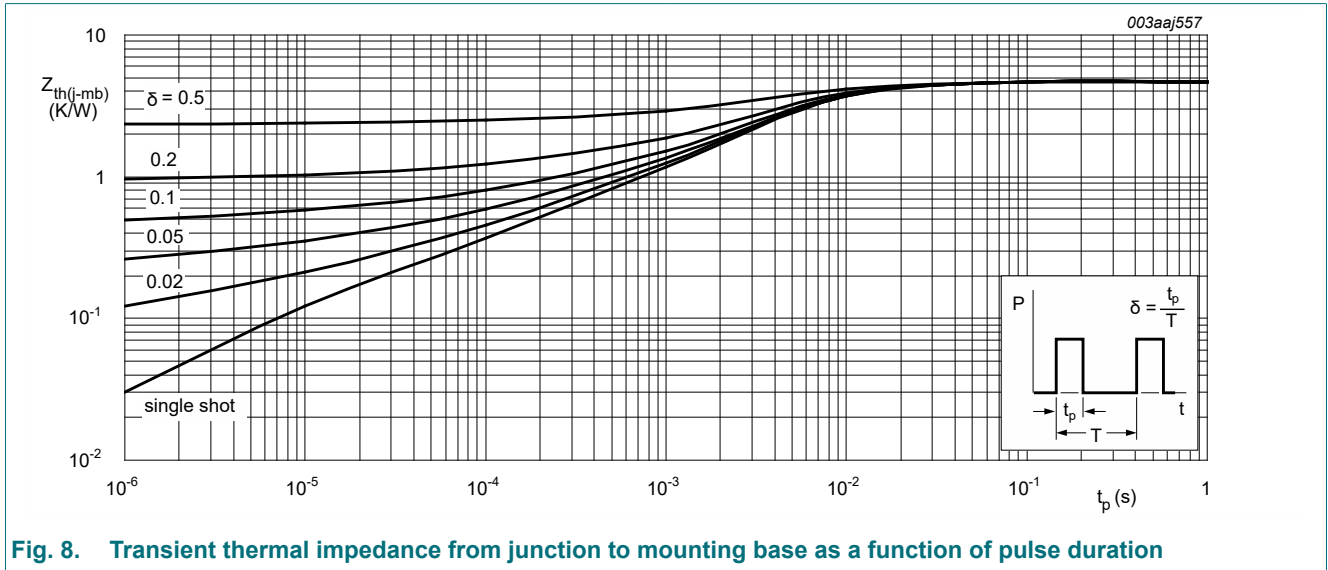

Fig. 8. Transient thermal impedance from junction to mounting base as a function of pulse duration

10. Characteristics

Table 7. Characteristics

Symbol	Parameter	Conditions	Min	Typ	Max	Unit
Static characteristics FET1 and FET2						
$V_{(BR)DSS}$	drain-source breakdown voltage	$I_D = 250 \mu A; V_{GS} = 0 V; T_j = -55 \text{ }^\circ C$	36	-	-	V
		$I_D = 250 \mu A; V_{GS} = 0 V; T_j = 25 \text{ }^\circ C$	40	-	-	V
$V_{GS(th)}$	gate-source threshold voltage	$I_D = 1 \text{ mA}; V_{DS}=V_{GS}; T_j = 25 \text{ }^\circ C; \text{ Fig. 12; Fig. 13$	1.4	1.7	2.1	V
		$I_D = 1 \text{ mA}; V_{DS}=V_{GS}; T_j = 175 \text{ }^\circ C; \text{ Fig. 12; Fig. 13$	0.5	-	-	V
		$I_D = 1 \text{ mA}; V_{DS}=V_{GS}; T_j = -55 \text{ }^\circ C; \text{ Fig. 12; Fig. 13$	-	-	2.45	V
I_{DSS}	drain leakage current	$V_{DS} = 40 \text{ V}; V_{GS} = 0 \text{ V}; T_j = 175 \text{ }^\circ C$	-	-	500	μA
		$V_{DS} = 40 \text{ V}; V_{GS} = 0 \text{ V}; T_j = 25 \text{ }^\circ C$	-	0.02	1	μA
I_{GSS}	gate leakage current	$V_{GS} = -10 \text{ V}; V_{DS} = 0 \text{ V}; T_j = 25 \text{ }^\circ C$	-	2	100	nA
		$V_{GS} = 10 \text{ V}; V_{DS} = 0 \text{ V}; T_j = 25 \text{ }^\circ C$	-	2	100	nA
R_{DSon}	drain-source on-state resistance	$V_{GS} = 5 \text{ V}; I_D = 5 \text{ A}; T_j = 25 \text{ }^\circ C; \text{ Fig. 14$	-	24	29	m Ω
		$V_{GS} = 5 \text{ V}; I_D = 5 \text{ A}; T_j = 175 \text{ }^\circ C; \text{ Fig. 14; Fig. 15$	-	48.2	58	m Ω
		$V_{GS} = 10 \text{ V}; I_D = 5 \text{ A}; T_j = 25 \text{ }^\circ C; \text{ Fig. 14$	-	19	24	m Ω

Dual N-channel 40 V, 29 mOhm logic level MOSFET in LPAK56D using Repetitive Avalanche technology

Symbol	Parameter	Conditions	Min	Typ	Max	Unit
Dynamic characteristics FET1 and FET2						
$Q_{G(tot)}$	total gate charge	$I_D = 5\text{ A}; V_{DS} = 32\text{ V}; V_{GS} = 5\text{ V};$ $T_j = 25\text{ }^\circ\text{C};$ Fig. 16 ; Fig. 17	-	6.3	-	nC
Q_{GS}	gate-source charge		-	1.4	-	nC
Q_{GD}	gate-drain charge		-	2.4	-	nC
C_{iss}	input capacitance	$V_{DS} = 25\text{ V}; V_{GS} = 0\text{ V}; f = 1\text{ MHz};$ $T_j = 25\text{ }^\circ\text{C};$ Fig. 18	-	528	701	pF
C_{oss}	output capacitance		-	95	114	pF
C_{rss}	reverse transfer capacitance		-	56	76	pF
$t_{d(on)}$	turn-on delay time	$V_{DS} = 32\text{ V}; R_L = 6.4\text{ }\Omega; V_{GS} = 5\text{ V};$ $R_{G(ext)} = 5\text{ }\Omega; T_j = 25\text{ }^\circ\text{C}$	-	6.2	-	ns
t_r	rise time		-	9.2	-	ns
$t_{d(off)}$	turn-off delay time		-	10.8	-	ns
t_f	fall time		-	8.9	-	ns
Source-drain diode FET1 and FET2						
V_{SD}	source-drain voltage	$I_S = 5\text{ A}; V_{GS} = 0\text{ V}; T_j = 25\text{ }^\circ\text{C};$ Fig. 19	-	0.83	1.2	V
t_{rr}	reverse recovery time	$I_S = 5\text{ A}; di_S/dt = -100\text{ A}/\mu\text{s}; V_{GS} = 0\text{ V};$ $V_{DS} = 20\text{ V}; T_j = 25\text{ }^\circ\text{C}$	-	15.9	-	ns
Q_r	recovered charge		-	7.6	-	nC

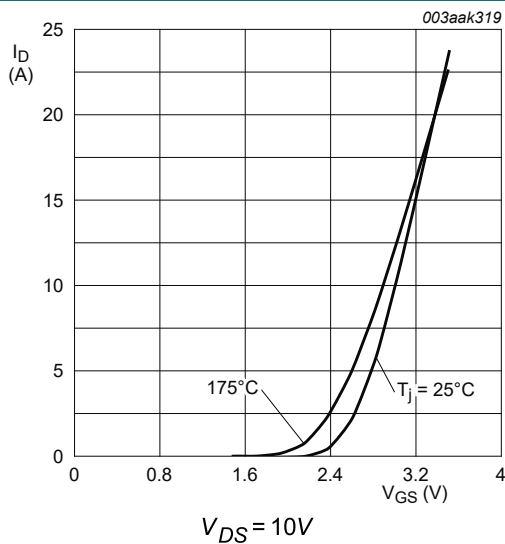

Fig. 9. Transfer characteristics; drain current as a function of gate-source voltage; typical values

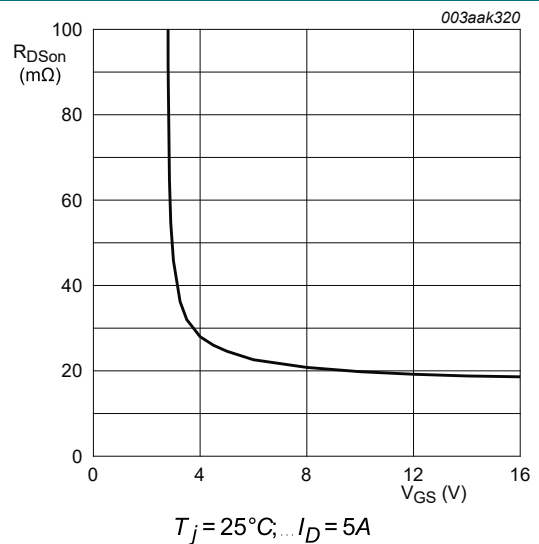
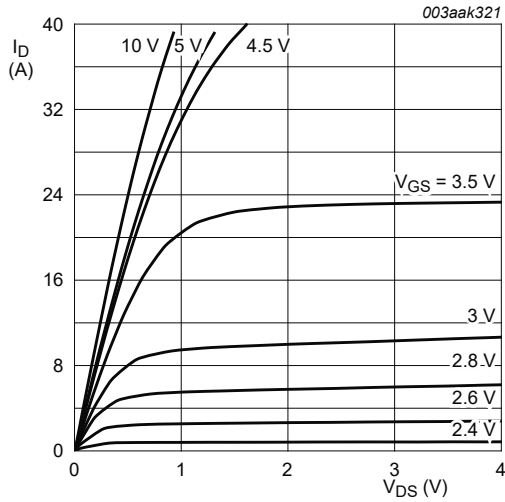

Fig. 10. Drain-source on-state resistance as a function of gate-source voltage; typical values

Dual N-channel 40 V, 29 mOhm logic level MOSFET in LPAK56D using Repetitive Avalanche technology



$T_j = 25\text{ }^\circ\text{C}; t_p = 300\text{ }\mu\text{s}$

Fig. 11. Output characteristics; drain current as a function of drain-source voltage; typical values

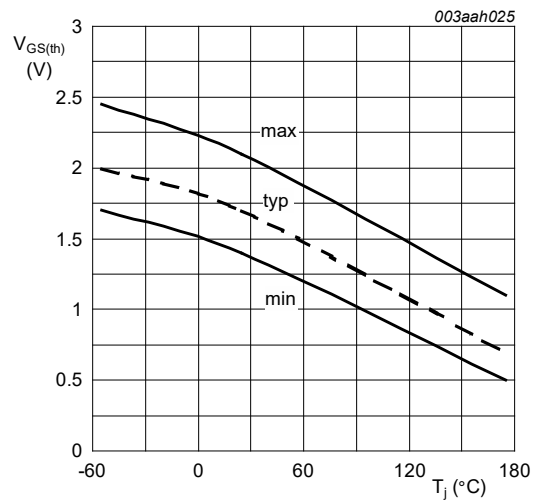

$I_D = 1\text{ mA}; V_{DS} = V_{GS}$

Fig. 12. Gate-source threshold voltage as a function of junction temperature

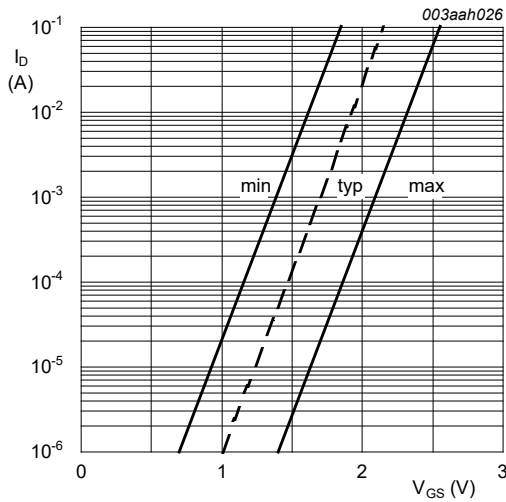

$T_j = 25\text{ }^\circ\text{C}; \dots V_{DS} = 5\text{ V}$

Fig. 13. Sub-threshold drain current as a function of gate-source voltage

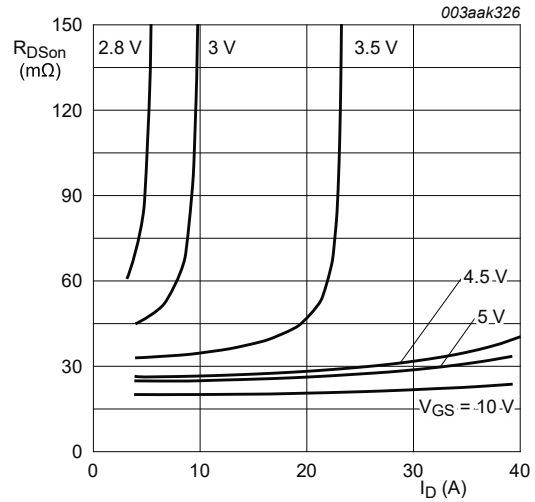

$T_j = 25\text{ }^\circ\text{C}; t_p = 300\text{ }\mu\text{s}$

Fig. 14. Drain-source on-state resistance as a function of drain current; typical values

Dual N-channel 40 V, 29 mOhm logic level MOSFET in LPAK56D using Repetitive Avalanche technology

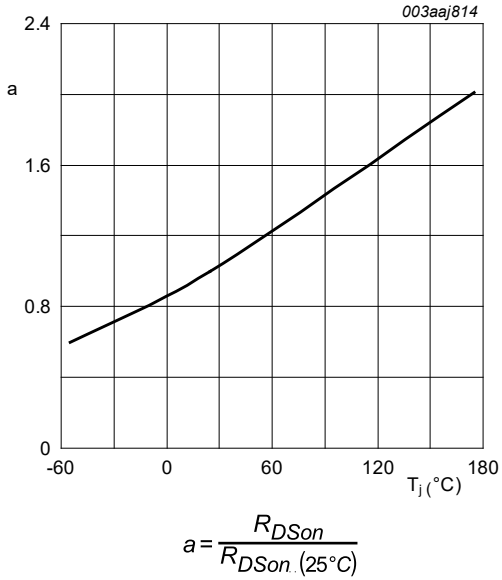

Fig. 15. Normalized drain-source on-state resistance factor as a function of junction temperature

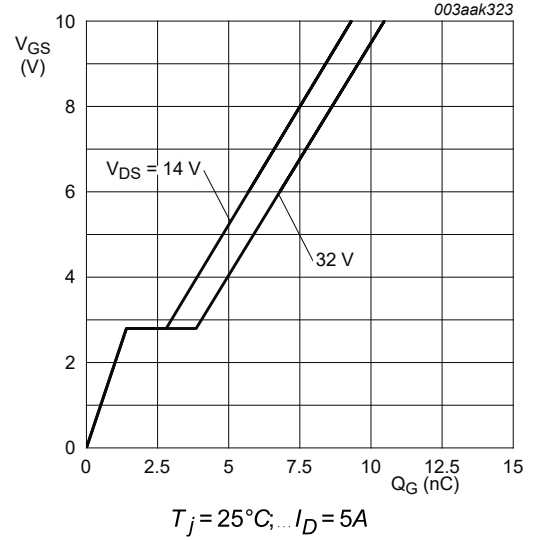

Fig. 16. Gate-source voltage as a function of gate charge; typical values

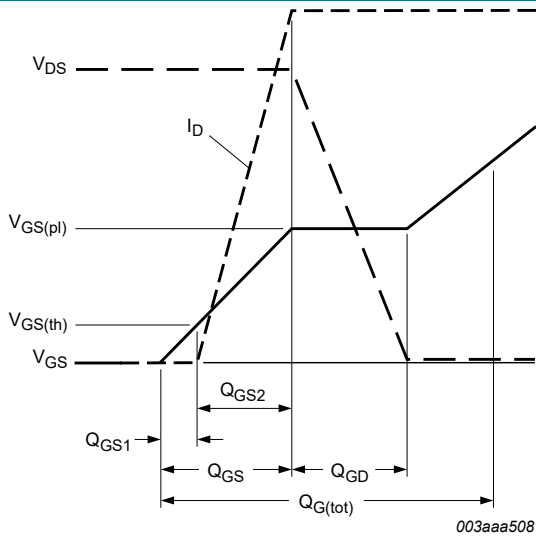

Fig. 17. Gate charge waveform definitions

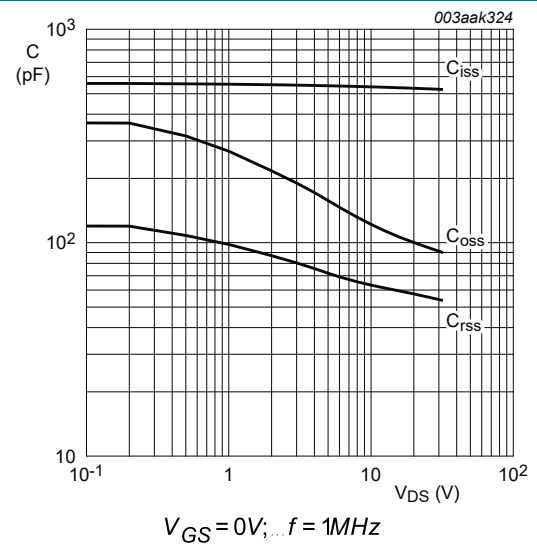

Fig. 18. Input, output and reverse transfer capacitances as a function of drain-source voltage; typical values

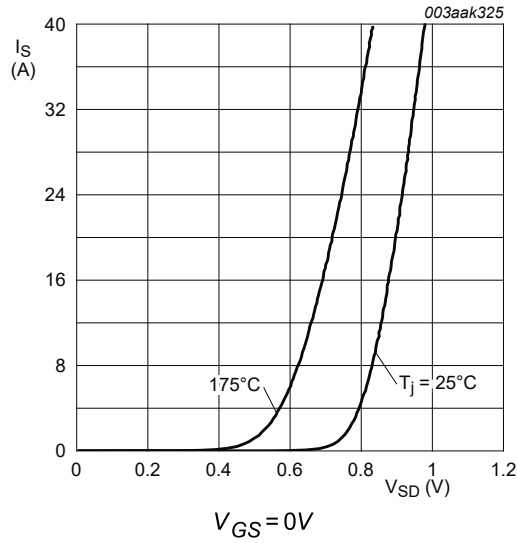

Fig. 19. Source (diode forward) current as a function of source-drain (diode forward) voltage; typical values

11. Package outline

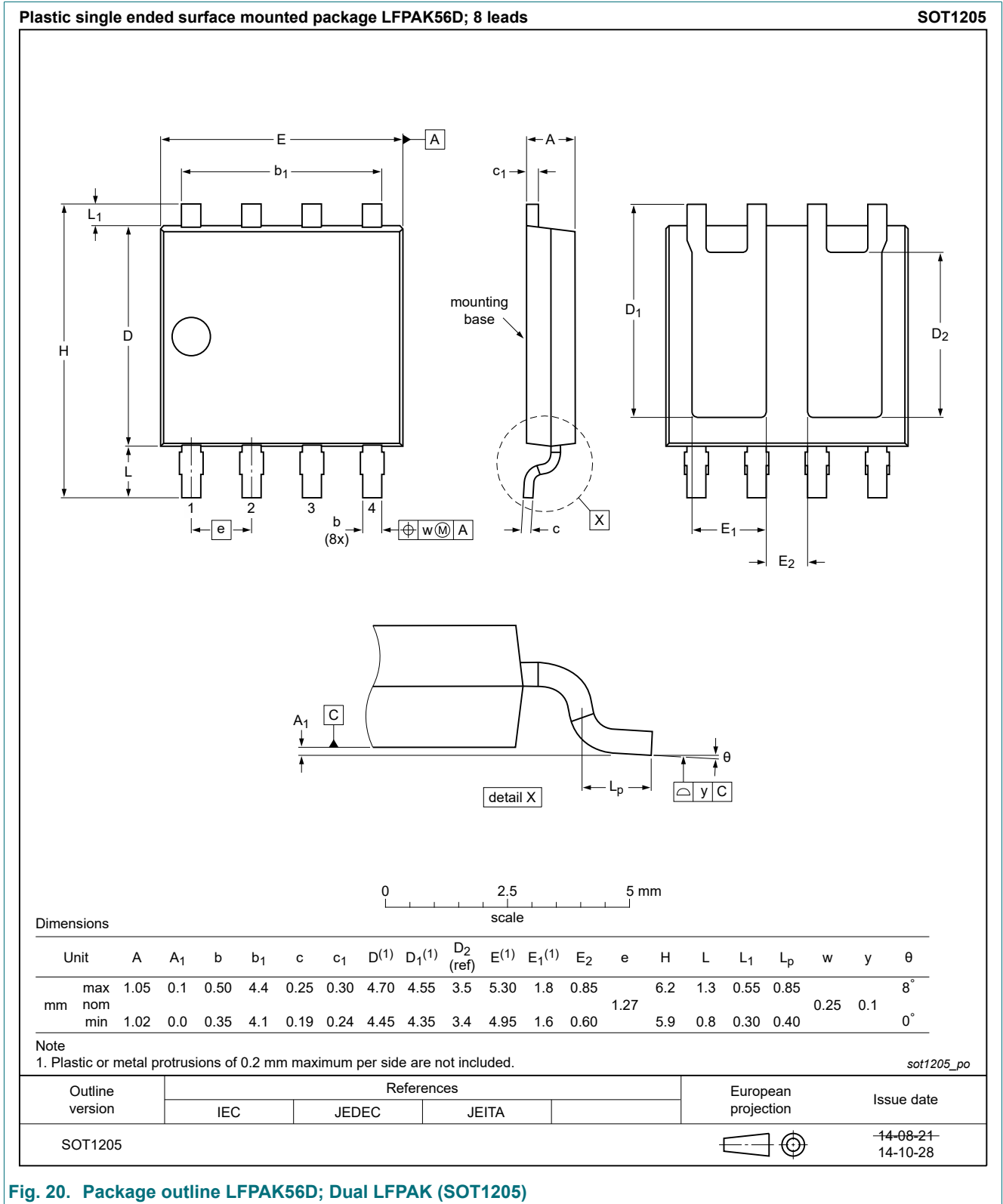

Fig. 20. Package outline LPAK56D; Dual LPAK (SOT1205)

12. Soldering

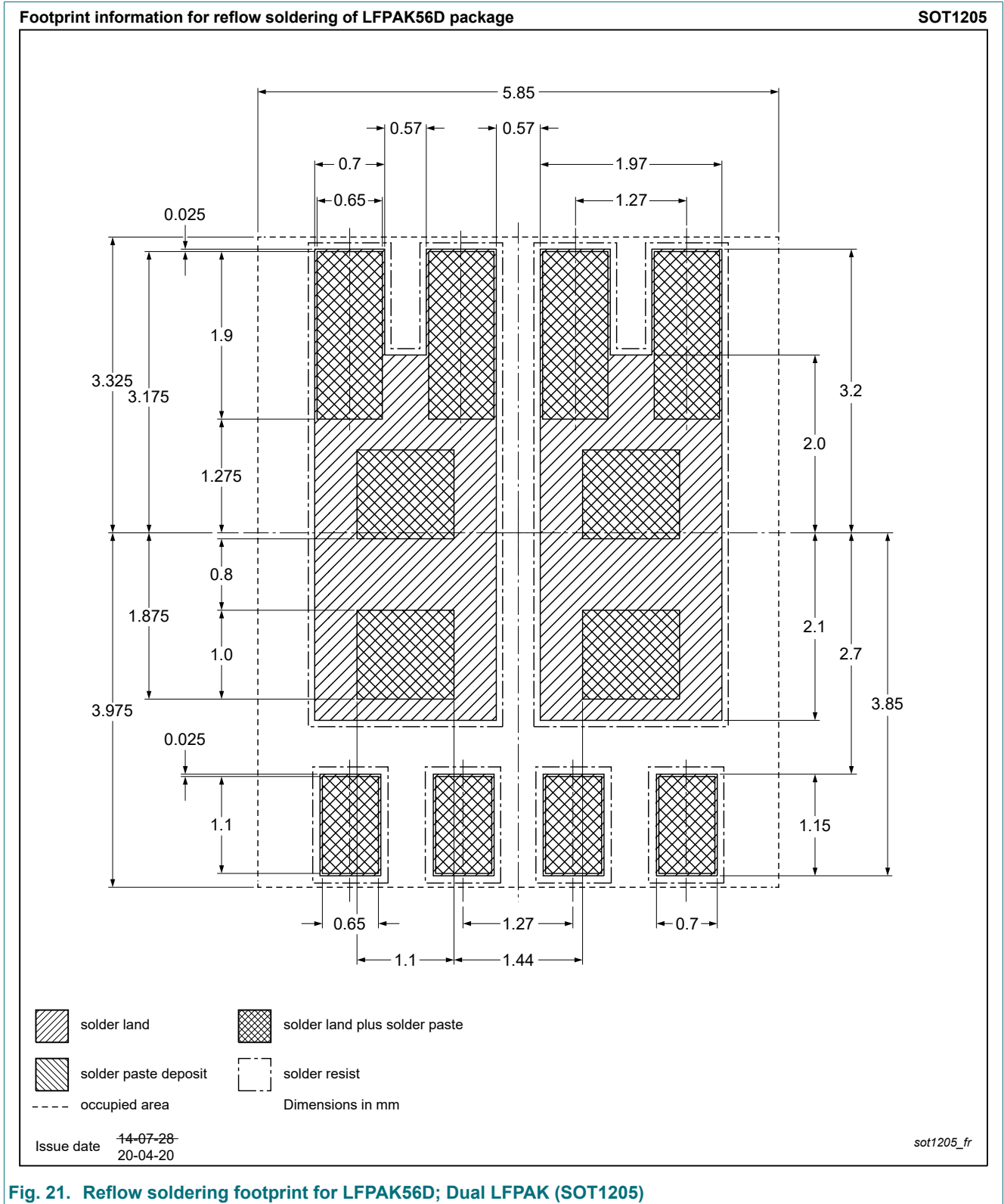

Fig. 21. Reflow soldering footprint for LPAK56D; Dual LPAK (SOT1205)

Dual N-channel 40 V, 29 mOhm logic level MOSFET in LPAK56D using Repetitive Avalanche technology

13. Legal information

Data sheet status

Document status [1][2]	Product status [3]	Definition
Objective [short] data sheet	Development	This document contains data from the objective specification for product development.
Preliminary [short] data sheet	Qualification	This document contains data from the preliminary specification.
Product [short] data sheet	Production	This document contains the product specification.

- [1] Please consult the most recently issued document before initiating or completing a design.
- [2] The term 'short data sheet' is explained in section "Definitions".
- [3] The product status of device(s) described in this document may have changed since this document was published and may differ in case of multiple devices. The latest product status information is available on the internet at <https://www.nexperia.com>.

Definitions

Draft — The document is a draft version only. The content is still under internal review and subject to formal approval, which may result in modifications or additions. Nexperia does not give any representations or warranties as to the accuracy or completeness of information included herein and shall have no liability for the consequences of use of such information.

Short data sheet — A short data sheet is an extract from a full data sheet with the same product type number(s) and title. A short data sheet is intended for quick reference only and should not be relied upon to contain detailed and full information. For detailed and full information see the relevant full data sheet, which is available on request via the local Nexperia sales office. In case of any inconsistency or conflict with the short data sheet, the full data sheet shall prevail.

Product specification — The information and data provided in a Product data sheet shall define the specification of the product as agreed between Nexperia and its customer, unless Nexperia and customer have explicitly agreed otherwise in writing. In no event however, shall an agreement be valid in which the Nexperia product is deemed to offer functions and qualities beyond those described in the Product data sheet.

Disclaimers

Limited warranty and liability — Information in this document is believed to be accurate and reliable. However, Nexperia does not give any representations or warranties, expressed or implied, as to the accuracy or completeness of such information and shall have no liability for the consequences of use of such information. Nexperia takes no responsibility for the content in this document if provided by an information source outside of Nexperia.

In no event shall Nexperia be liable for any indirect, incidental, punitive, special or consequential damages (including - without limitation - lost profits, lost savings, business interruption, costs related to the removal or replacement of any products or rework charges) whether or not such damages are based on tort (including negligence), warranty, breach of contract or any other legal theory.

Notwithstanding any damages that customer might incur for any reason whatsoever, Nexperia's aggregate and cumulative liability towards customer for the products described herein shall be limited in accordance with the Terms and conditions of commercial sale of Nexperia.

Right to make changes — Nexperia reserves the right to make changes to information published in this document, including without limitation specifications and product descriptions, at any time and without notice. This document supersedes and replaces all information supplied prior to the publication hereof.

Suitability for use in automotive applications — This Nexperia product has been qualified for use in automotive applications. Unless otherwise agreed in writing, the product is not designed, authorized or warranted to be suitable for use in life support, life-critical or safety-critical systems or

equipment, nor in applications where failure or malfunction of an Nexperia product can reasonably be expected to result in personal injury, death or severe property or environmental damage. Nexperia and its suppliers accept no liability for inclusion and/or use of Nexperia products in such equipment or applications and therefore such inclusion and/or use is at the customer's own risk.

Quick reference data — The Quick reference data is an extract of the product data given in the Limiting values and Characteristics sections of this document, and as such is not complete, exhaustive or legally binding.

Applications — Applications that are described herein for any of these products are for illustrative purposes only. Nexperia makes no representation or warranty that such applications will be suitable for the specified use without further testing or modification.

Customers are responsible for the design and operation of their applications and products using Nexperia products, and Nexperia accepts no liability for any assistance with applications or customer product design. It is customer's sole responsibility to determine whether the Nexperia product is suitable and fit for the customer's applications and products planned, as well as for the planned application and use of customer's third party customer(s). Customers should provide appropriate design and operating safeguards to minimize the risks associated with their applications and products.

Nexperia does not accept any liability related to any default, damage, costs or problem which is based on any weakness or default in the customer's applications or products, or the application or use by customer's third party customer(s). Customer is responsible for doing all necessary testing for the customer's applications and products using Nexperia products in order to avoid a default of the applications and the products or of the application or use by customer's third party customer(s). Nexperia does not accept any liability in this respect.

Limiting values — Stress above one or more limiting values (as defined in the Absolute Maximum Ratings System of IEC 60134) will cause permanent damage to the device. Limiting values are stress ratings only and (proper) operation of the device at these or any other conditions above those given in the Recommended operating conditions section (if present) or the Characteristics sections of this document is not warranted. Constant or repeated exposure to limiting values will permanently and irreversibly affect the quality and reliability of the device.

Terms and conditions of commercial sale — Nexperia products are sold subject to the general terms and conditions of commercial sale, as published at <http://www.nexperia.com/profile/terms>, unless otherwise agreed in a valid written individual agreement. In case an individual agreement is concluded only the terms and conditions of the respective agreement shall apply. Nexperia hereby expressly objects to applying the customer's general terms and conditions with regard to the purchase of Nexperia products by customer.

No offer to sell or license — Nothing in this document may be interpreted or construed as an offer to sell products that is open for acceptance or the grant, conveyance or implication of any license under any copyrights, patents or other industrial or intellectual property rights.

Export control — This document as well as the item(s) described herein may be subject to export control regulations. Export might require a prior authorization from competent authorities.

Translations — A non-English (translated) version of a document is for reference only. The English version shall prevail in case of any discrepancy between the translated and English versions.

Trademarks

Notice: All referenced brands, product names, service names and trademarks are the property of their respective owners.

Contents

1. General description.....	1
2. Features and benefits.....	1
3. Applications.....	1
4. Quick reference data.....	1
5. Pinning information.....	2
6. Ordering information.....	2
7. Marking.....	2
8. Limiting values.....	2
9. Thermal characteristics.....	5
10. Characteristics.....	5
11. Package outline.....	10
12. Soldering.....	11
13. Legal information.....	12

© Nexperia B.V. 2020. All rights reserved



For more information, please visit: <http://www.nexperia.com>

For sales office addresses, please send an email to: salesaddresses@nexperia.com





Date of release: 2 December 2020

Looking for pricing, stock, or lifecycle information?

Click below to explore more details on WIN SOURCE:

-  [View BUK9K25-40RAX on WIN SOURCE](#)
-  [Nexperia USA Inc. Information](#)

Optimize Your Supply Chain with WIN SOURCE Solutions

-  Global Sourcing Solution
-  Obsolete Management
-  Cost Control Management
-  Shortage Management
-  Alternative Solution
-  Excess Inventory Management