



THE DATASHEET OF
553-2223-100F



3mm

LED CBI® Circuit Board Indicator Bi-level For Backlighting



553-22xx-100

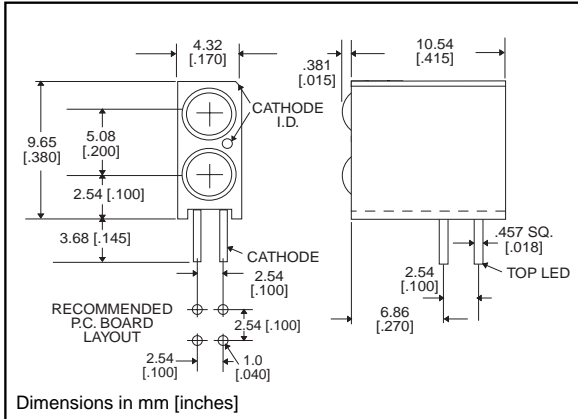

Standard Polarity shown in drawing: Cathode right

Features

- Narrow viewing angle and extended housing reduce light bleed
- Multiple CBIs form horizontal LED arrays on 4.45mm (0.175") center-lines.
- High Contrast, UL 94 V-0 rated, black housing
- Oxygen index: 32%
- Polymer content: PBT, 0.208 g
- Housing stand-offs facilitate PCB cleaning
- Solderability per MIL-STD-202F, method 208F
- LEDs are safe for direct viewing per IEC 825-1, EN-60825-1
- Compatible with:
 - 551-xx02 Single
 - 564-2210-xxx Tri-Level
 - 568-221x-xxx Quad-Level

PART NO.

HIGH EFFICIENCY, TINTED,

NON DIFFUSED

553-2211-100

553-2222-100

553-2223-100

553-2232-100

553-2233-100

COLOR*

- Red-Red
- Green-Green
- Green-Yellow
- Yellow-Green
- Yellow-Yellow

* Top-Bottom LED

REVERSE POLARITY OPTION AVAILABLE

See Part Number Ordering Code below.

Custom Combinations

- Contact factory for information on custom color combinations.

Tolerance note: As noted, otherwise:

- LED Protrusion: ± 0.04 mm [± 0.016]
- CBI Housing: ± 0.02 mm [± 0.008]

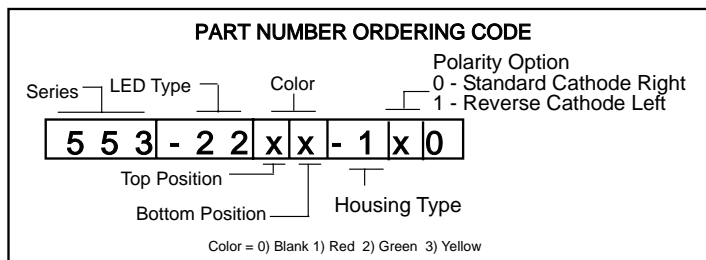

Typical Operating Characteristics @ TA=25°C

See LED data sheet for additional information
See page 4-70 and 4-71 for Reference Only LED Drive Circuit Examples. See page 4-72 for Pin Out

Color	Peak Wavelength nm	Iv mcd	V _F Volts*	Test Current (mA)	Viewing Angle (2 θ 1/2)	LED Data sheet	Page #
Red	635	29	2	10	45°	521-9432	4-61
Green	565	50	2.1	10	45°	521-9430	4-61
Yellow	585	20	2.1	10	45°	521-9431	4-61

* I_F = 20mA

CBI ARRAYS .200 PITCH

Dialight offers its Multiarray to reduce insertions and to assure indicator alignment. Multiarrays mount indicators on .200 centers. These assemblies are available in arrays of 2 to 6. See pages 4-41 and 4-42 for information. Call factory for information on .185 pitched arrays.

3mm Discrete LED
High Efficiency
Tinted, Non-Diffused

Dialight

521-9430, -9431, -9432

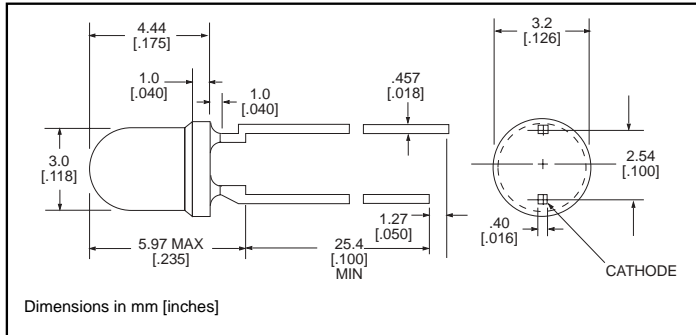

PART NO.

COLOR

521-9430
 521-9431
 521-9432

Green
 Yellow
 Red

MOUNTING CLIP: 515-0006
 located on page 4-65

ABSOLUTE MAXIMUM RATINGS ($T_A=25^\circ\text{C}$)

	Green -9430	Yellow -9431	Red -9432
Power Dissipation (mW)	100	60	100
Forward Current (mA)	30	20	30
Derating (mA/°C) From 50°C	.4	.25	.4
Peak Current (mA) Pulse width = 100µs	120	80	120
Operating Temperature (°C)	-55/+100	-55/+100	-55/+100
Storage Temperature (°C)	-55/+100	-55/+100	-55/+100
Soldering Temperature	260°C, 5 seconds, 1.6 mm from case		

Solder Adherence per MIL-STD-202E, Method 208C

OPERATING CHARACTERISTICS ($T_A=25^\circ\text{C}$)

		Green -9430	Yellow -9431	Red -9432
Luminous Intensity (mcd) $I_F=10\text{mA}$	Min.	32	10	8.7
	Typical	50	20	29
Peak Wavelength (nm) λ Peak	Typical	565	585	635
Viewing Angle ($2\theta_{1/2}$)	Typical	45°	45°	45°
Forward Voltage (V) $I_F=20\text{mA}$	Typical	2.1	2.1	2
	Max.	2.8	2.8	2.8

$\theta_{1/2}$ is the off axis angle at which the luminous intensity is half the axial luminous intensity

4





Looking for pricing, stock, or lifecycle information?

Click below to explore more details on WIN SOURCE:

 [View 553-2223-100F on WIN SOURCE](#)

 [Dialight Information](#)

Optimize Your Supply Chain with WIN SOURCE Solutions

-  Global Sourcing Solution
-  Obsolete Management
-  Cost Control Management
-  Shortage Management
-  Alternative Solution
-  Excess Inventory Management