



**THE DATASHEET OF
R161185000**



**RIGHT ANGLE PLUG FULL CRIMP-TYPE
CABLE 10/50 S**

R161.185.000
SERIES N

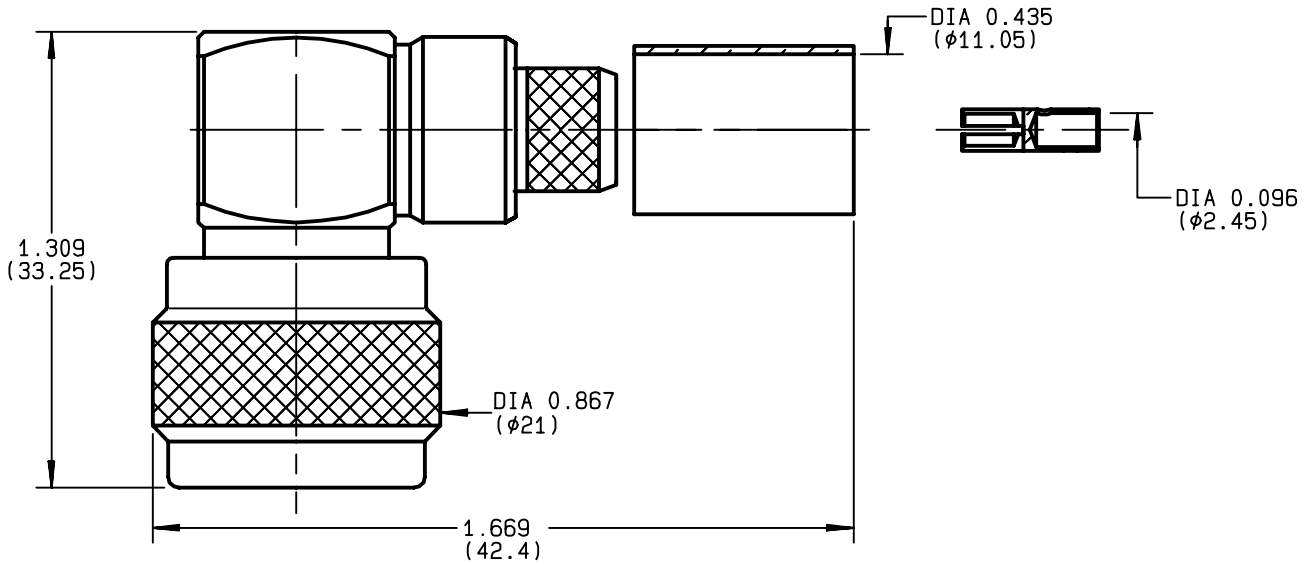

NOMINAL IMPEDANCE	50 Ω	CABLES : KX 4
FREQUENCY RANGE	0-11 GHz	RG 165
TEMPERATURE RATING	-55/+155 °C	RG 213
V.S.W.R	1.70 + x F(GHz)Maxi	
RF INSERTION LOSS	0.07 √F(GHz) dB Maxi	
VOLTAGE RATING	1400 Veff Maxi	
DIELECTRIC WITHSTANDING VOLTAGE	2500 Veff Mini	
INSULATION RESISTANCE	5000 MΩMini	OTHERS CHARACTERISTICS
HERMETIC SEAL	NA Atm.cm ³ /s	CABLE RETENTION 300 N Mini
LEAKAGE (pressurized only)	NA	CENTER CONTACT RETENTION
MECHANICAL DURABILITY	500 Cycles	Axial force - mating end 27 N Mini
WEIGHT	45 gr	Axial force - opposite end 27 N Mini
SPECIFICATION		Torque NA cm.N Mini
		RECOMMENDED TORQUES
		Mating 130 cm.N
		Panel nut NA cm.N
		Clamp nut NA cm.N

CONNECTOR PARTS	MATERIALS	FINISH	(all values are given in micrometers)
BODY	BRASS	BBR 2	
OUTER CONTACT	BRASS	BBR 2	
CENTER CONTACT	BRASS	GOLD 0.5 OVER NICKEL 2	
INSULATOR	PTFE	-	
GASKET	SILICONE RUBBER	-	
OTHERS PIECES	BRASS	BBR 2	

ISSUE	CREATION DATE	FILE PART-NUMBER
9813T03	18/02/1993	EPC 96-07



BONMINI

The information given here is subject to change without notice.
Design changes may be in order to improve the product .

Connect to the future



R161.185.000

ISSUE **9813T03** SERIES **N**

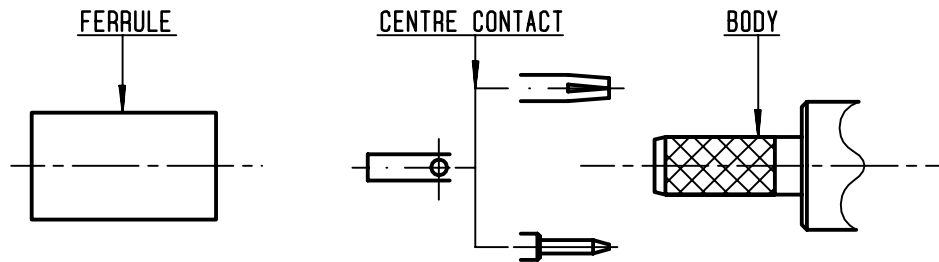

①

Slide onto the cable the ferrule .
-
Strip the cable .
-
-

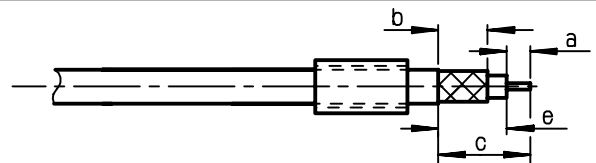

Stripping	a	b	c	d	e
inch	0.177	0.315	0.591	0	0.413
mm	4.5	8	15		10.5

②

Slide on centre contact until it bottoms against cable dielectrique .
Crimp centre contact , crimping tool R 282 231 000 (Hex. : .10) or crimping tool R 282 293 000 (M22520/5-01) + dies R 282 235 116 (Y 116 DANIELS) .
-
-

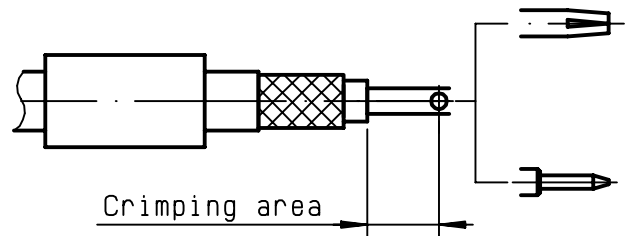

③

Fan the braid .
Slide cable into the body until bottoms against insulator .
Slide ferrule over the braid .
(In direction F)

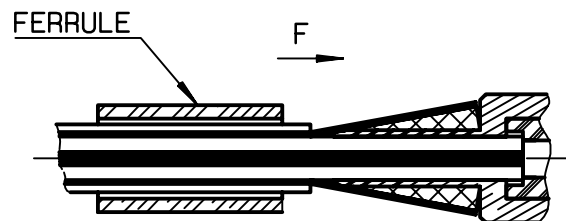

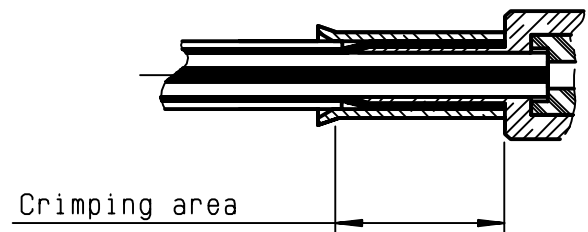

④

Crimp the ferrule with crimping tool R 282 231 000 (Hex. : .415) or crimping tool R 282 293 000 (M22520/5-01) + dies R 282 235 116 (Y 116 DANIELS) .
Cut the excess of braid .
-
-



Looking for pricing, stock, or lifecycle information?

Click below to explore more details on WIN SOURCE:

-  [View R161185000 on WIN SOURCE](#)
-  [Radiall USA, Inc. Information](#)

Optimize Your Supply Chain with WIN SOURCE Solutions

-  Global Sourcing Solution
-  Obsolete Management
-  Cost Control Management
-  Shortage Management
-  Alternative Solution
-  Excess Inventory Management