

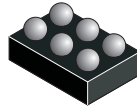

**THE DATASHEET OF
CSD75205W1015**





P-Channel NexFET™ Power MOSFET

FEATURES

- Dual P-Ch MOSFETs
- Common Source Configuration
- Small Footprint 1mm x 1.5mm
- Gate-Source Voltage Clamp
- Gate ESD Protection –3kV
- Pb Free
- RoHS Compliant
- Halogen Free

APPLICATIONS

- Battery Management
- Load Switch
- Battery Protection

DESCRIPTION

The device has been designed to deliver the lowest on resistance and gate charge in the smallest outline possible with excellent thermal characteristics in an ultra low profile. Low on resistance coupled with the small footprint and low profile make the device ideal for battery operated space constrained applications.

Figure 1. Top View

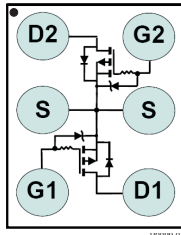

PRODUCT SUMMARY

V_{DS}	Drain to Source Voltage	-20	V
Q_g	Gate Charge Total (-4.5V)	1.6	nC
Q_{gd}	Gate Charge Gate to Drain	0.4	nC
$R_{DS(on)}$	Drain to Source On Resistance	$V_{GS} = -1.8V$	145 mΩ
		$V_{GS} = -2.5V$	115 mΩ
		$V_{GS} = -4.5V$	95 mΩ
$R_{D1D2(on)}$	Drain to Drain On Resistance	$V_{GS} = -1.8V$	245 mΩ
		$V_{GS} = -2.5V$	180 mΩ
		$V_{GS} = -4.5V$	140 mΩ
$V_{GS(th)}$	Threshold Voltage	-0.65	V

ORDERING INFORMATION

Device	Package	Media	Qty	Ship
CSD75205W1015	1-mm x 1.5-mm Wafer Level Package	7-Inch Reel	3000	Tape and Reel

ABSOLUTE MAXIMUM RATINGS

$T_A = 25^\circ C$ unless otherwise stated		VALUE	UNIT
V_{DS}	Drain to Source Voltage	-20	V
V_{GS}	Gate to Source Voltage	-6	V
I_{DS}	Continuous Drain to Source Current, $T_C = 25^\circ C^{(1)}$	-1.2	A
	Pulsed Drain to Source Current, $T_C = 25^\circ C^{(2)}$	-9.6	A
I_S	Continuous Source Pin Current	-2.3	A
	Pulsed Source Pin Current ⁽²⁾	-30	A
I_G	Continuous Gate Clamp Current	-0.5	A
	Pulsed Gate Clamp Current ⁽²⁾	-7	A
P_D	Power Dissipation ⁽¹⁾	0.75	W
T_J, T_{STG}	Operating Junction and Storage Temperature Range	-55 to 150	$^\circ C$

- (1) Per device, both sides in conduction
- (2) Pulse duration 10μs, duty cycle ≤2%

$R_{DS(on)}$ vs V_{GS}

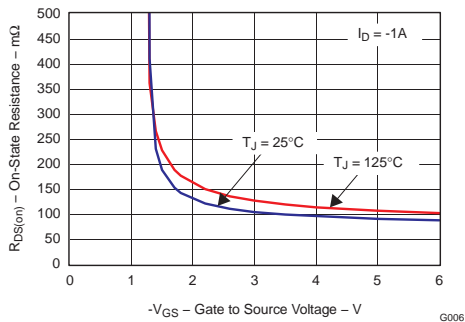

$R_{D1D2(on)}$ vs V_{GS}

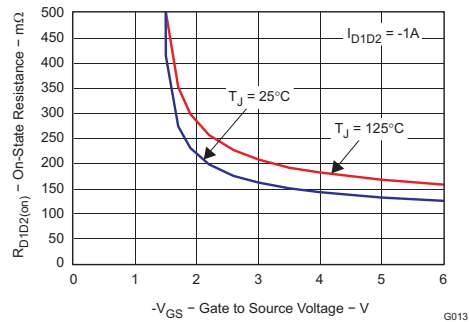

Please be aware that an important notice concerning availability, standard warranty, and use in critical applications of Texas Instruments semiconductor products and disclaimers thereto appears at the end of this data sheet.



These devices have limited built-in ESD protection. The leads should be shorted together or the device placed in conductive foam during storage or handling to prevent electrostatic damage to the MOS gates.

ELECTRICAL CHARACTERISTICS

$T_A = 25^\circ\text{C}$ unless otherwise stated

PARAMETER		TEST CONDITIONS	MIN	TYP	MAX	UNIT	
Static Characteristics							
BV_{DSS}	Drain to Source Voltage	$V_{GS} = 0V, I_{DS} = -250\mu A$	-20			V	
BV_{GSS}	Gate to Source Voltage	$V_{DS} = 0V, I_G = -250\mu A$	-6.1		-7.2	V	
I_{DSS}	Drain to Source Leakage Current	$V_{GS} = 0V, V_{DS} = -16V$			-1	μA	
I_{GSS}	Gate to Source Leakage Current	$V_{DS} = 0V, V_{GS} = -6V$			-100	nA	
$V_{GS(th)}$	Gate to Source Threshold Voltage	$V_{DS} = V_{GS}, I_{DS} = -250\mu A$	-0.45	-0.65	-0.85	V	
$R_{DS(on)}$	Drain to Source On Resistance	$V_{GS} = -1.8V, I_D = -1A$		145	180	m Ω	
		$V_{GS} = -2.5V, I_D = -1A$		115	145	m Ω	
		$V_{GS} = -4.5V, I_D = -1A$		95	120	m Ω	
$R_{D1D2(on)}$	Source to Drain On Resistance	$V_{GS} = -1.8V, I_{D1D2} = -1A$		245	305	m Ω	
		$V_{GS} = -2.5V, I_{D1D2} = -1A$		180	225	m Ω	
		$V_{GS} = -4.5V, I_{D1D2} = -1A$		140	175	m Ω	
g_{fs}	Transconductance	$V_{DS} = -10V, I_D = -1A$		5		S	
Dynamic Characteristics							
C_{ISS}	Input Capacitance	$V_{GS} = 0V, V_{DS} = -10V,$ $f = 1MHz$		205	265	pF	
C_{OSS}	Output Capacitance			80	105	pF	
C_{RSS}	Reverse Transfer Capacitance			25	33	pF	
Q_g	Gate Charge Total (-4.5V)			1.6	2.2	nC	
Q_{gd}	Gate Charge - Gate to Drain		$V_{DS} = -10V,$ $I_{DS} = -1A$		0.4		nC
Q_{gs}	Gate Charge - Gate to Source				0.3		nC
$Q_{g(th)}$	Gate Charge at V_{th}				0.12		nC
Q_{OSS}	Output Charge	$V_{DS} = -10.25V, V_{GS} = 0V$		1.5		nC	
$t_{d(on)}$	Turn On Delay Time	$V_{DS} = -10V, V_{GS} = -4.5V,$ $I_{DS} = -1A, R_G = 10\Omega$		6.3		ns	
t_r	Rise Time			5.3		ns	
$t_{d(off)}$	Turn Off Delay Time			32		ns	
t_f	Fall Time			17		ns	
Diode Characteristics							
V_{SD}	Diode Forward Voltage	$I_{DS} = -1A, V_{GS} = 0V$	-0.75		-1	V	
Q_{rr}	Reverse Recovery Charge	$V_{dd} = -10.25V, I_F = -1A, di/dt = 200A/\mu s$		5.7		nC	
t_{rr}	Reverse Recovery Time	$V_{dd} = -10.25V, I_F = -1A, di/dt = 200A/\mu s$		15.7		ns	

THERMAL CHARACTERISTICS

$T_A = 25^\circ\text{C}$ unless otherwise stated

PARAMETER		MIN	TYP	MAX	UNIT
$R_{\theta JA}$	Thermal Resistance Junction to Ambient ^{(1) (2)}			212	$^\circ\text{C}/\text{W}$
	Thermal Resistance Junction to Ambient ^{(2) (3)}			119	$^\circ\text{C}/\text{W}$

(1) Device mounted on FR4 material with Minimum Cu mounting area

(2) Measured with both devices biased in a parallel condition.

(3) Device mounted on FR4 material with 1-inch² (6.45-cm²), 2-oz. (0.071-mm thick) Cu.

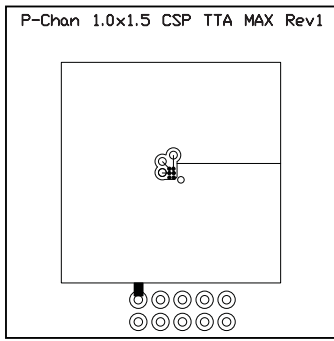

M0155-01

Max $R_{\theta JA} = 119^{\circ}\text{C/W}$
when mounted on
1 inch² (6.45 cm²) of 2-
oz. (0.071-mm thick)
Cu.

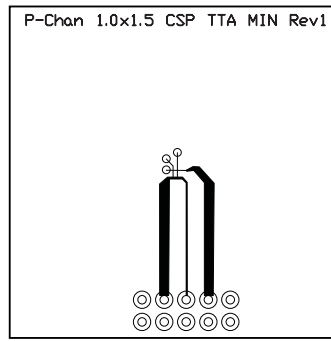

M0156-01

Max $R_{\theta JA} = 212^{\circ}\text{C/W}$
when mounted on
minimum pad area of
2-oz. (0.071-mm thick)
Cu.

TYPICAL MOSFET CHARACTERISTICS

Graphs are Per MOSFET at $T_A = 25^{\circ}\text{C}$, unless stated otherwise. Drain to Drain measurements are done with both MOSFETs in series (common source configuration).

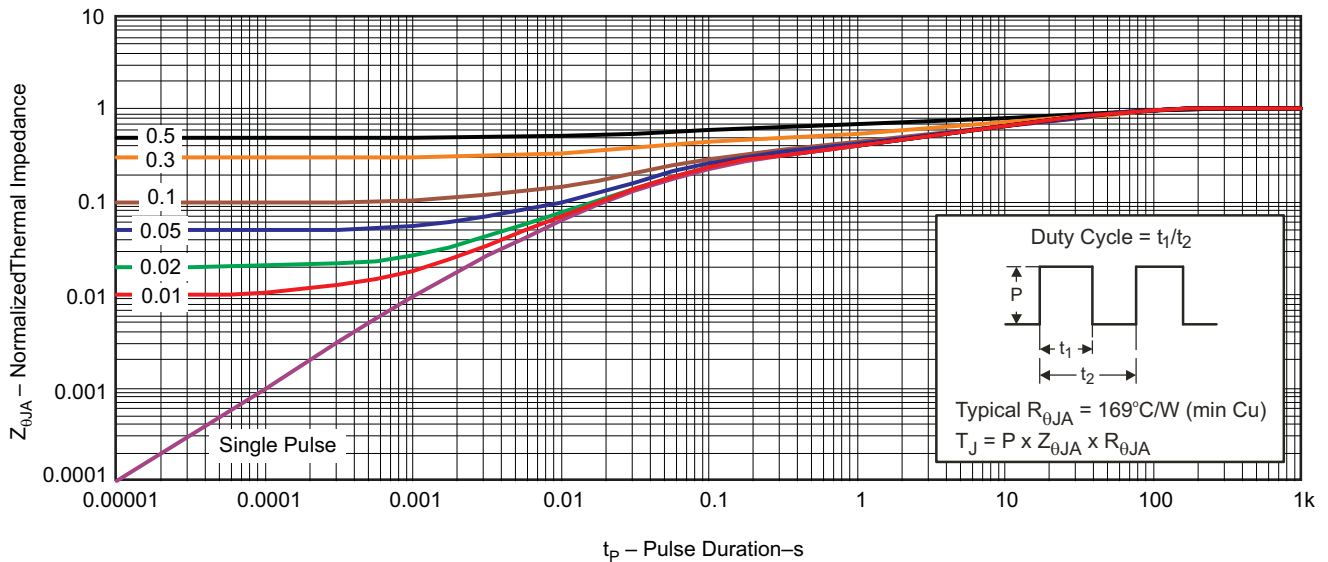

G012

Figure 2. Transient Thermal Impedance

TYPICAL MOSFET CHARACTERISTICS (continued)

Graphs are Per MOSFET at $T_A = 25^\circ\text{C}$, unless stated otherwise. Drain to Drain measurements are done with both MOSFETs in series (common source configuration).

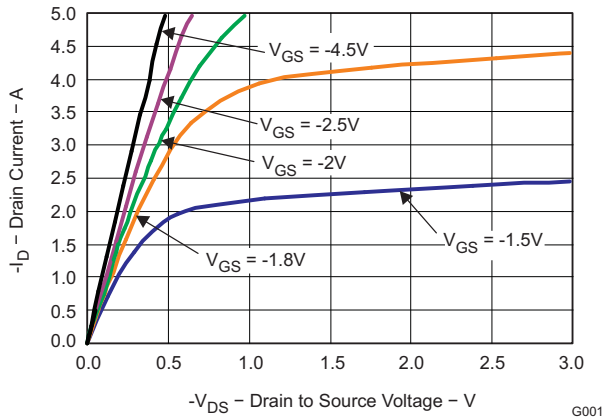

Figure 3. Saturation Characteristics

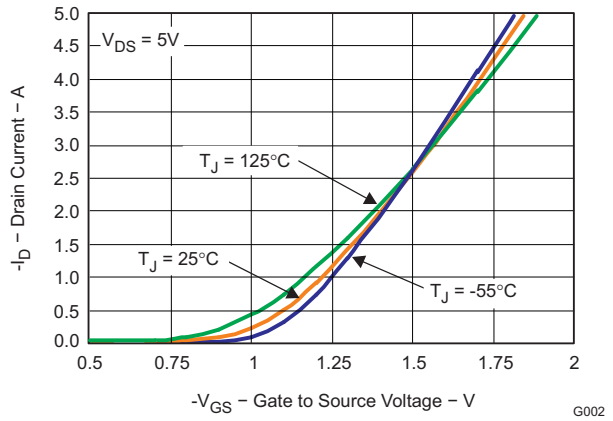

Figure 4. Transfer Characteristics

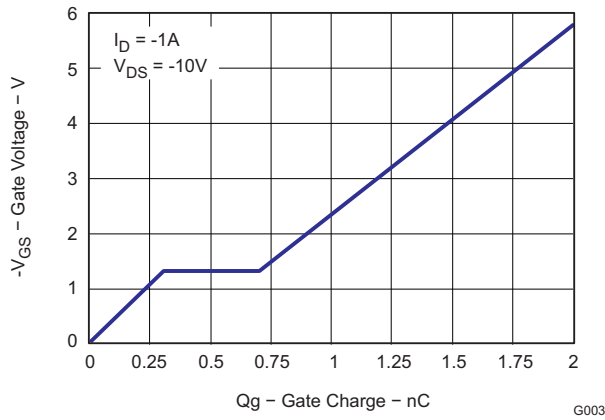

Figure 5. Gate Charge

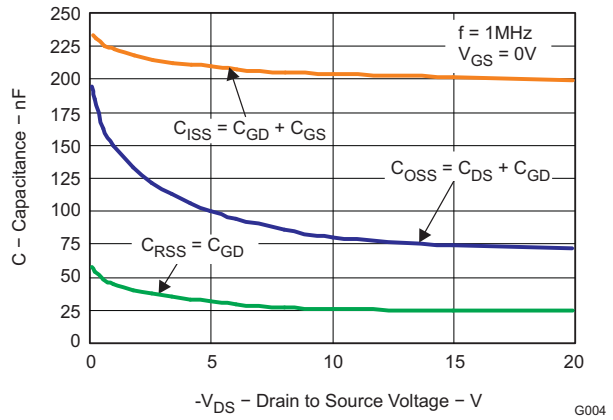

Figure 6. Capacitance

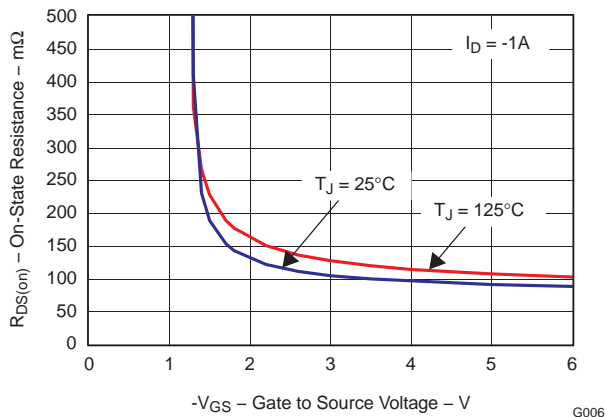

Figure 7. On-State Resistance vs. Gate Voltage

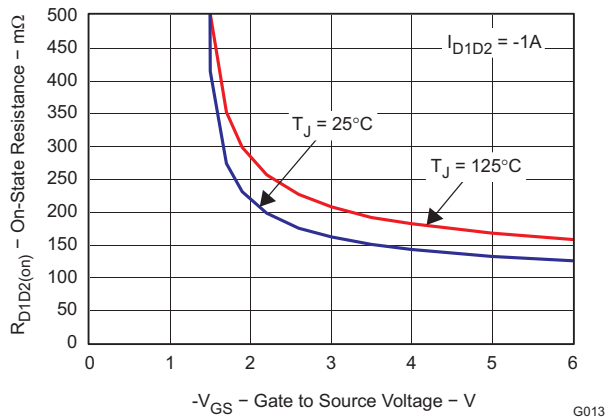

Figure 8. On-State Resistance vs. Gate Voltage

TYPICAL MOSFET CHARACTERISTICS (continued)

Graphs are Per MOSFET at $T_A = 25^\circ\text{C}$, unless stated otherwise. Drain to Drain measurements are done with both MOSFETs in series (common source configuration).

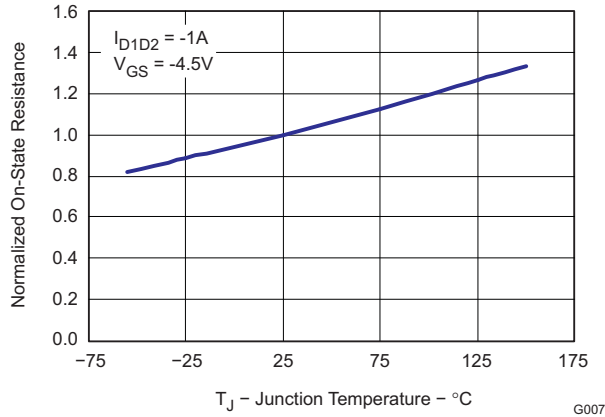

Figure 9. Normalized On-State Resistance vs. Temperature

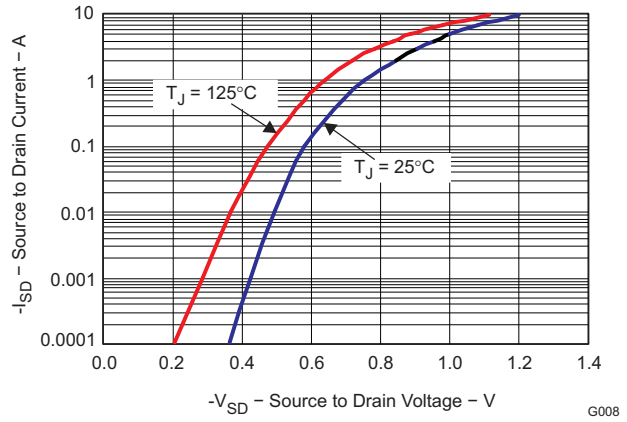

Figure 10. Typical Diode Forward Voltage

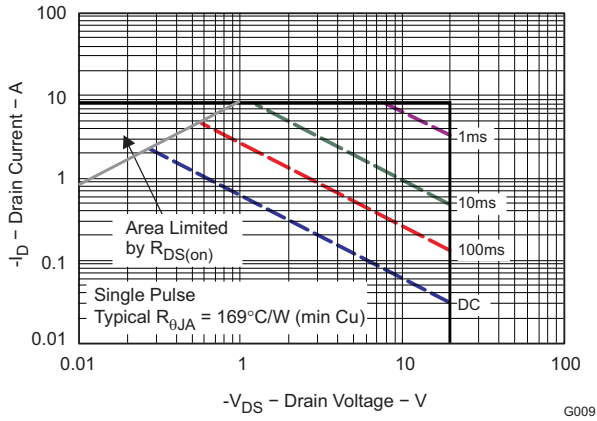

Figure 11. Maximum Safe Operating Area

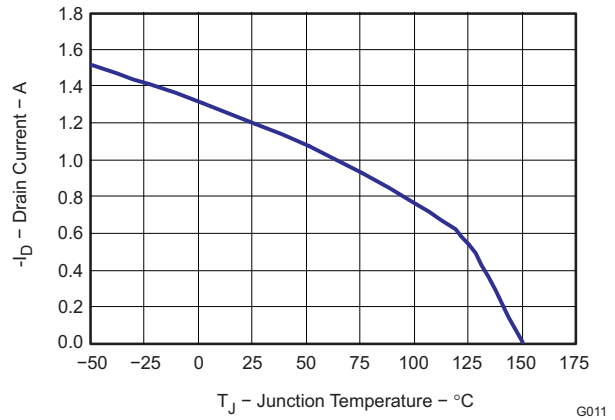

Figure 12. Maximum Drain Current vs. Temperature

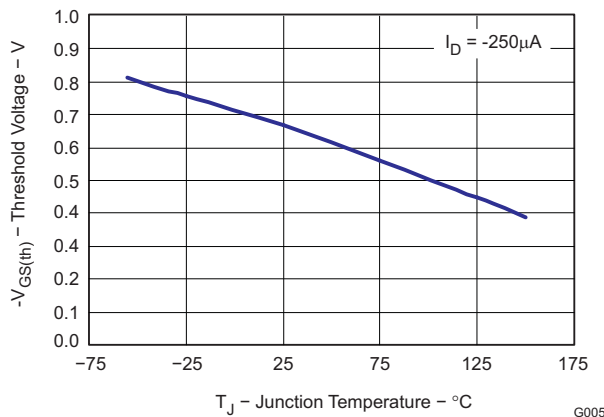
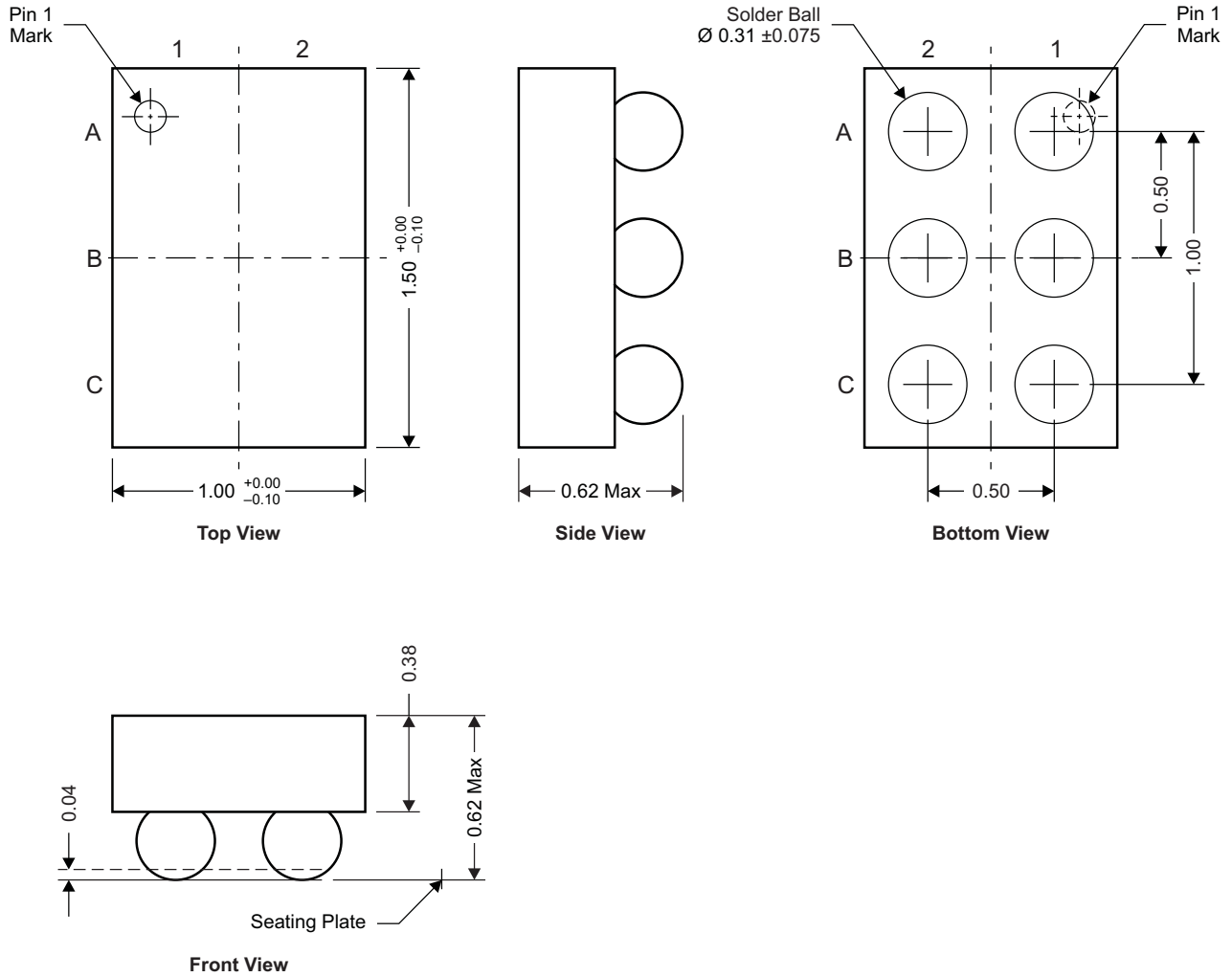

Figure 13. Threshold Voltage vs. Temperature

MECHANICAL DATA

CSD75205W1015 Package Dimensions



NOTE: All dimensions are in mm (unless otherwise specified)

M0157-01

Pinout

POSITION	DESIGNATION
B1, B2	Source
C1	Gate1
C2	Drain1
A2	Gate2
A1	Drain2

Figure 14. Land Pattern Recommendation

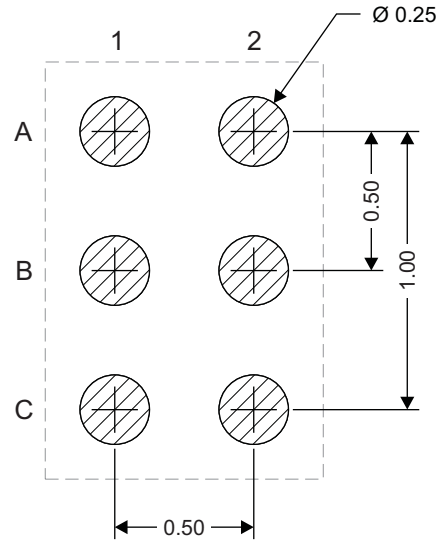

M0158-01

NOTE: All dimensions are in mm (unless otherwise specified)

Tape and Reel Information

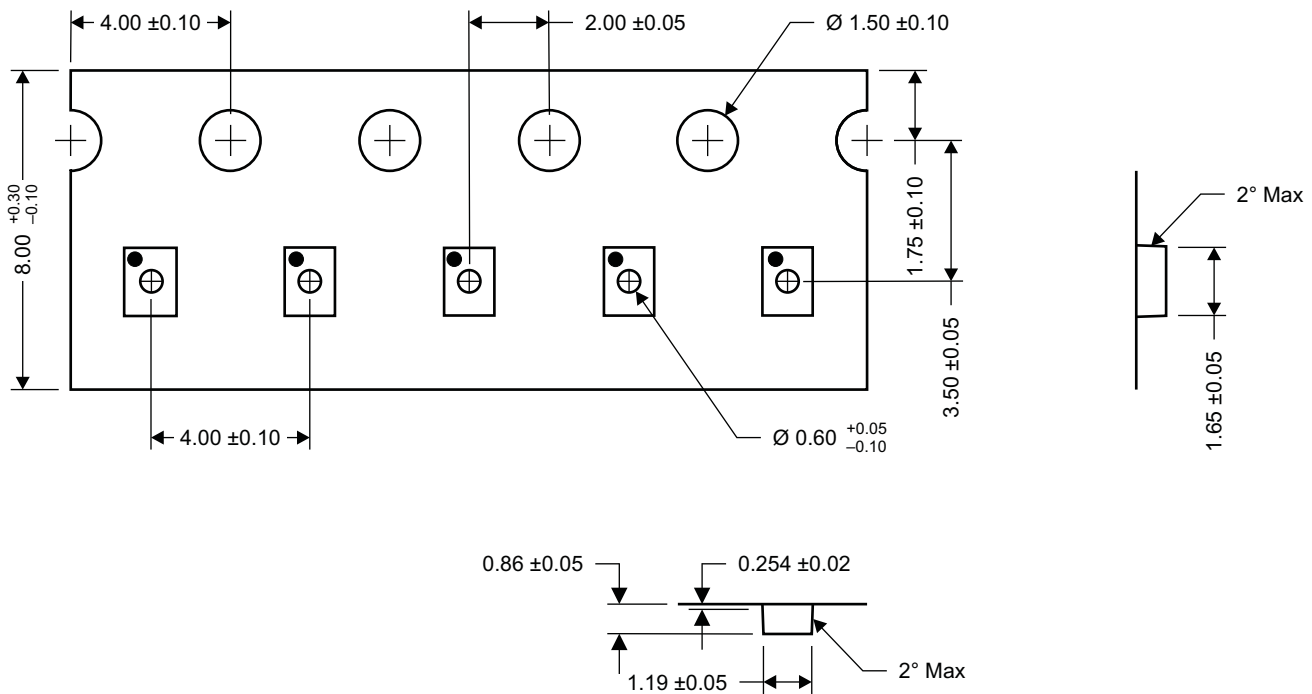

M0159-01

NOTE: All dimensions are in mm (unless otherwise specified)

REVISION HISTORY

Changes from Original (October 2009) to Revision A **Page**

- Deleted the Package Marking Information section [7](#)
-

Changes from Revision A (October 2009) to Revision B **Page**

- Changed the CSD75205W1015 Package Dimensions section. Top View From: 15.00 To: 1.50 [6](#)
-

IMPORTANT NOTICE

Texas Instruments Incorporated and its subsidiaries (TI) reserve the right to make corrections, modifications, enhancements, improvements, and other changes to its products and services at any time and to discontinue any product or service without notice. Customers should obtain the latest relevant information before placing orders and should verify that such information is current and complete. All products are sold subject to TI's terms and conditions of sale supplied at the time of order acknowledgment.

TI warrants performance of its hardware products to the specifications applicable at the time of sale in accordance with TI's standard warranty. Testing and other quality control techniques are used to the extent TI deems necessary to support this warranty. Except where mandated by government requirements, testing of all parameters of each product is not necessarily performed.

TI assumes no liability for applications assistance or customer product design. Customers are responsible for their products and applications using TI components. To minimize the risks associated with customer products and applications, customers should provide adequate design and operating safeguards.

TI does not warrant or represent that any license, either express or implied, is granted under any TI patent right, copyright, mask work right, or other TI intellectual property right relating to any combination, machine, or process in which TI products or services are used. Information published by TI regarding third-party products or services does not constitute a license from TI to use such products or services or a warranty or endorsement thereof. Use of such information may require a license from a third party under the patents or other intellectual property of the third party, or a license from TI under the patents or other intellectual property of TI.

Reproduction of TI information in TI data books or data sheets is permissible only if reproduction is without alteration and is accompanied by all associated warranties, conditions, limitations, and notices. Reproduction of this information with alteration is an unfair and deceptive business practice. TI is not responsible or liable for such altered documentation. Information of third parties may be subject to additional restrictions.

Resale of TI products or services with statements different from or beyond the parameters stated by TI for that product or service voids all express and any implied warranties for the associated TI product or service and is an unfair and deceptive business practice. TI is not responsible or liable for any such statements.

TI products are not authorized for use in safety-critical applications (such as life support) where a failure of the TI product would reasonably be expected to cause severe personal injury or death, unless officers of the parties have executed an agreement specifically governing such use. Buyers represent that they have all necessary expertise in the safety and regulatory ramifications of their applications, and acknowledge and agree that they are solely responsible for all legal, regulatory and safety-related requirements concerning their products and any use of TI products in such safety-critical applications, notwithstanding any applications-related information or support that may be provided by TI. Further, Buyers must fully indemnify TI and its representatives against any damages arising out of the use of TI products in such safety-critical applications.

TI products are neither designed nor intended for use in military/aerospace applications or environments unless the TI products are specifically designated by TI as military-grade or "enhanced plastic." Only products designated by TI as military-grade meet military specifications. Buyers acknowledge and agree that any such use of TI products which TI has not designated as military-grade is solely at the Buyer's risk, and that they are solely responsible for compliance with all legal and regulatory requirements in connection with such use.

TI products are neither designed nor intended for use in automotive applications or environments unless the specific TI products are designated by TI as compliant with ISO/TS 16949 requirements. Buyers acknowledge and agree that, if they use any non-designated products in automotive applications, TI will not be responsible for any failure to meet such requirements.

Following are URLs where you can obtain information on other Texas Instruments products and application solutions:

Products

Audio	www.ti.com/audio
Amplifiers	amplifier.ti.com
Data Converters	dataconverter.ti.com
DLP® Products	www.dlp.com
DSP	dsp.ti.com
Clocks and Timers	www.ti.com/clocks
Interface	interface.ti.com
Logic	logic.ti.com
Power Mgmt	power.ti.com
Microcontrollers	microcontroller.ti.com
RFID	www.ti-rfid.com
OMAP Mobile Processors	www.ti.com/omap
Wireless Connectivity	www.ti.com/wirelessconnectivity

Applications

Automotive and Transportation	www.ti.com/automotive
Communications and Telecom	www.ti.com/communications
Computers and Peripherals	www.ti.com/computers
Consumer Electronics	www.ti.com/consumer-apps
Energy and Lighting	www.ti.com/energy
Industrial	www.ti.com/industrial
Medical	www.ti.com/medical
Security	www.ti.com/security
Space, Avionics and Defense	www.ti.com/space-avionics-defense
Video and Imaging	www.ti.com/video

TI E2E Community Home Page

e2e.ti.com

Mailing Address: Texas Instruments, Post Office Box 655303, Dallas, Texas 75265
Copyright © 2012, Texas Instruments Incorporated

Looking for pricing, stock, or lifecycle information?

Click below to explore more details on WIN SOURCE:

 [View CSD75205W1015](#) on WIN SOURCE

 [Texas Instruments](#) Information

Optimize Your Supply Chain with WIN SOURCE Solutions

-  Global Sourcing Solution
-  Obsolete Management
-  Cost Control Management
-  Shortage Management
-  Alternative Solution
-  Excess Inventory Management