



# THE DATASHEET OF STFI9N80K5



## N-channel 800 V, 0.73 $\Omega$ typ., 7 A MDmesh™ K5 Power MOSFETs in TO-220FP and I<sup>2</sup>PAKFP packages

Datasheet - production data

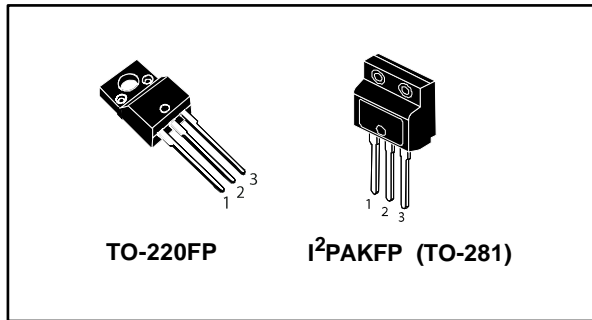
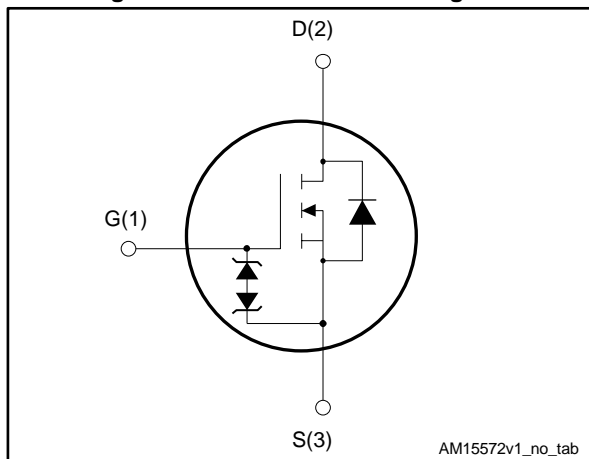

Figure 1: Internal schematic diagram



### Features

Order code	V <sub>DS</sub>	R <sub>DS(on)</sub> max.	I <sub>D</sub>
STF9N80K5	800 V	0.90 $\Omega$	7 A
STFI9N80K5			

- Industry's lowest R<sub>DS(on)</sub> x area
- Industry's best figure of merit (FoM)
- Ultra-low gate charge
- 100% avalanche tested
- Zener-protected

### Applications

- Switching applications

### Description

This very high voltage N-channel Power MOSFET is designed using MDmesh™ K5 technology based on an innovative proprietary vertical structure. The result is a dramatic reduction in on-resistance and ultra-low gate charge for applications requiring superior power density and high efficiency.

Table 1: Device summary

Order code	Marking	Package	Packing
STF9N80K5	9N80K5	TO-220FP	Tube
STFI9N80K5		I <sup>2</sup> PAKFP(TO-281)	

---

# Contents

- 1 Electrical ratings ..... 3**
- 2 Electrical characteristics ..... 4**
  - 2.1 Electrical characteristics (curves) ..... 6
- 3 Test circuits ..... 9**
- 4 Package information ..... 10**
  - 4.1 TO-220FP package information ..... 11
  - 4.2 I2PAKFP (TO-281) package information..... 13
- 5 Revision history ..... 15**



# 1 Electrical ratings

**Table 2: Absolute maximum ratings**

Symbol	Parameter	Value	Unit
$V_{GS}$	Gate-source voltage	$\pm 30$	V
$I_D^{(1)}$	Drain current (continuous) at $T_C = 25\text{ }^\circ\text{C}$	7	A
$I_D^{(1)}$	Drain current (continuous) at $T_C = 100\text{ }^\circ\text{C}$	4.4	A
$I_D^{(2)}$	Drain current (pulsed)	28	A
$P_{TOT}$	Total dissipation at $T_C = 25\text{ }^\circ\text{C}$	25	W
$V_{ISO}$	Insulation withstand voltage (RMS) from all three leads to external heat sink ( $t=1\text{ s}$ ; $T_C=25\text{ }^\circ\text{C}$ )	2500	V
$dv/dt^{(3)}$	Peak diode recovery voltage slope	4.5	V/ns
$dv/dt^{(4)}$	MOSFET $dv/dt$ ruggedness	50	
$T_{stg}$	Storage temperature	- 55 to 150	$^\circ\text{C}$
$T_J$	Operating junction temperature		

**Notes:**

<sup>(1)</sup>Limited by maximum junction temperature.

<sup>(2)</sup>Pulse width limited by safe operating area

<sup>(3)</sup> $I_{SD} \leq 7\text{ A}$ ,  $di/dt \leq 100\text{ A}/\mu\text{s}$ ;  $V_{DS\text{ peak}} < V_{(BR)DSS}$ ,  $V_{DD} = 640\text{ V}$

<sup>(4)</sup> $V_{DS} \leq 640\text{ V}$

**Table 3: Thermal data**

Symbol	Parameter	Value	Unit
$R_{thj-case}$	Thermal resistance junction-case	5	$^\circ\text{C}/\text{W}$
$R_{thj-amb}$	Thermal resistance junction-ambient	62.5	$^\circ\text{C}/\text{W}$

**Table 4: Avalanche characteristics**

Symbol	Parameter	Value	Unit
$I_{AR}$	Avalanche current, repetitive or not repetitive (pulse width limited by $T_{jmax}$ )	2.4	A
$E_{AR}$	Single pulse avalanche energy (starting $T_j = 25\text{ }^\circ\text{C}$ , $I_D = I_{AR}$ , $V_{DD} = 50\text{ V}$ )	200	mJ

## 2 Electrical characteristics

$T_C = 25\text{ °C}$  unless otherwise specified

**Table 5: On/off-state**

Symbol	Parameter	Test conditions	Min.	Typ.	Max.	Unit
$V_{(BR)DSS}$	Drain-source breakdown voltage	$V_{GS} = 0\text{ V}$ , $I_D = 1\text{ mA}$	800			V
$I_{DSS}$	Zero gate voltage drain current	$V_{GS} = 0\text{ V}$ , $V_{DS} = 800\text{ V}$			1	$\mu\text{A}$
		$V_{GS} = 0\text{ V}$ , $V_{DS} = 800\text{ V}$ $T_C = 125\text{ °C}$			50	$\mu\text{A}$
$I_{GSS}$	Gate body leakage current	$V_{DS} = 0\text{ V}$ , $V_{GS} = \pm 20\text{ V}$			$\pm 10$	$\mu\text{A}$
$V_{GS(th)}$	Gate threshold voltage	$V_{DS} = V_{GS}$ , $I_D = 100\text{ }\mu\text{A}$	3	4	5	V
$R_{DS(on)}$	Static drain-source on-resistance	$V_{GS} = 10\text{ V}$ , $I_D = 3.5\text{ A}$		0.73	0.90	$\Omega$

**Table 6: Dynamic**

Symbol	Parameter	Test conditions	Min.	Typ.	Max.	Unit
$C_{iss}$	Input capacitance	$V_{DS} = 100\text{ V}$ , $f = 1\text{ MHz}$ , $V_{GS} = 0\text{ V}$	-	340	-	pF
$C_{oss}$	Output capacitance		-	37	-	pF
$C_{rss}$	Reverse transfer capacitance		-	0.65	-	pF
$C_{o(tr)}^{(1)}$	Equivalent capacitance time related	$V_{DS} = 0\text{ to }640\text{ V}$ , $V_{GS} = 0\text{ V}$	-	61	-	pF
$C_{o(er)}^{(2)}$	Equivalent capacitance energy related		-	22	-	pF
$R_g$	Intrinsic gate resistance	$f = 1\text{ MHz}$ , $I_D = 0\text{ A}$	-	7	-	$\Omega$
$Q_g$	Total gate charge	$V_{DD} = 640\text{ V}$ , $I_D = 7\text{ A}$ $V_{GS} = 10\text{ V}$ See (Figure 16: "Test circuit for gate charge behavior")	-	12	-	nC
$Q_{gs}$	Gate-source charge		-	3.8	-	nC
$Q_{gd}$	Gate-drain charge		-	6.7	-	nC

**Notes:**

<sup>(1)</sup>Time related is defined as a constant equivalent capacitance giving the same charging time as  $C_{oss}$  when  $V_{DS}$  increases from 0 to 80%  $V_{DSS}$

<sup>(2)</sup>Energy related is defined as a constant equivalent capacitance giving the same stored energy as  $C_{oss}$  when  $V_{DS}$  increases from 0 to 80%  $V_{DSS}$

**Table 7: Switching times**

Symbol	Parameter	Test conditions	Min.	Typ.	Max.	Unit
$t_{d(on)}$	Turn-on delay time	$V_{DD} = 400\text{ V}$ , $I_D = 3.5\text{ A}$ , $R_G = 4.7\text{ }\Omega$ , $V_{GS} = 10\text{ V}$ See (Figure 15: "Test circuit for resistive load switching times" and Figure 20: "Switching time waveform")	-	11	-	ns
$t_r$	Rise time		-	5.7	-	ns
$t_{d(off)}$	Turn-off delay time		-	65.3	-	ns
$t_f$	Fall time		-	13.6	-	ns

Table 8: Source-drain diode

Symbol	Parameter	Test conditions	Min.	Typ.	Max.	Unit
$I_{SD}$	Source-drain current		-		7	A
$I_{SDM}^{(1)}$	Source-drain current (pulsed)		-		28	A
$V_{SD}^{(2)}$	Forward on voltage	$I_{SD} = 7 \text{ A}$ , $V_{GS} = 0 \text{ V}$	-		1.5	V
$T_{rr}$	Reverse recovery time	$I_{SD} = 7 \text{ A}$ , $di/dt = 100 \text{ A}/\mu\text{s}$ , $V_{DD} = 60 \text{ V}$ See <i>Figure 17: "Test circuit for inductive load switching and diode recovery times"</i>	-	292		ns
$Q_{rr}$	Reverse recovery charge		-	2.66		$\mu\text{C}$
$I_{RRM}$	Reverse recovery current		-	18.2		A
$T_{rr}$	Reverse recovery time	$I_{SD} = 7 \text{ A}$ , $di/dt = 100 \text{ A}/\mu\text{s}$ , $V_{DD} = 60 \text{ V}$ , $T_j = 150 \text{ }^\circ\text{C}$ See <i>Figure 17: "Test circuit for inductive load switching and diode recovery times"</i>	-	477		ns
$Q_{rr}$	Reverse recovery charge		-	3.91		$\mu\text{C}$
$I_{RRM}$	Reverse recovery current		-	16.4		A

**Notes:**

<sup>(1)</sup>Pulse width limited by safe operating area

<sup>(2)</sup>Pulsed: pulse duration = 300  $\mu\text{s}$ , duty cycle 1.5%

Table 9: Gate-source Zener diode

Symbol	Parameter	Test conditions	Min.	Typ.	Max.	Unit
$V_{(BR)GSO}$	Gate-source breakdown voltage	$I_{GS} = \pm 1 \text{ mA}$ , $I_D = 0 \text{ A}$	30	-	-	V

The built-in back-to-back Zener diodes are specifically designed to enhance the ESD performance of the device. The Zener voltage facilitates efficient and cost-effective device integrity protection, thus eliminating the need for additional external componentry.

## 2.2 Electrical characteristics (curves)

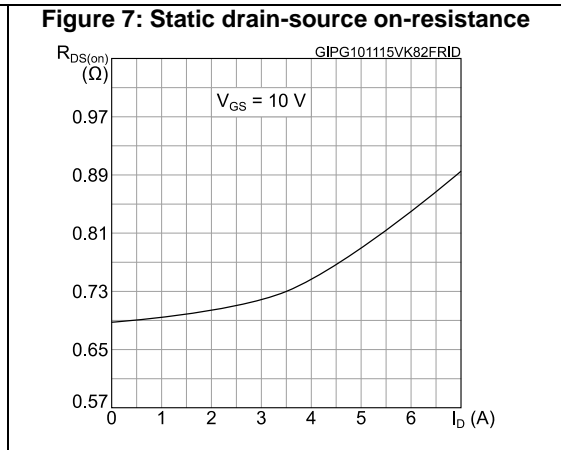
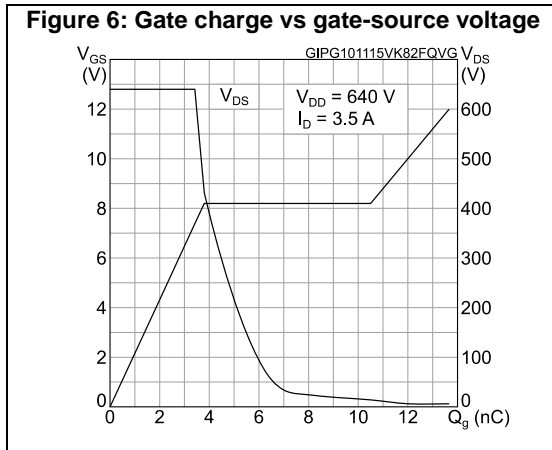
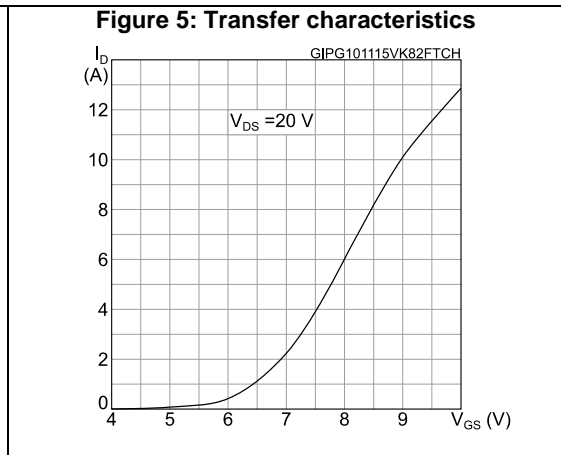
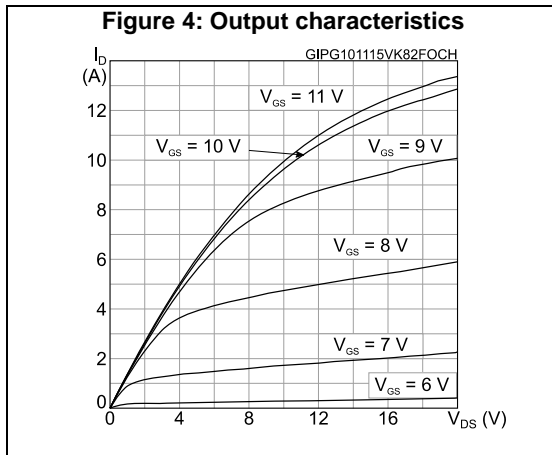
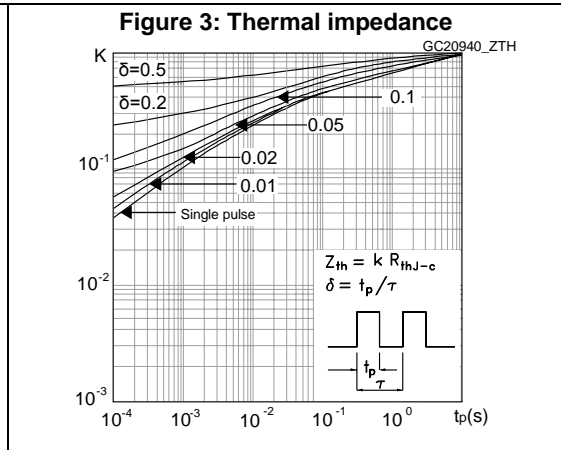
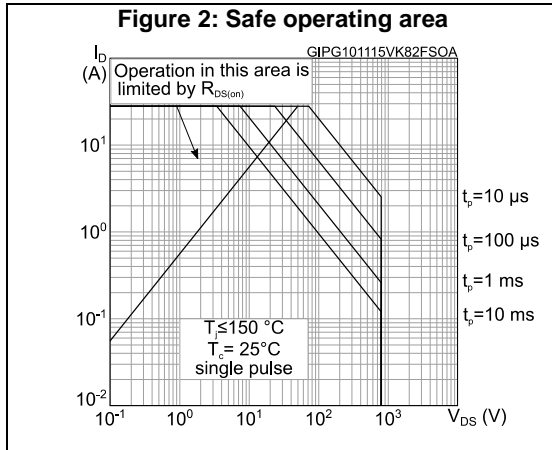

Figure 8: Capacitance variations

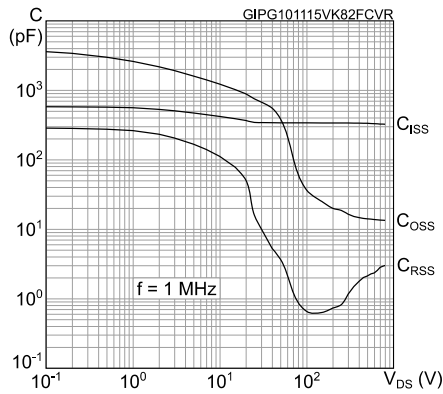

Figure 9: Normalized gate threshold voltage vs temperature

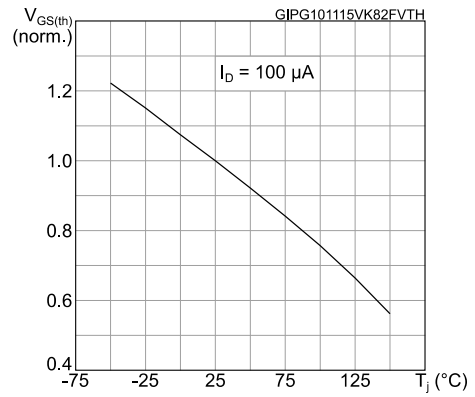

Figure 10: Normalized on-resistance vs temperature

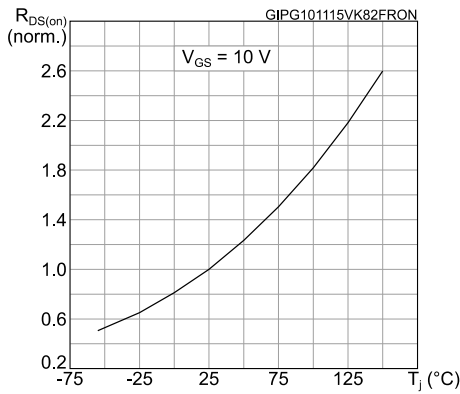

Figure 11: Normalized V<sub>(BR)DSS</sub> vs temperature

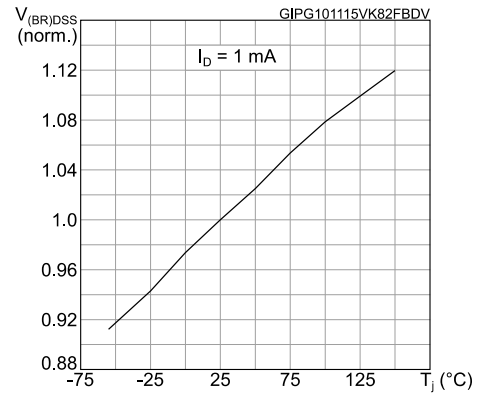

Figure 12: Output capacitance stored energy

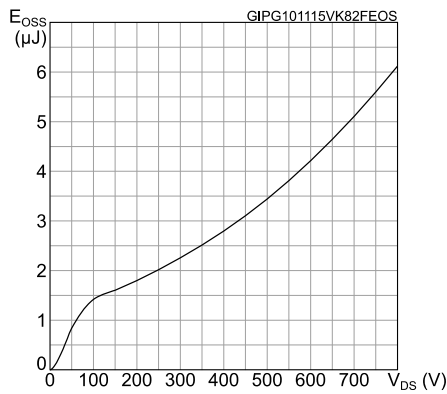

Figure 13: Source-drain diode forward characteristics

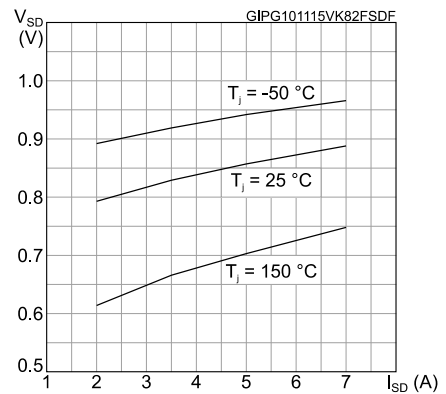
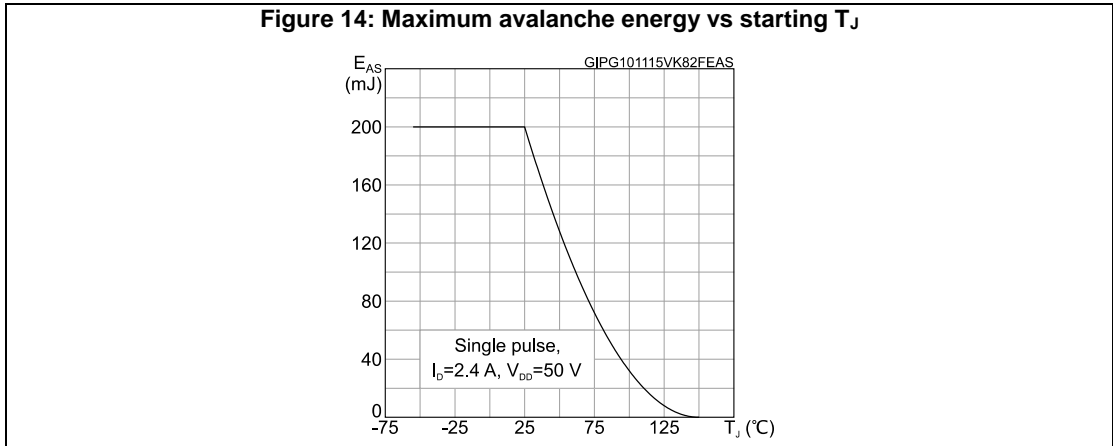
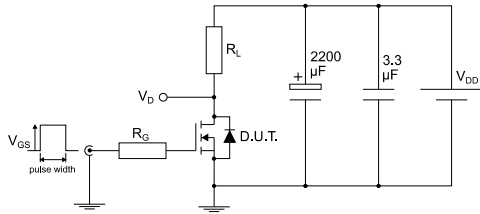

Figure 14: Maximum avalanche energy vs starting  $T_J$



### 3 Test circuits

**Figure 15: Test circuit for resistive load switching times**



AM01468v1

**Figure 16: Test circuit for gate charge behavior**

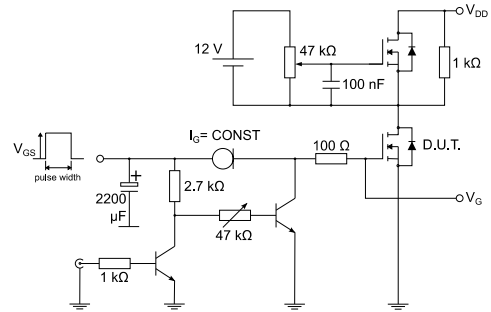

AM01469v1

**Figure 17: Test circuit for inductive load switching and diode recovery times**

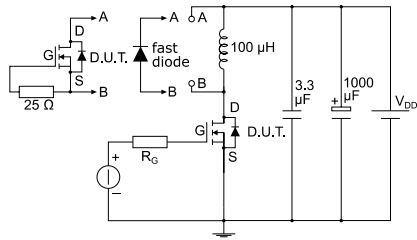

AM01470v1

**Figure 18: Unclamped inductive load test circuit**

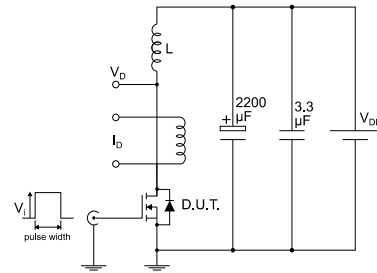

AM01471v1

**Figure 19: Unclamped inductive waveform**

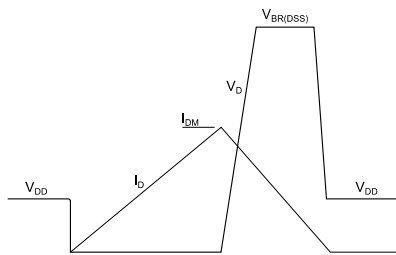

AM01472v1

**Figure 20: Switching time waveform**

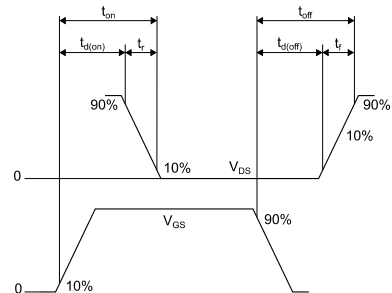

AM01473v1

## 4 Package information

In order to meet environmental requirements, ST offers these devices in different grades of ECOPACK<sup>®</sup> packages, depending on their level of environmental compliance. ECOPACK<sup>®</sup> specifications, grade definitions and product status are available at: [www.st.com](http://www.st.com). ECOPACK<sup>®</sup> is an ST trademark.

### 4.1 TO-220FP package information

Figure 21: TO-220FP package outline

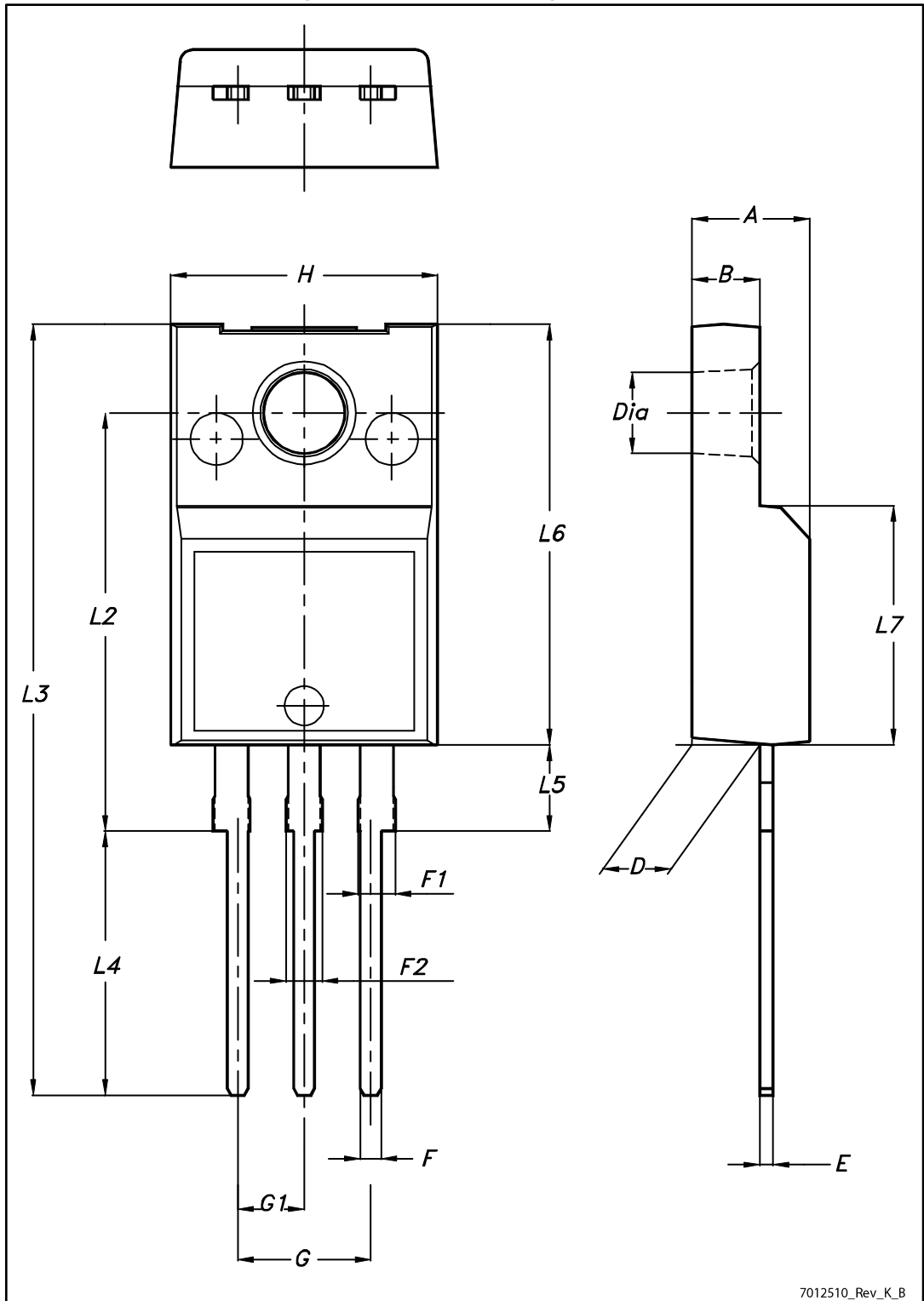

7012510\_Rev\_K\_B

Table 10: TO-220FP package mechanical data

Dim.	mm		
	Min.	Typ.	Max.
A	4.4		4.6
B	2.5		2.7
D	2.5		2.75
E	0.45		0.7
F	0.75		1
F1	1.15		1.70
F2	1.15		1.70
G	4.95		5.2
G1	2.4		2.7
H	10		10.4
L2		16	
L3	28.6		30.6
L4	9.8		10.6
L5	2.9		3.6
L6	15.9		16.4
L7	9		9.3
Dia	3		3.2

### 4.2 I<sup>2</sup>PAKFP (TO-281) package information

Figure 22: I<sup>2</sup>PAKFP (TO-281) package outline

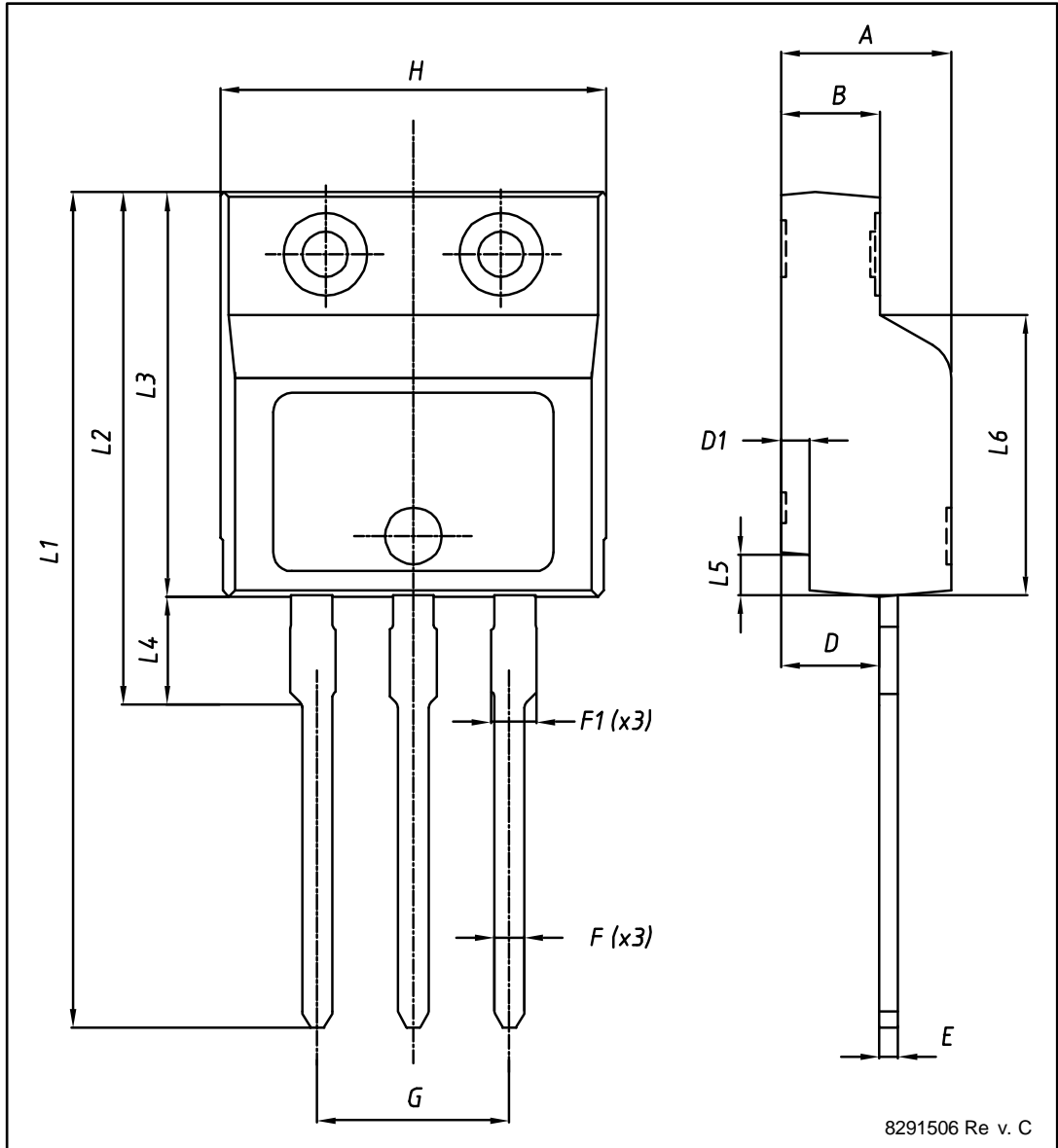

8291506 Re v. C

Table 11: I<sup>2</sup>PAKFP (TO-281) mechanical data

Dim.	mm		
	Min.	Typ.	Max.
A	4.40		4.60
B	2.50		2.70
D	2.50		2.75
D1	0.65		0.85
E	0.45		0.70
F	0.75		1.00
F1			1.20
G	4.95		5.20
H	10.00		10.40
L1	21.00		23.00
L2	13.20		14.10
L3	10.55		10.85
L4	2.70		3.20
L5	0.85		1.25
L6	7.50	7.60	7.70

## 5 Revision history

**Table 12: Document revision history**

Date	Revision	Changes
06-Oct-2015	1	First release.
11-Nov-2015	2	Modified: <i>Table 2: "Absolute maximum ratings"</i> , <i>Table 3: "Thermal data"</i> , <i>Table 4: "Avalanche characteristics"</i> , <i>Table 6: "Dynamic"</i> , <i>Table 7: "Switching times"</i> and <i>Table 8: "Source-drain diode"</i> . Added: <i>Section 3.1: "Electrical characteristics (curves)"</i> Minor text changes

**IMPORTANT NOTICE – PLEASE READ CAREFULLY**

STMicroelectronics NV and its subsidiaries ("ST") reserve the right to make changes, corrections, enhancements, modifications, and improvements to ST products and/or to this document at any time without notice. Purchasers should obtain the latest relevant information on ST products before placing orders. ST products are sold pursuant to ST's terms and conditions of sale in place at the time of order acknowledgement.

Purchasers are solely responsible for the choice, selection, and use of ST products and ST assumes no liability for application assistance or the design of Purchasers' products.

No license, express or implied, to any intellectual property right is granted by ST herein.

Resale of ST products with provisions different from the information set forth herein shall void any warranty granted by ST for such product.



ST and the ST logo are trademarks of ST. All other product or service names are the property of their respective owners.

Information in this document supersedes and replaces information previously supplied in any prior versions of this document.

© 2015 STMicroelectronics – All rights reserved

## Looking for pricing, stock, or lifecycle information?

Click below to explore more details on WIN SOURCE:

-  [View STFI9N80K5 on WIN SOURCE](#)
-  [STMicroelectronics Information](#)

## Optimize Your Supply Chain with WIN SOURCE Solutions

-  Global Sourcing Solution
-  Obsolete Management
-  Cost Control Management
-  Shortage Management
-  Alternative Solution
-  Excess Inventory Management