



**THE DATASHEET OF
NTBLS4D0N15MC**



MOSFET – Single N-Channel

150 V, 4.4 mΩ, 187 A

NTBLS4D0N15MC

Features

- Low $R_{DS(on)}$ to Minimize Conduction Losses
- Low Q_G and Capacitance to Minimize Driver Losses
- Lowers Switching Noise/EMI
- These Devices are Pb-Free, Halogen Free/BFR Free and are RoHS Compliant

Typical Applications

- Power Tools, Battery Operated Vacuums
- UAV/Drones, Material Handling
- BMS/Storage, Home Automation

MAXIMUM RATINGS ($T_J = 25^\circ\text{C}$ unless otherwise noted)

Symbol	Parameter			Value	Unit
V_{DSS}	Drain-to-Source Voltage			150	V
V_{GS}	Gate-to-Source Voltage			± 20	V
I_D	Continuous Drain Current $R_{\theta JC}$ (Note 2)	Steady State	$T_C = 25^\circ\text{C}$	187	A
P_D				Power Dissipation $R_{\theta JC}$ (Note 2)	316
I_D	Continuous Drain Current $R_{\theta JA}$ (Notes 1, 2)	Steady State	$T_A = 25^\circ\text{C}$	19	A
P_D				Power Dissipation $R_{\theta JA}$ (Notes 1, 2)	3.4
I_{DM}	Pulsed Drain Current	$T_A = 25^\circ\text{C}, t_p = 10 \mu\text{s}$	2255	A	
T_J, T_{stg}	Operating Junction and Storage Temperature Range			-55 to 175	$^\circ\text{C}$
I_S	Source Current (Body Diode)			263	A
E_{AS}	Single Pulse Drain-to-Source Avalanche Energy ($I_L = 81.5 \text{ A}_{pk}, L = 0.1 \text{ mH}$)			332	mJ
T_L	Lead Temperature Soldering Reflow for Soldering Purposes (1/8" from case for 10 s)			260	$^\circ\text{C}$

Stresses exceeding those listed in the Maximum Ratings table may damage the device. If any of these limits are exceeded, device functionality should not be assumed, damage may occur and reliability may be affected.

1. Surface-mounted on FR4 board using 1 in² pad size, 1 oz Cu pad.
2. The entire application environment impacts the thermal resistance values shown, they are not constants and are only valid for the particular conditions noted.



ON Semiconductor®

www.onsemi.com

$V_{(BR)DSS}$	$R_{DS(ON)} \text{ MAX}$	$I_D \text{ MAX}$
150 V	4.4 mΩ @ 10 V	187 A
	4.9 mΩ @ 8 V	

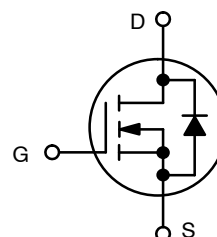

N-CHANNEL MOSFET

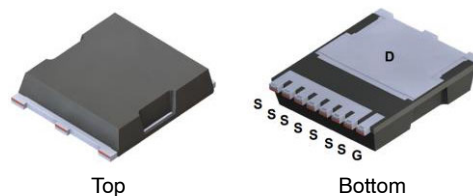

Top Bottom

H-PSOF8L 11.68x9.80
MO-299A
CASE 100CU

MARKING DIAGRAM

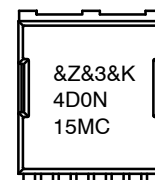

&Z = Assembly Plant Code
&3 = Numeric Date Code
&K = Lot Code
4D0N15MC = Specific Device Code

ORDERING INFORMATION

Device	Package	Shipping†
NTBLS4D0N15MC	MO-299A (Pb-Free)	2000 / Tape & Reel

†For information on tape and reel specifications, including part orientation and tape sizes, please refer to our Tape and Reel Packaging Specifications Brochure, BRD8011/D.

NTBLS4D0N15MC

THERMAL RESISTANCE RATINGS

Symbol	Parameter	Max	Unit
$R_{\theta JC}$	Junction-to-Case – Steady State (Note 2)	0.5	°C/W
$R_{\theta JA}$	Junction-to-Ambient – Steady State (Note 2)	43	

ELECTRICAL CHARACTERISTICS ($T_J = 25^\circ\text{C}$ unless otherwise noted)

Symbol	Parameter	Test Condition	Min	Typ	Max	Unit
--------	-----------	----------------	-----	-----	-----	------

OFF CHARACTERISTICS

$V_{(BR)DSS}$	Drain-to-Source Breakdown Voltage	$V_{GS} = 0\text{ V}, I_D = 250\ \mu\text{A}$	150	–	–	V	
$V_{(BR)DSS} / T_J$	Drain-to-Source Breakdown Voltage Temperature Coefficient	$I_D = 250\ \mu\text{A}$, ref to 25°C	–	30.23	–	mV/°C	
I_{DSS}	Zero Gate Voltage Drain Current	$V_{GS} = 0\text{ V}, V_{DS} = 120\text{ V}$	$T_J = 25^\circ\text{C}$	–	–	1	μA
			$T_J = 125^\circ\text{C}$	–	–	10	μA
I_{GSS}	Gate-to-Source Leakage Current	$V_{DS} = 0\text{ V}, V_{GS} = \pm 20\text{ V}$	–	–	± 100	nA	

ON CHARACTERISTICS

$V_{GS(TH)}$	Gate Threshold Voltage	$V_{GS} = V_{DS}, I_D = 584\ \mu\text{A}$	2.5	3.7	4.5	V
$V_{GS(TH)} / T_J$	Negative Threshold Temperature Coefficient	$I_D = 250\ \mu\text{A}$, ref to 25°C	–	–10.12	–	mV/°C
$R_{DS(on)}$	Drain-to-Source On Resistance	$V_{GS} = 10\text{ V}, I_D = 80\text{ A}$	–	3.1	4.4	m Ω
		$V_{GS} = 8\text{ V}, I_D = 53\text{ A}$	–	3.5	4.9	
g_{FS}	Forward Transconductance	$V_{DS} = 5\text{ V}, I_D = 80\text{ A}$	–	174	–	S
R_G	Gate-Resistance	$T_A = 25^\circ\text{C}$	–	1.3	–	Ω

CHARGES & CAPACITANCES

C_{ISS}	Input Capacitance	$V_{GS} = 0\text{ V}, f = 1\text{ MHz}, V_{DS} = 75\text{ V}$	–	7490	–	pF
C_{OSS}	Output Capacitance		–	2055	–	
C_{RSS}	Reverse Transfer Capacitance		–	27.2	–	
$Q_{G(TOT)}$	Total Gate Charge	$V_{GS} = 10\text{ V}, V_{DS} = 75\text{ V}, I_D = 80\text{ A}$	–	90.4	–	nC
$Q_{G(TH)}$	Threshold Gate Charge		–	24.7	–	
Q_{GS}	Gate-to-Source Charge		–	40.2	–	
Q_{GD}	Gate-to-Drain Charge		–	12.6	–	
V_{GP}	Plateau Voltage		–	5.7	–	
Q_{OSS}	Output Charge	$V_{GS} = 0\text{ V}, V_{DS} = 75\text{ V}$	–	251	–	nC

SWITCHING CHARACTERISTICS, $V_{GS} = 10\text{ V}$ (Note 3)

$t_{d(ON)}$	Turn-On Delay Time	$V_{GS} = 10\text{ V}, V_{DS} = 75\text{ V}, I_D = 80\text{ A}, R_G = 6\ \Omega$	–	47	–	ns
t_r	Rise Time		–	115	–	
$t_{d(OFF)}$	Turn-Off Delay Time		–	58	–	
t_f	Fall Time		–	11	–	

DRAIN-SOURCE DIODE CHARACTERISTICS

V_{SD}	Forward Diode Voltage	$V_{GS} = 0\text{ V}, I_S = 80\text{ A}$	$T_J = 25^\circ\text{C}$	–	0.86	1.2	V
			$T_J = 125^\circ\text{C}$	–	0.75	–	

NTBLS4D0N15MC

ELECTRICAL CHARACTERISTICS ($T_J = 25^\circ\text{C}$ unless otherwise noted) (continued)

Symbol	Parameter	Test Condition	Min	Typ	Max	Unit
t_{RR}	Reverse Recovery Time	$V_{GS} = 0\text{ V}$, $di_S/dt = 100\text{ A}/\mu\text{s}$, $I_S = 80\text{ A}$	–	84	–	ns
t_a	Charge Time		–	55	–	
t_b	Discharge Time		–	29	–	
Q_{RR}	Reverse Recovery Charge		–	180	–	nC

Product parametric performance is indicated in the Electrical Characteristics for the listed test conditions, unless otherwise noted. Product performance may not be indicated by the Electrical Characteristics if operated under different conditions.

3. Switching characteristics are independent of operating junction temperatures

NTBLS4D0N15MC

TYPICAL CHARACTERISTICS

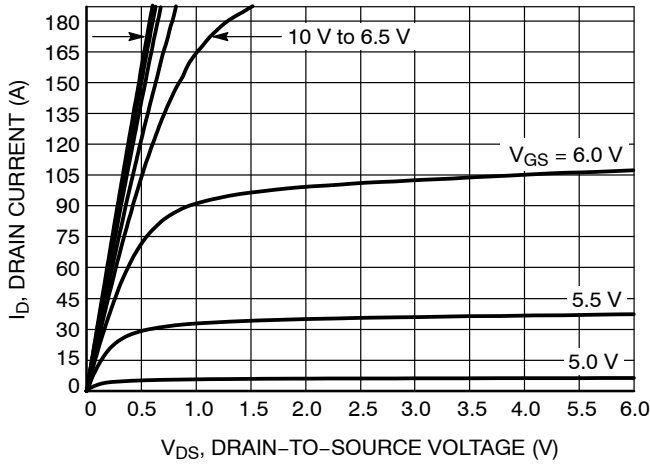

Figure 1. On-Region Characteristics

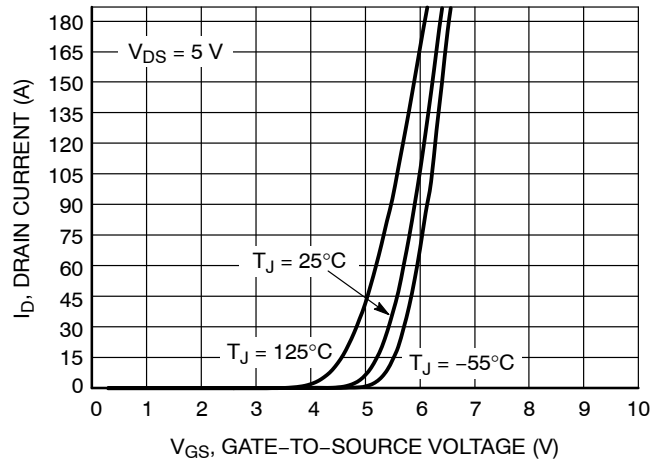

Figure 2. Transfer Characteristics

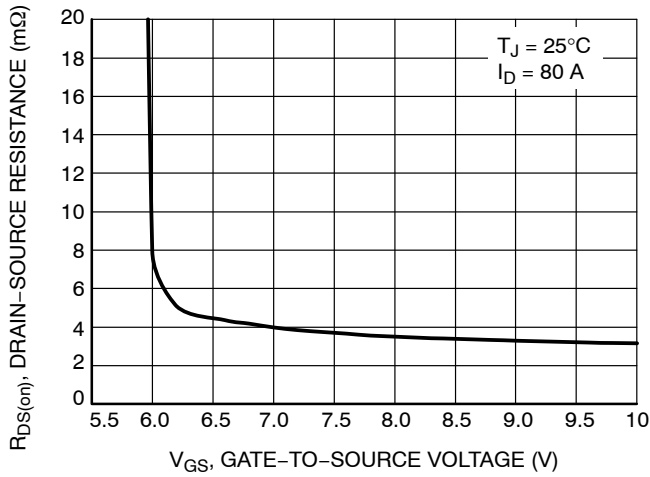

Figure 3. On-Resistance vs. V_{GS}

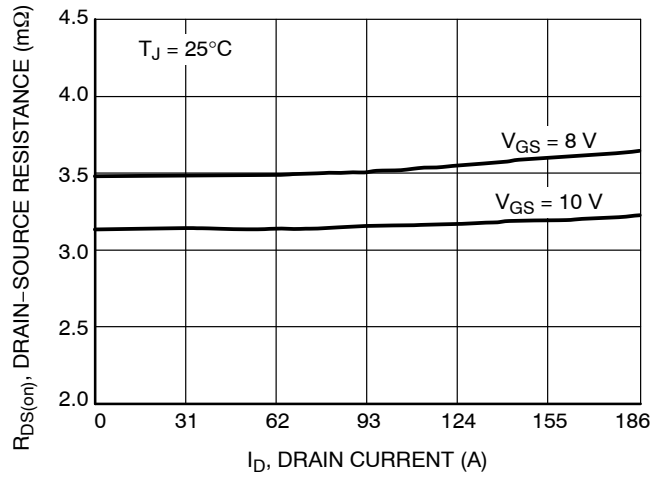

Figure 4. On-Resistance vs. Drain Current and Gate Voltage

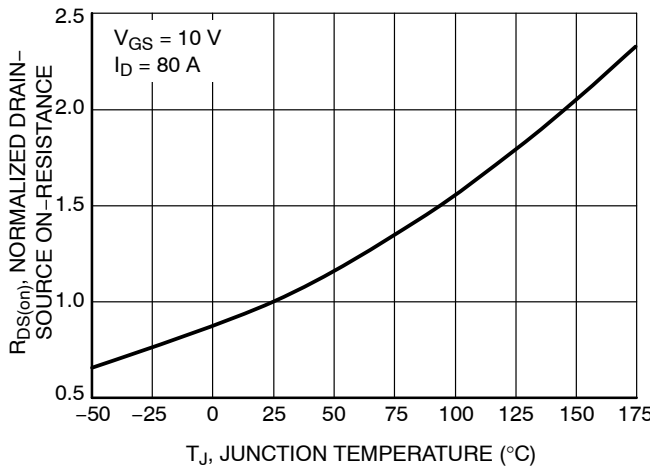

Figure 5. On-Resistance Variation with Temperature

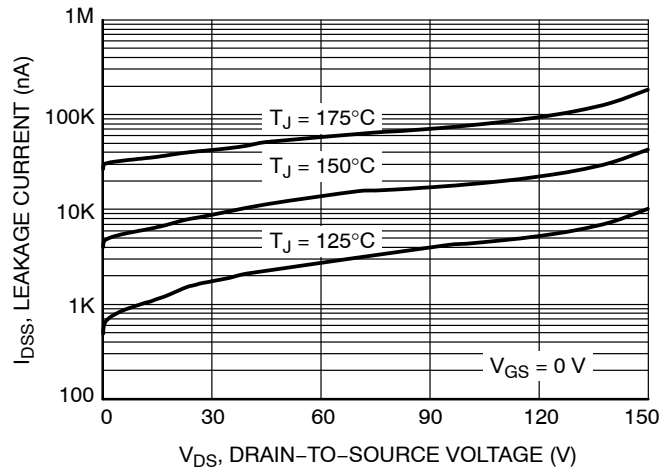

Figure 6. Drain-to-Source Leakage Current vs. Voltage

NTBLS4D0N15MC

TYPICAL CHARACTERISTICS

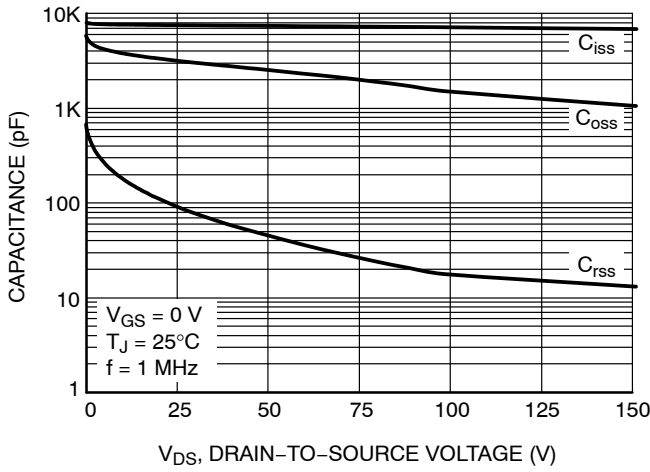

Figure 7. Capacitance Variation

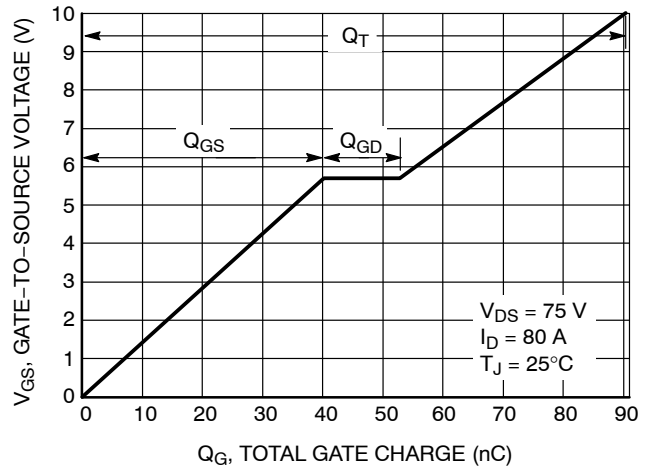

Figure 8. Gate-to-Source Voltage vs. Total Gate Charge

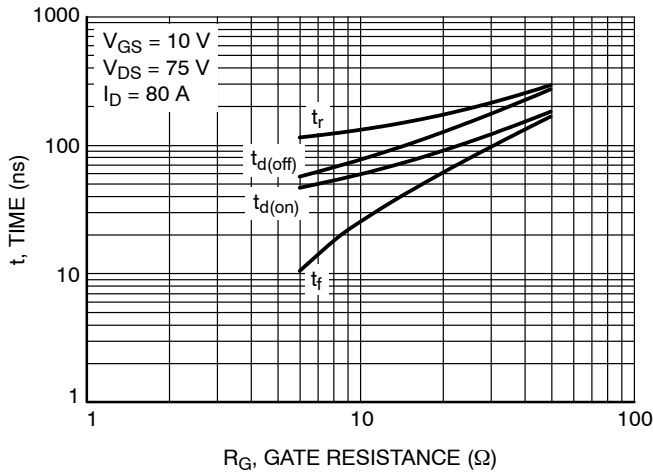

Figure 9. Resistive Switching Time Variation vs. Gate Resistance

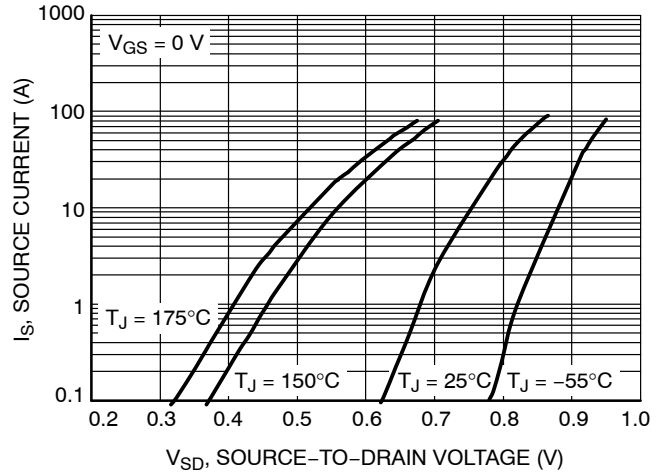

Figure 10. Diode Forward Voltage vs. Current

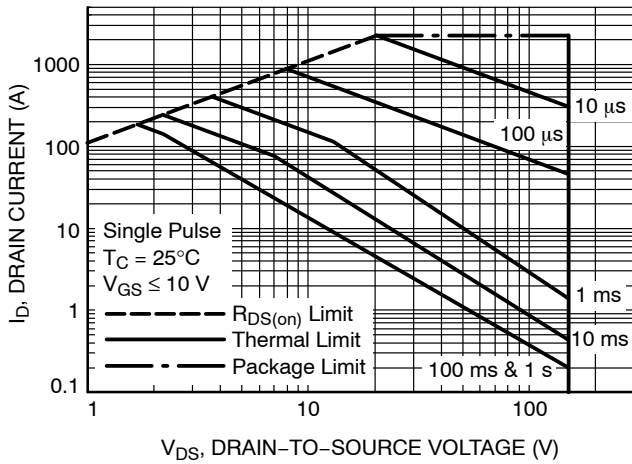

Figure 11. Maximum Rated Forward Biased Safe Operating Area

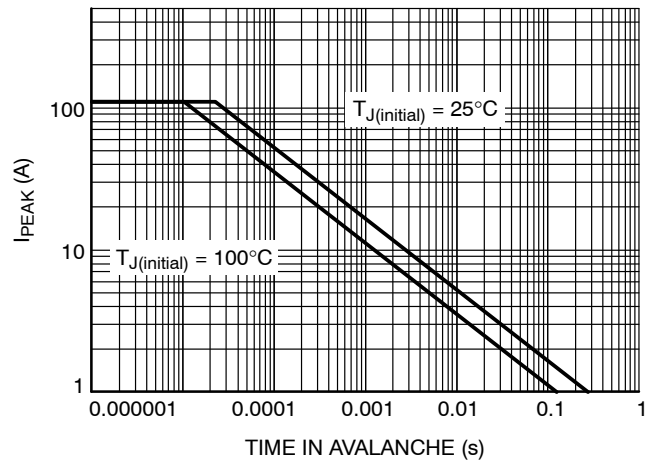

Figure 12. I_{PEAK} vs. Time in Avalanche

NTBLS4D0N15MC

TYPICAL CHARACTERISTICS

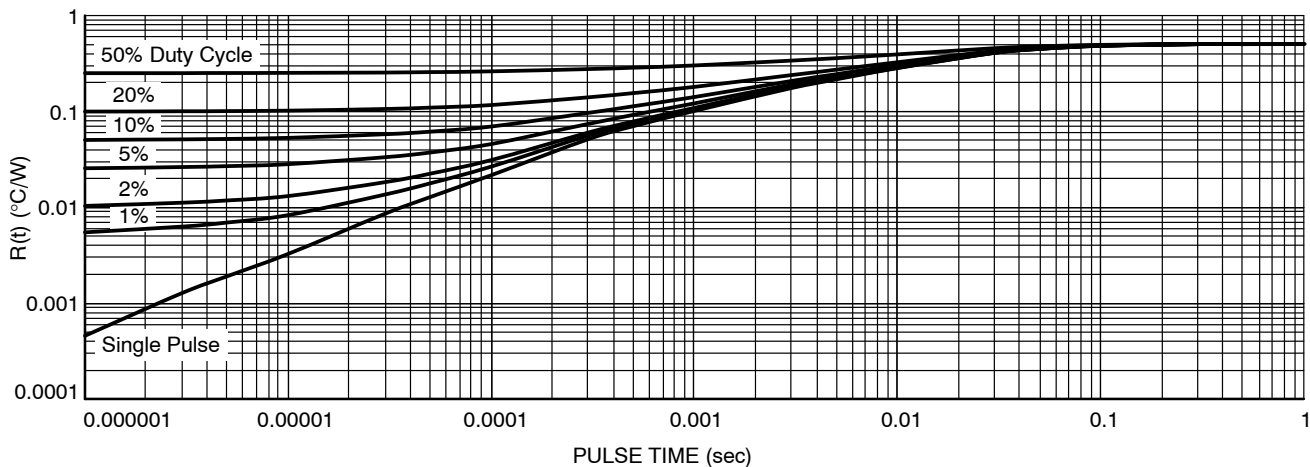
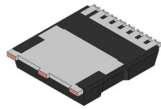

Figure 13. Thermal Characteristics (Junction-to-Ambient)

MECHANICAL CASE OUTLINE PACKAGE DIMENSIONS



H-PSOF8L 11.68x9.80x2.30, 1.20P
CASE 100CU
ISSUE E

DATE 31 MAY 2024

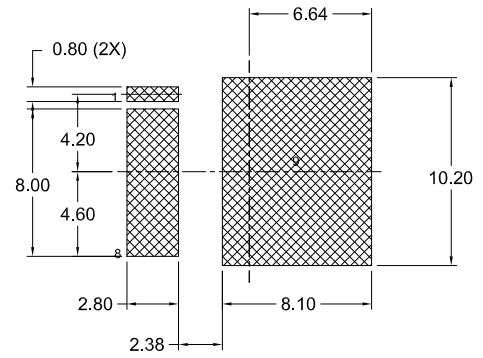
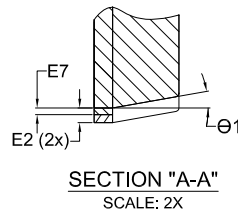
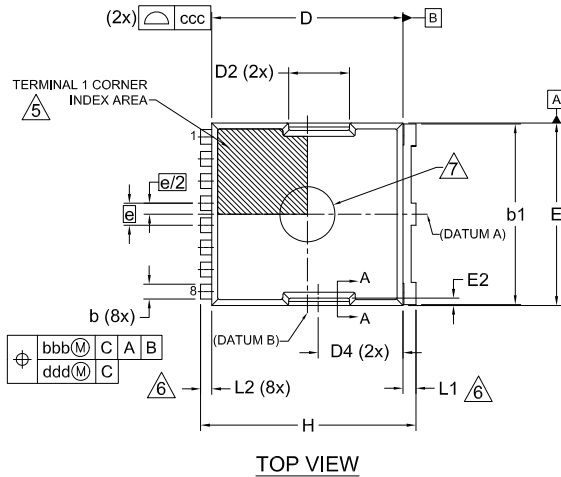

*FOR ADDITIONAL INFORMATION ON OUR PB-FREE STRATEGY AND SOLDERING DETAILS, PLEASE DOWNLOAD THE ONSEMI SOLDERING AND MOUNTING TECHNIQUES REFERENCE MANUAL, SOLDERRM/D.

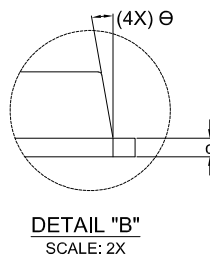
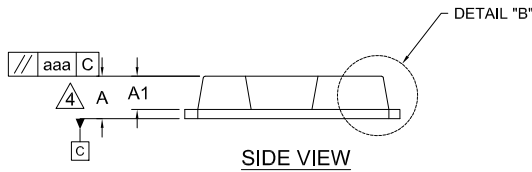

- NOTES:**
1. PACKAGE STANDARD REFERENCE: JEDEC MO-299, ISSUE B.
 2. DIMENSIONING AND TOLERANCING PER ASME Y14.5M, 2018.
 3. "e" REPRESENTS THE TERMINAL PITCH.
 4. THIS DIMENSION INCLUDES ENCAPSULATION THICKNESS "A1", AND PACKAGE BODY THICKNESS, BUT DOES NOT INCLUDE ATTACHED FEATURES, e.g., EXTERNAL OR CHIP CAPACITORS. AN INTEGRAL HEATSLUG IS NOT CONSIDERED AS ATTACHED FEATURE.
 5. A VISUAL INDEX FEATURE MUST BE LOCATED WITHIN THE HATCHED AREA.
 6. DIMENSIONS b1, L1, L2 APPLY TO PLATED TERMINALS.
 7. THE LOCATION AND SIZE OF EJECTOR MARKS ARE OPTIONAL.
 8. THE LOCATION AND NUMBER OF FUSED LEADS ARE OPTIONAL.

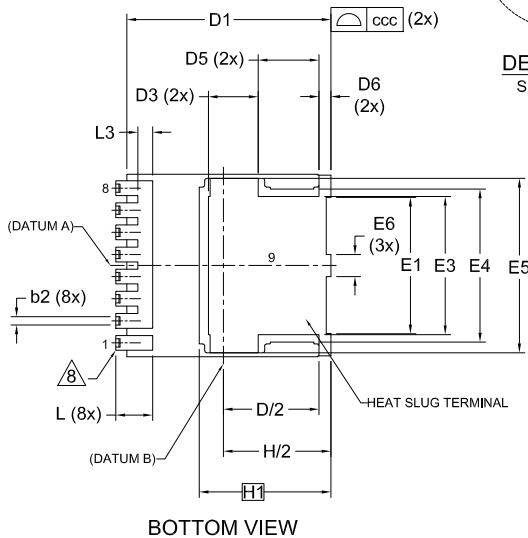

GENERIC MARKING DIAGRAM*

A = Assembly Location
Y = Year
WW = Work Week
ZZ = Assembly Lot Code
XXXX = Specific Device Code

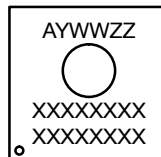

*This information is generic. Please refer to device data sheet for actual part marking. Pb-Free indicator, "G" or microdot "•", may or may not be present. Some products may not follow the Generic Marking.

DIM	MILLIMETERS		
	MIN.	NOM.	MAX.
A	2.20	2.30	2.40
A1	1.70	1.80	1.90
b	0.70	0.80	0.90
b1	9.70	9.80	9.90
b2	0.35	0.45	0.55
c	0.40	0.50	0.60
D	10.28	10.38	10.48
D/2	5.09	5.19	5.29
D1	10.98	11.08	11.18
D2	3.20	3.30	3.40
D3	2.60	2.70	2.80
D4	4.45	4.55	4.65
D5	3.20	3.30	3.40
D6	0.55	0.65	0.75
E	9.80	9.90	10.00
E1	7.30	7.40	7.50
E2	0.30	0.40	0.50
E3	7.40	7.50	7.60
E4	8.20	8.30	8.40

DIM	MILLIMETERS		
	MIN.	NOM.	MAX.
E5	9.36	9.46	9.47
E6	1.10	1.20	1.30
E7	0.15	0.18	0.21
e	1.20 BSC		
e/2	0.60 BSC		
H	11.58	11.68	11.78
H/2	5.74	5.84	5.94
H1	7.15 BSC		
L	1.90	2.00	2.10
L1	0.60	0.70	0.80
L2	0.50	0.60	0.70
L3	0.70	0.80	0.90
θ	10° REF		
θ1	10° REF		
aaa	0.20		
bbb	0.25		
ccc	0.20		
ddd	0.20		
eee	0.10		

DOCUMENT NUMBER:	98AON13813G	Electronic versions are uncontrolled except when accessed directly from the Document Repository. Printed versions are uncontrolled except when stamped "CONTROLLED COPY" in red.
DESCRIPTION:	H-PSOF8L 11.68x9.80x2.30, 1.20P	PAGE 1 OF 1

onsemi and ONSEMI are trademarks of Semiconductor Components Industries, LLC dba onsemi or its subsidiaries in the United States and/or other countries. onsemi reserves the right to make changes without further notice to any products herein. onsemi makes no warranty, representation or guarantee regarding the suitability of its products for any particular purpose, nor does onsemi assume any liability arising out of the application or use of any product or circuit, and specifically disclaims any and all liability, including without limitation special, consequential or incidental damages. onsemi does not convey any license under its patent rights nor the rights of others.

onsemi, **Onsemi**, and other names, marks, and brands are registered and/or common law trademarks of Semiconductor Components Industries, LLC dba "**onsemi**" or its affiliates and/or subsidiaries in the United States and/or other countries. **onsemi** owns the rights to a number of patents, trademarks, copyrights, trade secrets, and other intellectual property. A listing of **onsemi**'s product/patent coverage may be accessed at www.onsemi.com/site/pdf/Patent-Marking.pdf. **onsemi** reserves the right to make changes at any time to any products or information herein, without notice. The information herein is provided "as-is" and **onsemi** makes no warranty, representation or guarantee regarding the accuracy of the information, product features, availability, functionality, or suitability of its products for any particular purpose, nor does **onsemi** assume any liability arising out of the application or use of any product or circuit, and specifically disclaims any and all liability, including without limitation special, consequential or incidental damages. Buyer is responsible for its products and applications using **onsemi** products, including compliance with all laws, regulations and safety requirements or standards, regardless of any support or applications information provided by **onsemi**. "Typical" parameters which may be provided in **onsemi** data sheets and/or specifications can and do vary in different applications and actual performance may vary over time. All operating parameters, including "Typicals" must be validated for each customer application by customer's technical experts. **onsemi** does not convey any license under any of its intellectual property rights nor the rights of others. **onsemi** products are not designed, intended, or authorized for use as a critical component in life support systems or any FDA Class 3 medical devices or medical devices with a same or similar classification in a foreign jurisdiction or any devices intended for implantation in the human body. Should Buyer purchase or use **onsemi** products for any such unintended or unauthorized application, Buyer shall indemnify and hold **onsemi** and its officers, employees, subsidiaries, affiliates, and distributors harmless against all claims, costs, damages, and expenses, and reasonable attorney fees arising out of, directly or indirectly, any claim of personal injury or death associated with such unintended or unauthorized use, even if such claim alleges that **onsemi** was negligent regarding the design or manufacture of the part. **onsemi** is an Equal Opportunity/Affirmative Action Employer. This literature is subject to all applicable copyright laws and is not for resale in any manner.

ADDITIONAL INFORMATION

TECHNICAL PUBLICATIONS:

Technical Library: www.onsemi.com/design/resources/technical-documentation
onsemi Website: www.onsemi.com

ONLINE SUPPORT: www.onsemi.com/support

For additional information, please contact your local Sales Representative at www.onsemi.com/support/sales



Looking for pricing, stock, or lifecycle information?

Click below to explore more details on WIN SOURCE:

 [View NTBLS4D0N15MC on WIN SOURCE](#)

 [ON Semiconductor](#) Information

Optimize Your Supply Chain with WIN SOURCE Solutions

-  Global Sourcing Solution
-  Obsolete Management
-  Cost Control Management
-  Shortage Management
-  Alternative Solution
-  Excess Inventory Management