



**THE DATASHEET OF
LSIC1MO120E0080**



LSIC1MO120E0080

1200 V, 80 mOhm N-Channel SiC MOSFET

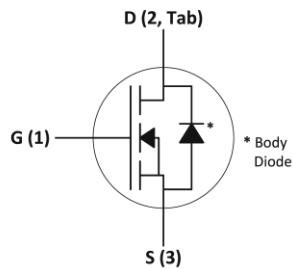
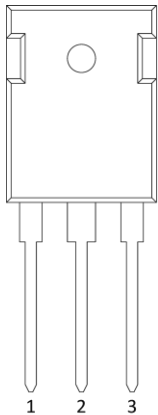


Agency Approvals and Environmental

Environmental Approvals



Circuit Diagram



Product Summary

Characteristic	Value	Unit
V_{DS}	1200	V
Typical $R_{DS(ON)}$	80	mOhm
I_D ($T_C \leq 100^\circ C$)	25	A

Features

- Optimized for high-frequency, high-efficiency applications
- Extremely low gate charge and output capacitance
- Low gate resistance for high-frequency switching
- Normally-off operations at all temperatures
- Ultra-low on-resistance

Applications

- High-frequency applications
- Solar Inverters
- Switch Mode Power Supplies
- UPS
- Motor Drives
- High Voltage DC/DC Converters
- Battery Chargers
- Induction Heating

1. Maximum Ratings.....	3
2. Thermal Characteristics	3
3. Electrical Characteristics.....	3
3.1. Static Characteristics ($T_J = 25\text{ }^\circ\text{C}$ unless otherwise specified).....	3
3.2. Dynamic Characteristics ($T_J = 25\text{ }^\circ\text{C}$ unless otherwise specified).....	3
4. Reverse Diode Characteristics	4
5. Performance Curves	5
6. Package Dimensions	9
7. Part Numbering and Marking.....	9
8. Packing Options.....	9
9. Packing Specifications	10

1. Maximum Ratings

Characteristic	Symbol	Conditions	Value	Unit
Drain-Source Voltage	V_{DS}	$V_{GS} = 0\text{ V}$	1200	V
Continuous Drain Current	I_D	$V_{GS} = 20\text{ V}, T_C = 25\text{ }^\circ\text{C}$	39	A
		$V_{GS} = 20\text{ V}, T_C = 100\text{ }^\circ\text{C}$	25	
Pulsed Drain Current ¹	$I_{D(pulse)}$	$T_C = 25\text{ }^\circ\text{C}$	80	A
Power Dissipation	P_D	$T_C = 25\text{ }^\circ\text{C}, T_J = 175\text{ }^\circ\text{C}$	214	W
Gate-Source Voltage	$V_{GS,MAX}$	Absolute maximum values – Steady state	-6 to +22	V
	$V_{GS,OP,TR}$ ²	Transient, $t_{transient} < 300\text{ nsec}$	-10 to +25	
	$V_{GS,OP}$ ³	Recommended DC operating values	-5 to +20	
Operating Junction Temperature	T_J	-	-55 to +175	$^\circ\text{C}$
Storage Temperature	T_{STG}	-	-55 to +150	$^\circ\text{C}$
Mounting Torque	M_D	M3 or 6-32 screw	0.6	Nm
			5.3	in-lb

Footnote 1: Pulse width limited by $T_{J,MAX}$

Footnote 2: See Figure 21 for further information

Footnote 3: MOSFET can operate with $V_{GS(OFF)} = 0\text{ V}$ – dependent upon PCB layout. $V_{GS(OFF)} = -5\text{ V}$ provides added noise margin and faster turn-off speed

2. Thermal Characteristics

Characteristic	Symbol	Value	Unit
Maximum Thermal Resistance, junction-to-case	$R_{th,JC,MAX}$	0.7	$^\circ\text{C/W}$
Maximum Thermal Resistance, junction-to-ambient	$R_{th,JA,MAX}$	40	$^\circ\text{C/W}$

3. Electrical Characteristics

3.1. Static Characteristics ($T_J = 25\text{ }^\circ\text{C}$ unless otherwise specified)

Characteristic	Symbol	Conditions	Value			Unit
			Min	Typ	Max	
Drain-Source Breakdown Voltage	$V_{(BR)DSS}$	$V_{GS} = 0\text{ V}, I_D = 100\text{ }\mu\text{A}$	1200	-	-	V
Zero Gate Voltage Drain Current	I_{DSS}	$V_{DS} = 1200\text{ V}, V_{GS} = 0\text{ V}$	-	1	100	μA
		$V_{DS} = 1200\text{ V}, V_{GS} = 0\text{ V}, T_J = 175\text{ }^\circ\text{C}$	-	2	-	
Gate Leakage Current	$I_{GSS,F}$	$V_{GS} = 22\text{ V}, V_{DS} = 0\text{ V}$	-	-	100	nA
	$I_{GSS,R}$	$V_{GS} = -6\text{ V}, V_{DS} = 0\text{ V}$	-	-	100	
Drain-Source On-State Resistance	$R_{DS(ON)}$	$I_D = 20\text{ A}, V_{GS} = 20\text{ V}$	-	80	100	m Ω
		$I_D = 20\text{ A}, V_{GS} = 20\text{ V}, T_J = 175\text{ }^\circ\text{C}$	-	120	-	
Gate Threshold Voltage	$V_{GS(TH)}$	$V_{DS} = V_{GS}, I_D = 10\text{ mA}$	1.8	2.8	4.0	V
		$V_{DS} = V_{GS}, I_D = 10\text{ mA}, T_J = 175\text{ }^\circ\text{C}$	-	1.8	-	
Internal Gate Resistance	$R_{G,int}$	Resonance method, Drain-Source shorted ¹	-	0.6	-	Ω

Footnote 1: For a description of the resonance method for measuring R_G , refer to the JEDEC Standard JESD24-11 test method

3.2. Dynamic Characteristics (T_J = 25 °C unless otherwise specified)

Characteristic	Symbol	Conditions	Value			Unit
			Min	Typ	Max	
Turn-On Switching Energy	E _{ON}	V _{DD} = 800 V, I _D = 20 A, V _{GS} = -5 / +20 V, R _{G,ext} = 2 Ω, L = 714 μH, FWD = LSIC2SD120A10	-	220	-	μJ
Turn-Off Switching Energy	E _{OFF}		-	32	-	
Total Per-Cycle Switching Energy	E _{TS}		-	252	-	
Input Capacitance	C _{ISS}	V _{DD} = 800 V, V _{GS} = 0 V, f = 1 MHz, V _{AC} = 25 mV	-	1700	-	pF
Output Capacitance	C _{OSS}		-	82	-	
Reverse Transfer Capacitance	C _{RSS}		-	9	-	
COSS Stored Energy	E _{OSS}		-	26	-	
Total Gate Charge	Q _g	V _{DD} = 800 V, I _D = 20 A, V _{GS} = -5 / +20 V	-	92	-	nC
Gate-Source Charge	Q _{gs}		-	28	-	
Gate-Drain Charge	Q _{gd}		-	35	-	
Turn-On Delay Time	t _{d(on)}	V _{DD} = 800 V, I _D = 20 A, V _{GS} = -5 / +20 V, R _{G,ext} = 2 Ω, R _L = 40 Ω, Timing relative to V _{DS}	-	10	-	ns
Rise Time	t _r		-	10	-	
Turn-Off Delay Time	t _{d(off)}		-	16	-	
Fall Time	t _f		-	8	-	

4. Reverse Diode Characteristics

Characteristic	Symbol	Conditions	Value			Unit
			Min	Typ	Max	
Diode Forward Voltage	V _{SD}	I _S = 10 A, V _{GS} = 0 V	-	3.6	-	V
		I _S = 10 A, V _{GS} = 0 V, T _J = 175 °C	-	3.2	-	
Continuous Diode Forward Current	I _S	V _{GS} = 0 V, T _C = 25 °C	-	-	35	A
Peak Diode Forward Current ¹	I _{SP}		-	-	85	
Reverse Recovery Time	t _{rr}	V _{GS} = -5 V, I _S = 20 A, V _R = 800 V, di/dt = 5.5 A/ns	-	21	-	ns
Reverse Recovery Charge	Q _{rr}		-	210	-	nC
Peak Reverse Recovery Current	I _{rrm}		-	19	-	A

Footnote 1: Pulse width limited by T_{J,MAX}

5. Performance Curves

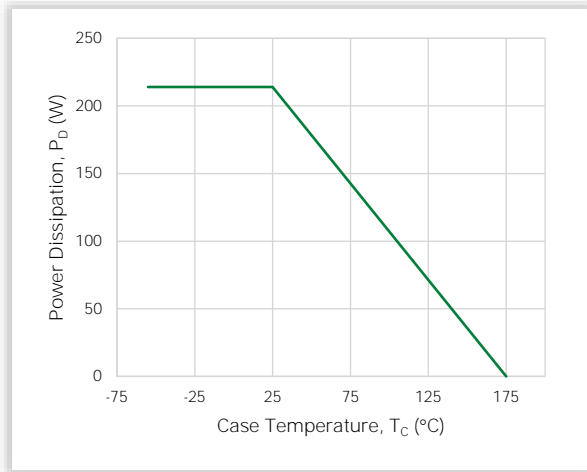
 Figure 1. Maximum Power Dissipation ($T_J = 175\text{ }^\circ\text{C}$)


Figure 2. Typical Transfer Characteristics

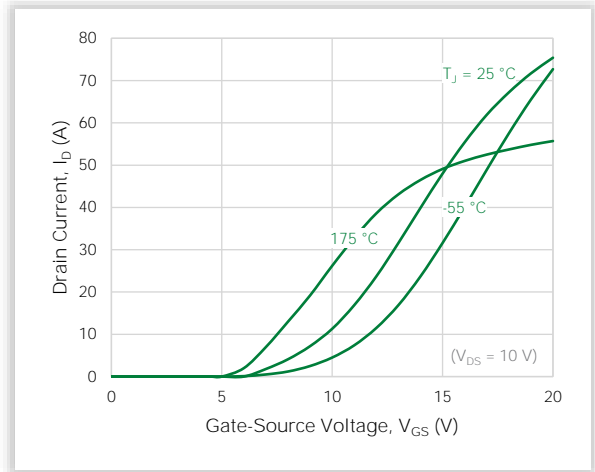
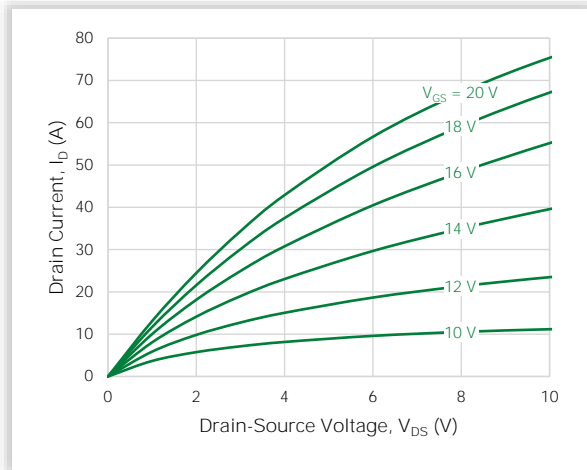
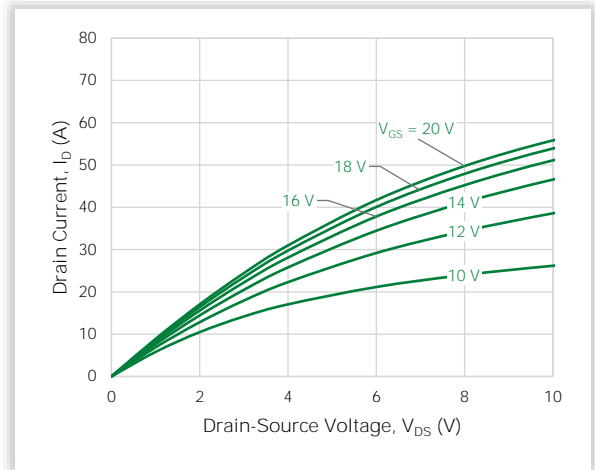
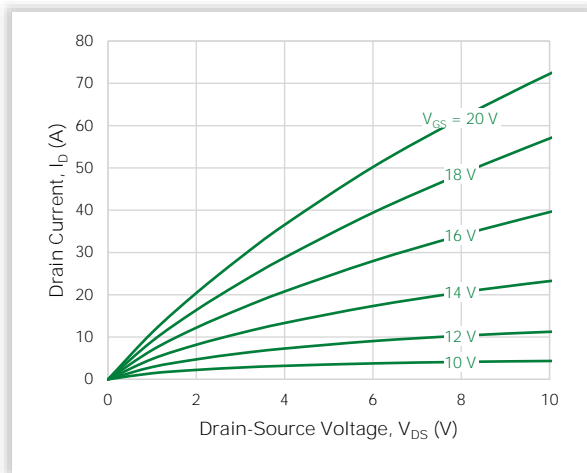
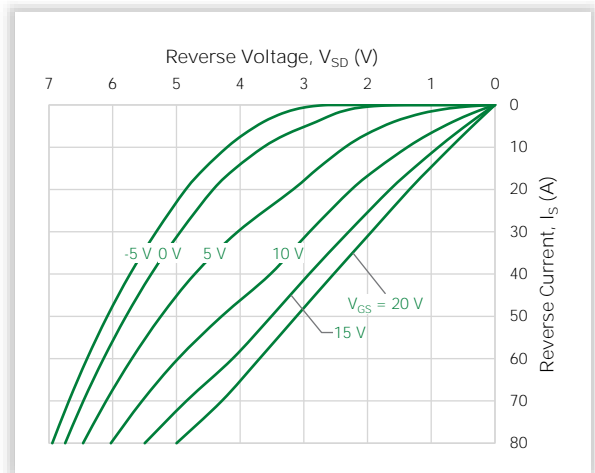

 Figure 3. Typical Output Characteristics ($T_J = 25\text{ }^\circ\text{C}$)

 Figure 4. Typical Output Characteristics ($T_J = 175\text{ }^\circ\text{C}$)

 Figure 5. Typical Output Characteristics ($T_J = -55\text{ }^\circ\text{C}$)

 Figure 6. Typical Reverse Conduction Characteristics ($T_J = 25\text{ }^\circ\text{C}$)


Figure 7. Typical Reverse Conduction Characteristics ($T_J = 175\text{ }^\circ\text{C}$)

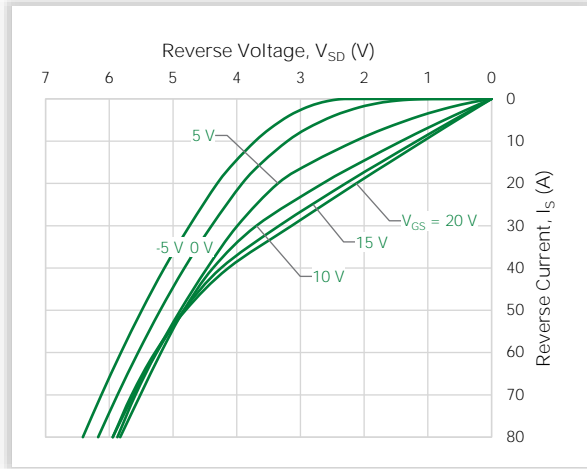


Figure 8. Typical Reverse Conduction Characteristics ($T_J = -55\text{ }^\circ\text{C}$)

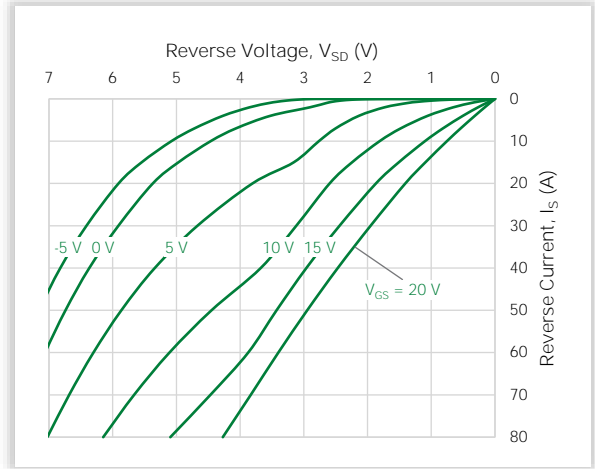


Figure 9. Normalized Transient Thermal Impedance

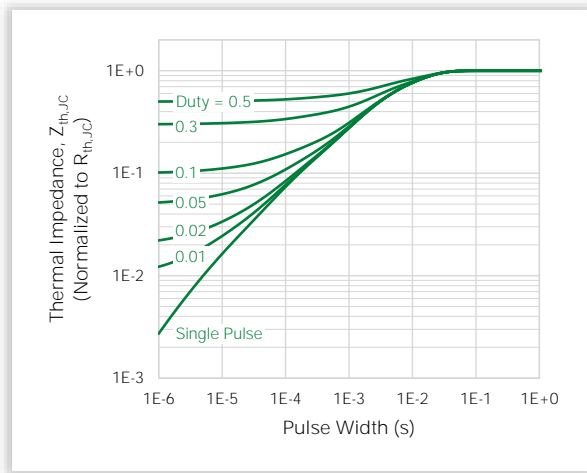


Figure 10. Maximum Safe Operating Area ($T_C = 25\text{ }^\circ\text{C}$)

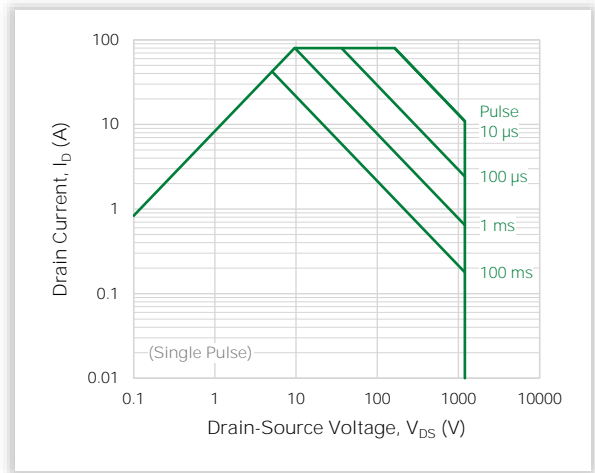


Figure 11. On-resistance vs. Drain Current

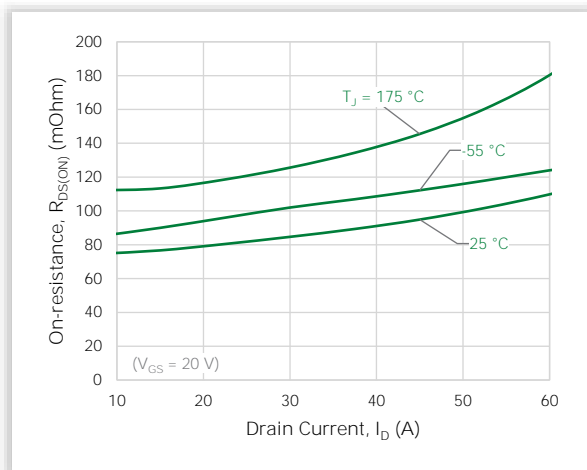


Figure 12. Normalized On-resistance vs. Junction Temperature

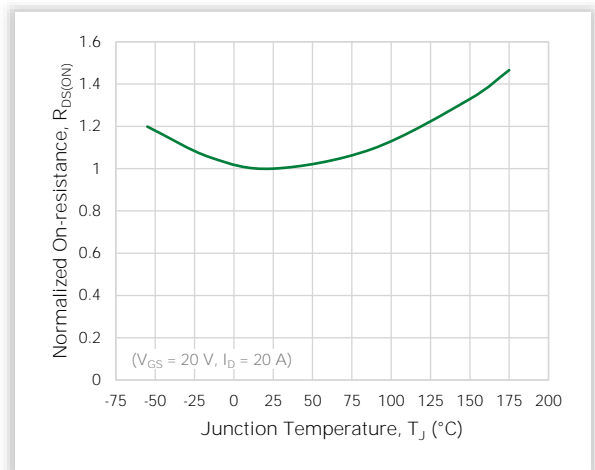


Figure 13. Typical On-resistance vs. Junction Temperature

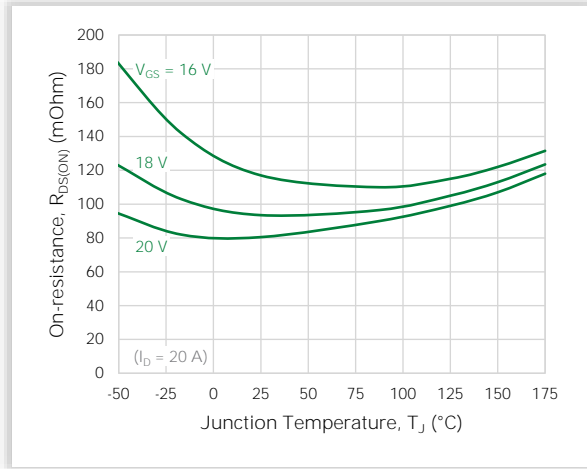


Figure 14. Typical Threshold Voltage

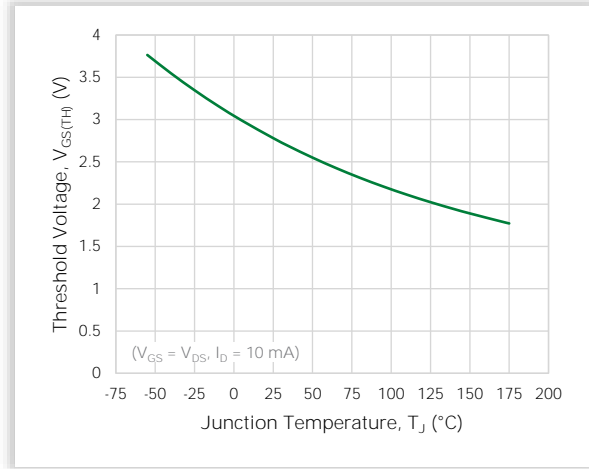


Figure 15. Typical Junction Capacitances up to 1000 V

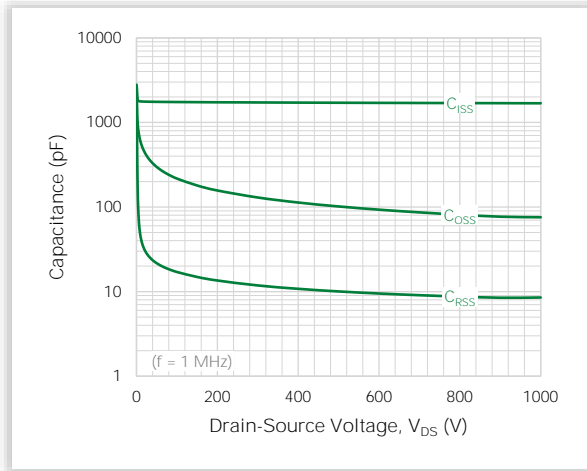


Figure 16. Typical Junction Capacitances up to 200 V

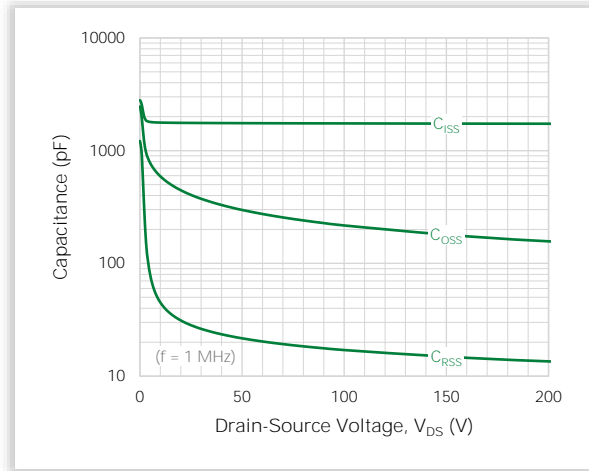


Figure 17. Typical C_{OSS} Stored Energy E_{OSS}

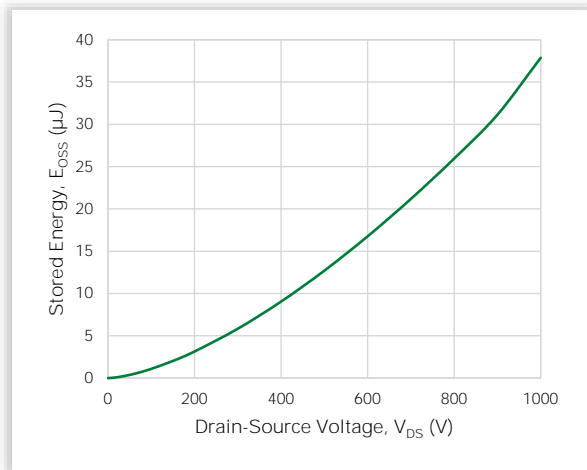


Figure 18. Typical Gate Charge

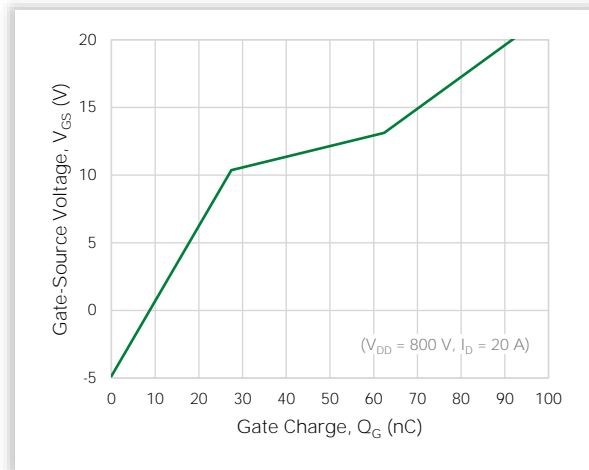


Figure 19. Typical Switching Energy vs. Drain Current

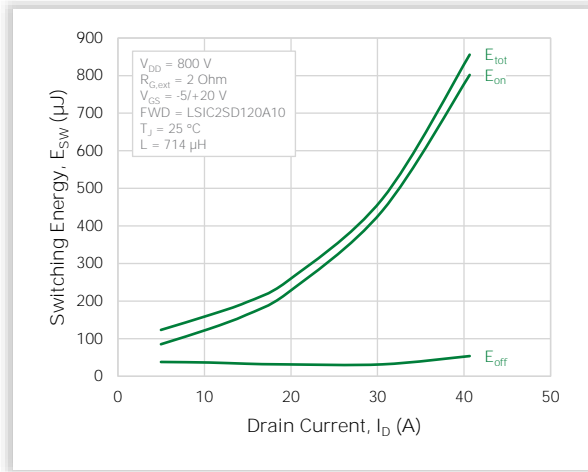
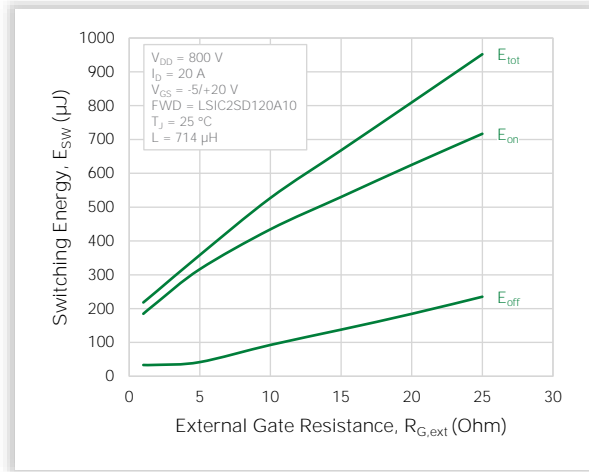
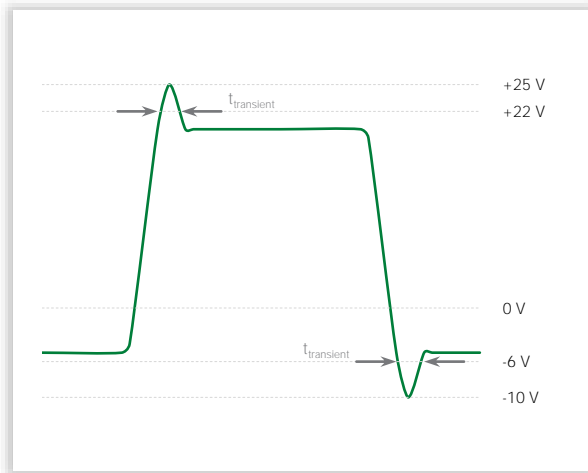
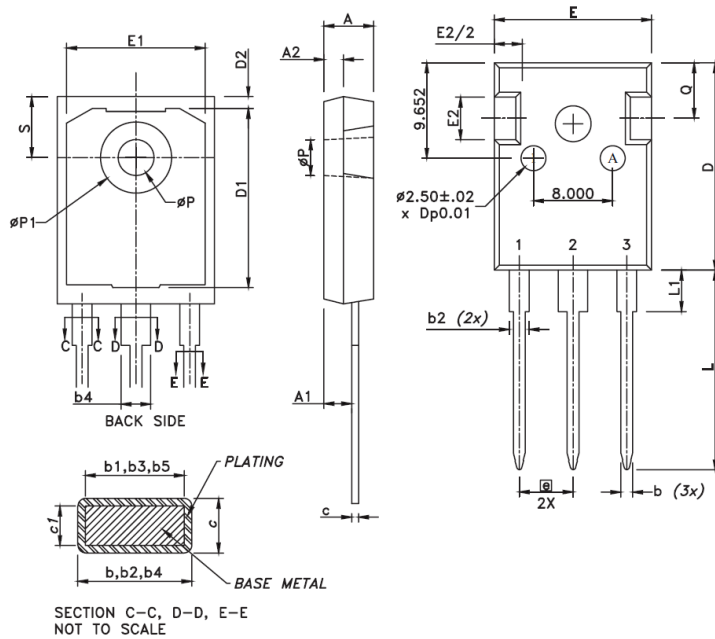


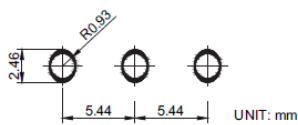
Figure 20. Typical Switching Energy vs. External Gate Resistance


 Figure 21. V_{GS} Waveform Definitions


6. Package Dimensions



Recommended Hole Pattern Layout:

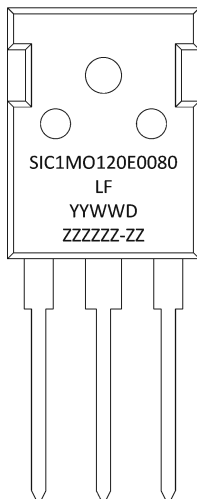


Notes:

1. Dimensions are in millimeters
2. Dimension D, E do not include mold flash. Mold flash shall not exceed 0.127 mm per side measured at outer most extreme of plastic body.
3. ϕP to have a maximum draft angle of 1.7° to the top of the part with a maximum hole diameter of 3.912 mm.

Symbol	Millimeters		
	Min	Nom	Max
A	4.699	-	5.309
A1	2.210	-	2.591
A2	1.499	-	2.489
b	0.990	-	1.400
b2	1.650	-	2.390
b4	2.590	-	3.430
c	0.380	-	0.890
D	20.800	-	21.463
D1	13.081	-	-
D2	0.508	-	1.350
e	5.440 BSC		
E	15.494	-	16.256
E1	13.060	-	14.150
E2	3.429	-	5.486
L	19.810	-	20.570
L1	3.810	-	4.496
ϕP	3.550	-	3.660
$\phi P1$	7.060	-	7.390
Q	5.385	-	6.200
S	6.050	-	6.300

7. Part Numbering and Marking

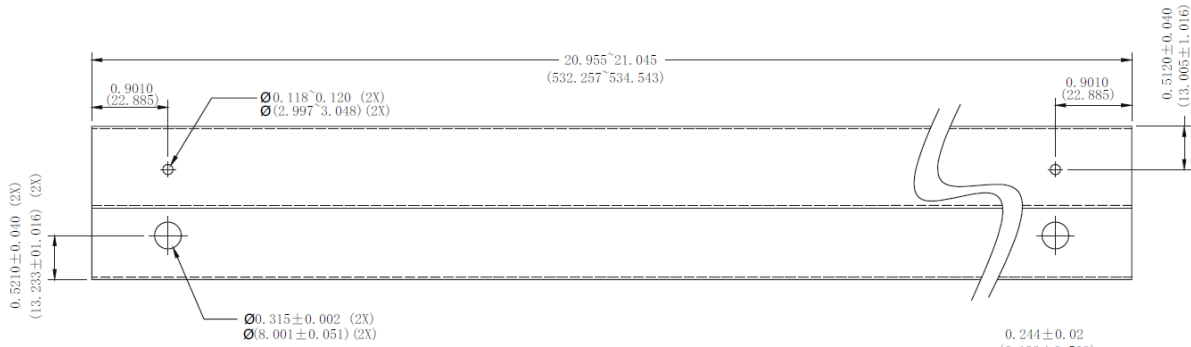


SiC	= SiC
1	= Gen 1
MO	= MOSFET
120	= Voltage Rating (1200 V)
E	= TO-247-3L
0080	= $R_{DS(ON)}$ (80 mOhm)
YY	= Year
WW	= Week
D	= Special Code
ZZZZZZ-ZZ	= Lot Number

8. Packing Options

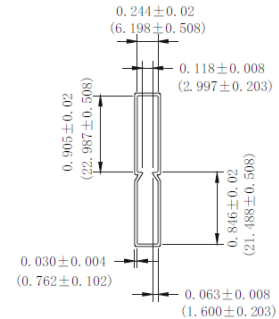
Part Number	Marking	Packing Mode	M.O.Q.
LSIC1MO120E0080	SIC1MO120E0080	Tube (30 pcs)	450

9. Packing Specifications



NOTE:

1. All pin plug holes are considered critical dimension
2. Tolerance is to be ± 0.010 unless otherwise specified
3. Dimension are in inch (and millimeters).



For additional information please visit www.Littelfuse.com/powersemi

Disclaimer Notice - Littelfuse products are not designed for, and shall not be used for, any purpose (including, without limitation, automotive, military, aerospace, medical, life-saving, life-sustaining or nuclear facility applications, devices intended for surgical implant into the body, or any other application in which the failure or lack of desired operation of the product may result in personal injury, death, or property damage) other than those expressly forth in applicable Littelfuse product documentation. Littelfuse shall not be liable for any claims or damages arising out of products used in applications not expressly intended by Littelfuse as set forth in applicable Littelfuse documentation.

Read complete Disclaimer Notice at www.littelfuse.com/disclaimer-electronics

Looking for pricing, stock, or lifecycle information?

Click below to explore more details on WIN SOURCE:

 [View LSIC1MO120E0080 on WIN SOURCE](#)

 [Littelfuse Inc. Information](#)

Optimize Your Supply Chain with WIN SOURCE Solutions

-  Global Sourcing Solution
-  Obsolete Management
-  Cost Control Management
-  Shortage Management
-  Alternative Solution
-  Excess Inventory Management