



# THE DATASHEET OF SMBJ5362B-TP



### Features

- Low Profile Package for Surface Mounting(Flat Handling Surface for Accurate Placement)
- Zener Voltage 5.1V to 200V
- Available on Tape and Reel(See E1A Std RS-481)
- Halogen Free. "Green" Device (Note 1)
- Moisture Sensitivity Level 1
- Epoxy Meets UL 94 V-0 Flammability Rating
- Lead Free Finish/RoHS Compliant (Note 2) ("P" Suffix Designates Compliant. See Ordering Information)

### Maximum Ratings

- Operating Junction Temperature Range: -55°C to +150°C
- Storage Temperature Range: -55°C to +150°C
- Thermal Resistance: 15°C/W Junction to Lead
- Thermal Resistance: 90°C/W Junction to Ambient(Note3)

Parameter	Symbol	Rating	Conditions
Steady State Power Dissipation	$P_{(AV)}$	5.0W	Note 4
Maximum Forward Voltage	$V_F$	1.2V	$I_F=1.0mA$

**Note:**

- 1.Halogen free "Green"products are defined as those which contain <900ppm bromine, <900ppm chlorine (<1500ppm total Br + Cl) and <1000ppm antimony compounds.
- 2.High Temperature Solder Exemption Applied, See EU Directive Annex 7a.
- 3.Ambient Temperature at 15°C =  $T_A$  at Mounting Plane. Derate Linearly Above 15°C to Zero Power at 150°C
- 4.Lead Temperature at 75°C =  $T_L$  at Mounting Plane. Derate Linearly Above 75°C to Zero Power at 150°C

### Device Marking:

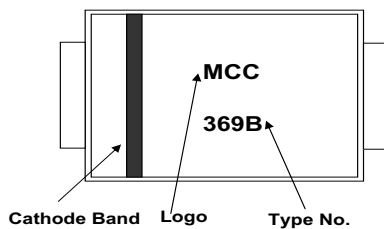

For Example: 339B for SMBJ5339B  
369B for SMBJ5369B

## 5.0 Watt Surface Mount Silicon Zener Diodes 5.1V to 200V

### SMB (DO-214AA) (LEAD FRAME)

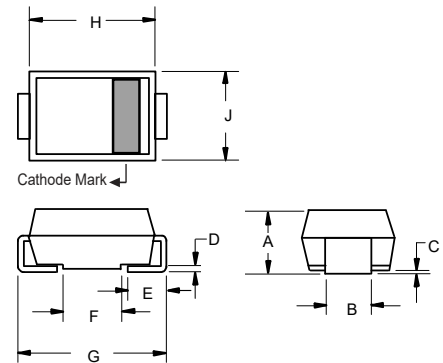

DIM	INCHES		MM		NOTE
	MIN	MAX	MIN	MAX	
A	0.079	0.103	2.00	2.62	
B	0.075	0.087	1.91	2.21	
C	0.002	0.008	0.05	0.20	
D	0.006	0.012	0.15	0.31	
E	0.030	0.060	0.76	1.52	
F	0.065	0.091	1.65	2.32	
G	0.200	0.220	5.08	5.59	
H	0.160	0.191	4.06	4.85	
J	0.130	0.155	3.30	3.94	

### SUGGESTED SOLDER PAD LAYOUT

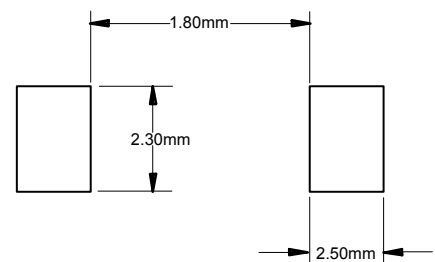

Electrical Characteristics @ 25°C Unless Otherwise Specified

MCC Part Number	Regulator Voltage	Test Current	Maximum Dynamic Impedance	Maximum Reverse Current	Test Voltage	Maximum Regulator Current	Maximum Dynamic Knee Impedance	Maximum Surge Current	Maximum Voltage Regulation
	$V_Z$	$I_Z$	$Z_{ZT}$	$I_R$	$V_R$	$I_{ZM}$	$Z_{Zk} @ 1.0mA$	$I_{ZSM}$	
	V	mA	$\Omega$	$\mu A$	V	mA	$\Omega$	A	V
SMBJ5338B	5.1	240	1.5	1	1	930	400	14.4	0.39
SMBJ5339B	5.6	220	1	1	2	865	400	13.4	0.25
SMBJ5340B	6	200	1	1	3	790	300	12.7	0.19
SMBJ5341B	6.2	200	1	1	3	765	200	12.4	0.1
SMBJ5342B	6.8	175	1	10	5.2	700	200	11.5	0.15
SMBJ5343B	7.5	175	1.5	10	5.7	630	200	10.7	0.15
SMBJ5344B	8.2	150	1.5	10	6.2	580	200	10	0.2
SMBJ5345B	8.7	150	2	10	6.6	545	200	9.5	0.2
SMBJ5346B	9.1	150	2	7.5	6.9	520	150	9.2	0.22
SMBJ5347B	10	125	2	5	7.6	475	125	8.6	0.22
SMBJ5348B	11	125	2.5	5	8.4	430	125	8	0.25
SMBJ5349B	12	100	2.5	2	9.1	395	125	7.5	0.25
SMBJ5350B	13	100	2.5	1	9.9	365	100	7	0.25
SMBJ5351B	14	100	2.5	1	10.6	340	75	6.7	0.25
SMBJ5352B	15	75	2.5	1	11.5	315	75	6.3	0.25
SMBJ5353B	16	75	2.5	1	12.2	295	75	6	0.3
SMBJ5354B	17	70	2.5	0.5	12.9	280	75	5.8	0.35
SMBJ5355B	18	65	2.5	0.5	13.7	264	75	5.5	0.4
SMBJ5356B	19	65	3	0.5	14.4	250	75	5.3	0.4
SMBJ5357B	20	65	3	0.5	15.2	237	75	5.1	0.4
SMBJ5358B	22	50	3.5	0.5	16.7	216	75	4.7	0.45
SMBJ5359B	24	50	3.5	0.5	18.2	198	100	4.4	0.55
SMBJ5360B	25	50	4	0.5	19	190	110	4.3	0.55
SMBJ5361B	27	50	5	0.5	20.6	176	120	4.1	0.6
SMBJ5362B	28	50	6	0.5	21.2	170	130	3.9	0.6
SMBJ5363B	30	40	8	0.5	22.8	158	140	3.7	0.6
SMBJ5364B	33	40	10	0.5	25.1	144	150	3.5	0.6
SMBJ5365B	36	30	11	0.5	27.4	132	160	3.3	0.65
SMBJ5366B	39	30	14	0.5	29.7	122	170	3.1	0.65
SMBJ5367B	43	30	20	0.5	32.7	110	190	2.8	0.7
SMBJ5368B	47	25	25	0.5	35.8	100	210	2.7	0.8
SMBJ5369B	51	25	27	0.5	38.8	93	230	2.5	0.9
SMBJ5370B	56	20	35	0.5	42.6	86	280	2.3	1
SMBJ5371B	60	20	40	0.5	45.5	79	350	2.2	1.2
SMBJ5372B	62	20	42	0.5	47.1	76	400	2.1	1.35
SMBJ5373B	68	20	44	0.5	51.7	70	500	2	1.5
SMBJ5374B	75	20	45	0.5	56	63	620	1.9	1.6
SMBJ5375B	82	15	65	0.5	62.2	58	720	1.8	1.8
SMBJ5376B	87	15	75	0.5	66	54.5	760	1.7	2
SMBJ5377B	91	15	75	0.5	69.2	52.5	760	1.6	2.2
SMBJ5378B	100	12	90	0.5	76	47.5	800	1.5	2.3
SMBJ5379B	110	12	125	0.5	83.6	43	1000	1.4	2.5
SMBJ5380B	120	10	170	0.5	91.2	39.5	1150	1.3	2.5
SMBJ5381B	130	10	190	0.5	98.8	36.6	1250	1.2	2.5
SMBJ5382B	140	8.0	230	0.5	106	34	1500	1.2	2.5
SMBJ5383B	150	8.0	330	0.5	114	31.6	1500	1.1	3
SMBJ5384B	160	8.0	350	0.5	122	29.4	1650	1.1	3
SMBJ5385B	170	8.0	380	0.5	129	28	1750	1.0	3
SMBJ5386B	180	5.0	430	0.5	137	26.4	1750	1.0	4
SMBJ5387B	190	5.0	450	0.5	144	25	1850	0.9	5
SMBJ5388B	200	5.0	480	0.5	152	23.6	1850	0.9	5

**Remarks:**

1. Devices Listed Have a  $\pm 5\%$  Tolerance on Nominal  $V_Z$ . Suffix C Denotes a +2%
2. Nominal Zener Voltage ( $V_Z$ ) is Tested With a 40 +/-10 Milliseconds Pulse Current at 25°C to Avoid Self-heat Affection.
3. The Zener Impedance ( $Z_{ZT}$  or  $Z_{ZK}$ ) is Derived from The 60Hz AC Voltage, Which Results When an AC Current Having a rms value Equal to 10% of the DC Zener Current ( $I_{ZT}$  or  $I_{ZK}$ ) Respectively.
4. The Maximum Reverse(Leakage) Current is Specified for Devices With  $\pm 20\%$  and  $\pm 10\%$  Voltage Tolerances on Nominal  $V_Z$  in Another Column.
5. The Maximum Zener Current( $I_{ZM}$ ) Shown is for  $\pm 5\%$  Tolerance Devices.  $I_{ZM}$  for  $\pm 10\%$  and  $\pm 20\%$  Devices Can be Calculated Using the Formula:

$$I_{ZM} = \frac{P}{V_{ZM}}$$

Where " $V_{ZM}$ " is  $V_Z$  at The High End of The Voltage Tolerance Specified and "P" is The Rated Power of The Device.

6. The Surge Current ( $I_{ZM}$ ) is Specified As The Maximum Peak of a Nonrecurring Sine Wave of 8.3 Milliseconds Duration.
7. Voltage Regulation ( $\Delta V_Z$ ) is The Difference Between The Voltage Measured at 10% and 50% ( $I_{ZM}$ ).

**Curve Characteristics**

Fig. 1 - Power Derating Curve

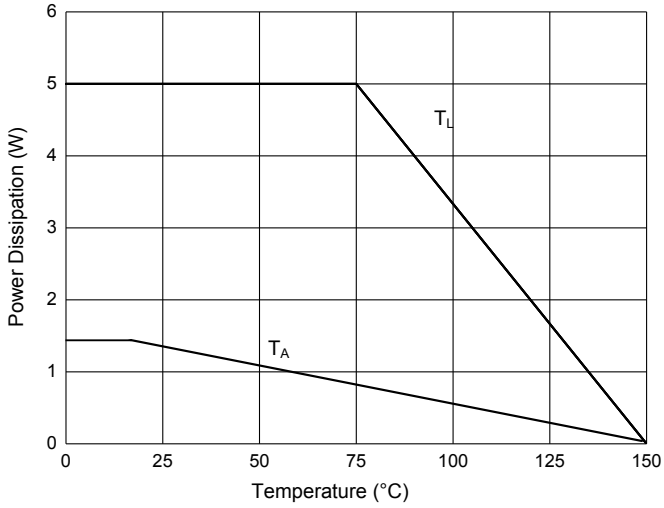

Fig. 2 - Typical Zener Breakdown Characteristics

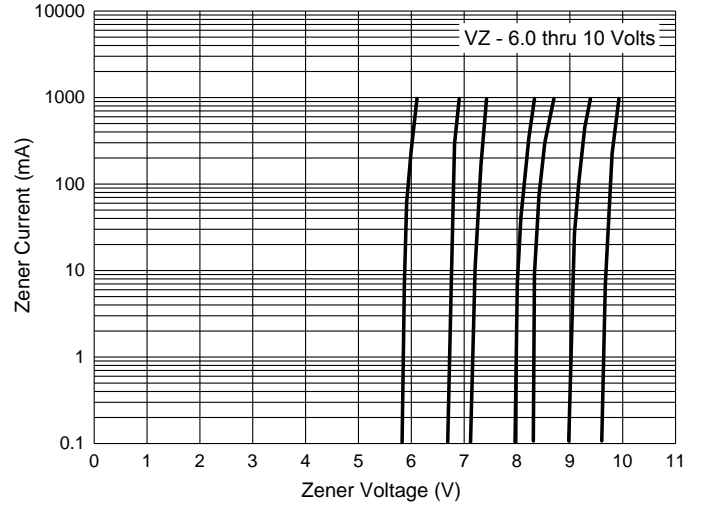

Fig. H - Typical Zener Breakdown Characteristics

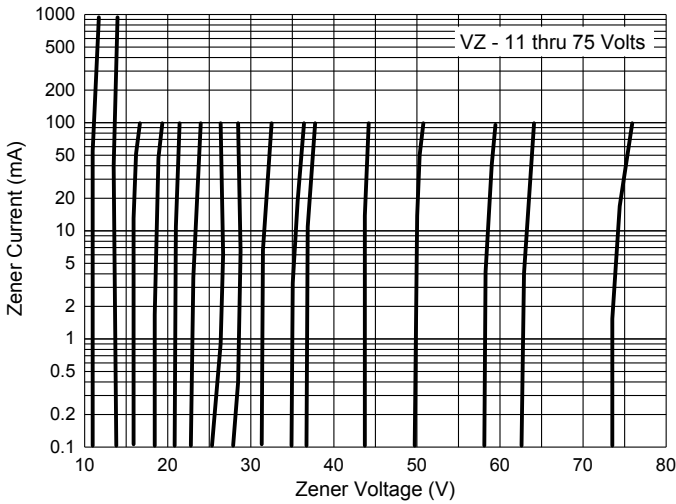

Fig. 4 - Typical Zener Breakdown Characteristics

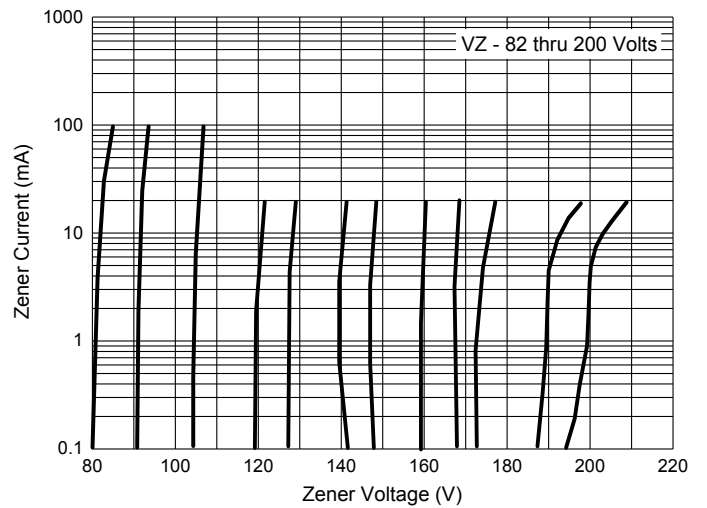

Fig. 5 - Maximum Surge Current VS Nominal Vz

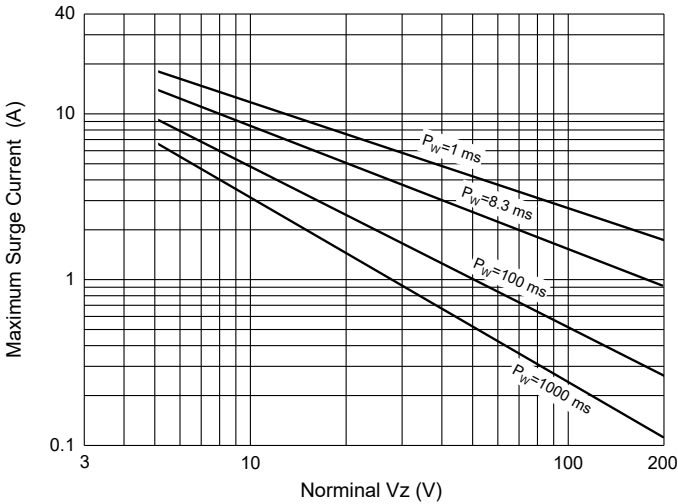
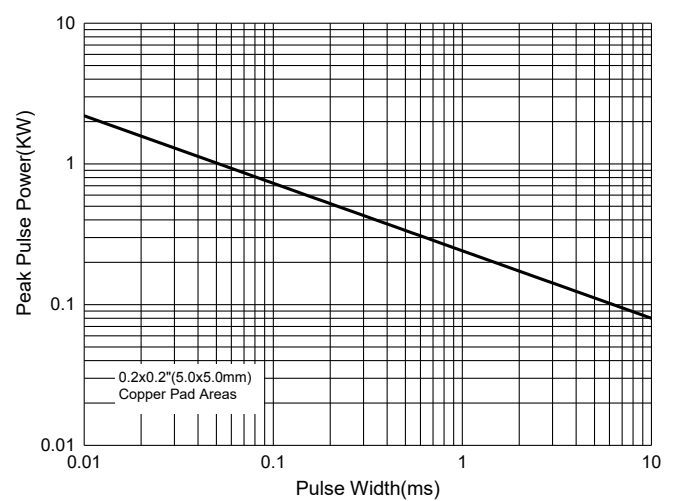

Fig. 6 - Non-Repetitive Peak Pulse Power



## Ordering Information

Device	Packing
Part Number-TP	Tape&Reel:3Kpcs/Reel

### \*\*\*IMPORTANT NOTICE\*\*\*

**Micro Commercial Components Corp.** reserves the right to make changes without further notice to any product herein to make corrections, modifications, enhancements, improvements, or other changes. **Micro Commercial Components Corp.** does not assume any liability arising out of the application or use of any product described herein; neither does it convey any license under its patent rights, nor the rights of others. The user of products in such applications shall assume all risks of such use and will agree to hold **Micro Commercial Components Corp.** and all the companies whose products are represented on our website, harmless against all damages. **Micro Commercial Components Corp.** products are sold subject to the general terms and conditions of commercial sale, as published at <https://www.mccsemi.com/Home/TermsAndConditions>.

### \*\*\*LIFE SUPPORT\*\*\*

MCC's products are not authorized for use as critical components in life support devices or systems without the express written approval of Micro Commercial Components Corporation.

### \*\*\*CUSTOMER AWARENESS\*\*\*



Counterfeiting of semiconductor parts is a growing problem in the industry. Micro Commercial Components (MCC) is taking strong measures to protect ourselves and our customers from the proliferation of counterfeit parts. MCC strongly encourages customers to purchase MCC parts either directly from MCC or from Authorized MCC Distributors who are listed by country on our web page cited below. Products customers buy either from MCC directly or from Authorized MCC Distributors are genuine parts, have full traceability, meet MCC's quality standards for handling and storage. **MCC will not provide any warranty coverage or other assistance for parts bought from Unauthorized Sources.** MCC is committed to combat this global problem and encourage our customers to do their part in stopping this practice by buying direct or from authorized distributors.

## Looking for pricing, stock, or lifecycle information?

Click below to explore more details on WIN SOURCE:

-  [View SMBJ5362B-TP](#) on WIN SOURCE
-  [Micro Commercial Co](#) Information

## Optimize Your Supply Chain with WIN SOURCE Solutions

-  Global Sourcing Solution
-  Obsolete Management
-  Cost Control Management
-  Shortage Management
-  Alternative Solution
-  Excess Inventory Management