



**THE DATASHEET OF
SET010103**



HIGH CURRENT HALF WAVE ASSEMBLIES

T-03-15

ABSOLUTE MAXIMUM RATINGS (@25°C UNLESS OTHERWISE SPECIFIED)

Device Type	Reverse Voltage		Average Forward Current		Repetitive Surge Current	1 Cycle Surge Current I _p =8.3ms	Reverse Recovery (4)	Forward Voltage		Reverse Current		Thermal Impedance	Operating & Storage Temp Range		Case Outline
	V _{RRM}	V _{RRM}	I _F (AV) @ T _c					I _{FRM}	I _{FSM}	T _{rr}	V _F		@I _F	I _R	
			55°C	100°C					@25°C		@25°C	@100°C			
	Volts	Volts	Amps	Amps	Amps	Amps	nS	Volts	Amps	μA	μA	°C/W	°C	°C	

ISOPAC RANGE

ISOPAC0103	1000	1000	15	11	25	150	2000	1.2	9	1	20	3.0	-55	175	G45
ISOPAC0104	400	400	15	11	25	150	150	1.5		1	20			175	
ISOPAC0111	150	150	15	10	24	175	30	1.1		10	500			150	
ISOPAC0112	600	600	15	11	25	150	2000	1.2		1	20			175	
ISOPAC0119	1000	1000	10	8	15	150	150	2.2		1	25			175	↓
ISOPAC0123	500	500	10	8	15	150	50	1.6		10	500			150	G45
ISOPAC0203	1000	1000	15	11	25	150	2000	1.2		1	20			175	G46
ISOPAC0204	400	400	15	11	25	150	150	1.5		1	20			175	
ISOPAC0211	150	150	15	10	24	175	30	1.1		10	500			150	
ISOPAC0212	600	600	15	11	25	150	2000	1.2		1	20			175	
ISOPAC0219	1000	1000	10	8	15	150	150	2.2		1	25			175	↓
ISOPAC0223	500	500	10	8	15	150	50	1.6		10	500			150	G46
ISOPAC0403	1000	1000	15	11	25	150	2000	1.2		1	20			175	G47
ISOPAC0404	400	400	15	11	25	150	150	1.5		1	20			175	
ISOPAC0411	150	150	15	10	24	175	30	1.1		10	500			150	
ISOPAC0412	600	600	15	11	25	150	2000	1.2		1	20			175	
ISOPAC0419	1000	1000	10	8	15	150	150	2.2		1	25			175	↓
ISOPAC0423	500	500	10	8	15	150	50	1.6		10	500			150	G47
ISOPAC0603	1000	1000	15	11	25	150	2000	1.2		1	20			175	G49
ISOPAC0604	400	400	15	11	25	150	150	1.5		1	20			175	
ISOPAC0611	150	150	15	10	24	175	30	1.1		10	500			150	
ISOPAC0612	600	600	15	11	25	150	2000	1.2		1	20			175	
ISOPAC0619	1000	1000	10	8	15	150	150	2.2		1	25			175	↓
ISOPAC0623	500	500	10	8	15	150	50	1.6		10	500			150	G49
ISOPAC1203	1000	1000	15	11	25	150	2000	1.2		1	20			175	G50
ISOPAC1204	400	400	15	11	25	150	150	1.5		1	20			175	
ISOPAC1211	150	150	15	10	24	175	30	1.1		10	500			150	
ISOPAC1212	600	600	15	11	25	150	2000	1.2		1	20			175	
ISOPAC1219	1000	1000	10	8	15	150	150	2.2		1	25			175	↓
ISOPAC1223	500	500	10	8	15	150	50	1.6		10	500			150	G50
SET01##03	1000	1000	15	11	25	150	2000	1.2		1	20			175	G57
SET01##04	400	400	15	11	25	150	150	1.5		1	20			175	
SET01##11	150	150	15	10	24	175	30	1.1		10	500			150	
SET01##12	600	600	15	11	25	150	2000	1.2		1	20			175	
SET01##19	1000	1000	10	8	15	150	150	2.2		1	25			175	↓
SET01##23	500	500	10	8	15	150	50	1.6		10	500	3.0		150	G57
SET04##03	1000	1000	30	22	50	250	2000	1.2	18	2	40			175	G58
SET04##04	400	400	30	22	50	250	150	1.5		2	40			175	
SET04##11	150	150	30	20	48	290	30	1.1		20	1000			150	
SET04##12	600	600	30	22	50	250	2000	1.2		2	40			175	
SET04##19	1000	1000	20	16	30	250	150	2.2		2	50			175	↓
SET04##23	500	500	20	16	30	250	50	1.6		20	1000	1.5	-55	150	G58

NOTES

- (1) Rating at Case Temperature T_c
Rating for each leg in multiple diode assemblies
- (4) Measured on discrete devices prior to assembly

Add code for configuration # #:
 01 = Non-isolated cathode to stud
 02 = Isolated cathode to stud
 03 = Non-isolated anode to stud
 04 = Isolated anode to stud

G45

DIM#	MM		INCHES		NOTE
	MIN	MAX	MIN	MAX	
A	14.2	15.0	.55	.59	--
B	6.8	7.4	.28	.29	--
C	9.6	11.2	.38	.44	--
D	4.5	6.1	.18	.24	--
E	3.0	3.3	.12	.13	--
F	4.8	5.3	.19	.21	--
G	7.9	10.2	.31	.40	--
H	2.2	3.0	.09	.12	--
J	1.78	1.3	.07	.05	--
K	2.8	3.1	.11	.12	DIA

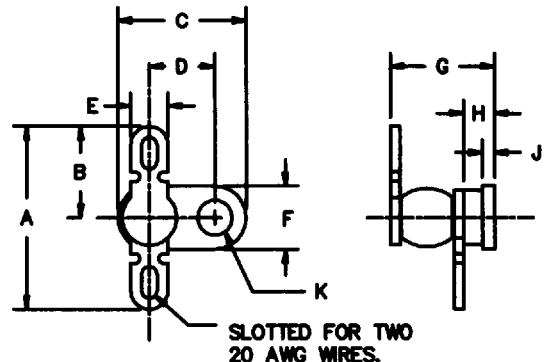

G46

DIM*	MM		INCHES		NOTE
	MIN	MAX	MIN	MAX	
A	-	17.3	-	.68	-
B	2.9	3.4	.115	.135	-
C	3.0	3.3	.12	.13	-
D	10.0	10.4	.39	.41	-
E	2.8	3.0	.11	.12	-
F	-	10.7	-	.42	-
G	2.3	3.0	.09	.12	-
H	1.0	1.3	.04	.05	-
J	11.2	11.9	.44	.47	-
X	3.5	3.8	.139	.149	DIA

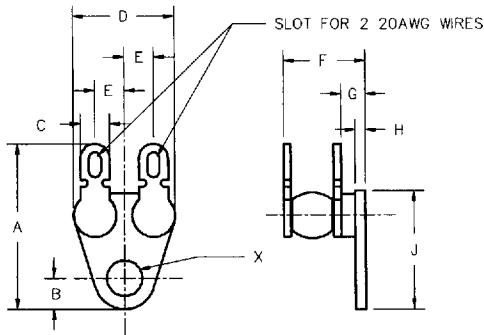

G47

DIM*	MM		INCHES		NOTE
	MIN	MAX	MIN	MAX	
A	29.7	30.5	1.17	1.20	-
B	8.6	10.2	.34	.40	-
C	3.3	4.1	.13	.16	-
D	1.7	2.3	.07	.09	-
E	19.5	20.1	.77	.79	-
F	4.2	4.4	.167	.171	DIA



G49

DIM*	MM		INCHES		NOTE
	MIN	MAX	MIN	MAX	
A	29.7	30.5	1.17	1.20	-
B	8.6	10.2	.34	.40	-
C	3.3	4.1	.13	.16	-
D	1.7	2.3	.07	.09	-
E	19.5	20.1	.77	.79	-
F	4.2	4.4	.167	.171	DIA

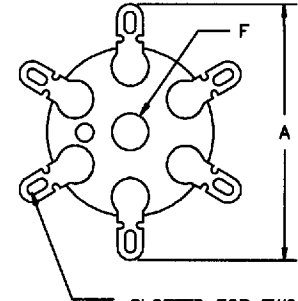

T-03-15

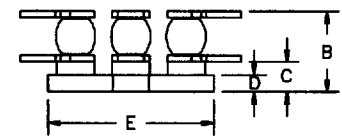
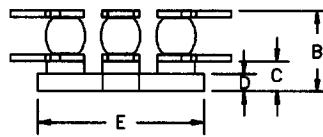

G50

DIM*	MM		INCHES		NOTE
	MIN	MAX	MIN	MAX	
A	38.3	39.2	1.51	1.54	-
B	10.1	10.9	.39	.43	-
C	4.3	5.1	.17	.20	-
D	3.0	3.3	.12	.13	-
E	27.6	28.4	1.09	1.12	-
F	6.7	6.8	.264	.268	DIA

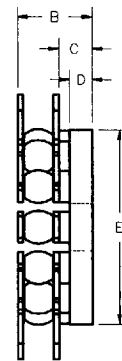
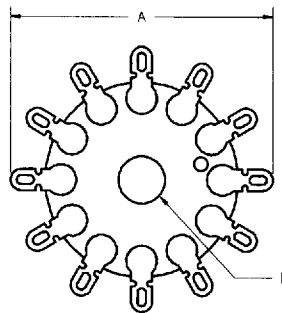

G57

DIM*	MM		INCHES		NOTE
	MIN	MAX	MIN	MAX	
A	5.8	7.4	.23	.29	-
B	4.5	4.8	.18	.19	-
C	3.0	3.3	.12	.13	-
D	14.2	16.5	.56	.65	-
E	2.7	3.3	.11	.13	-
F	6.0	6.6	.24	.26	-
G	1.2	1.5	.05	.06	-

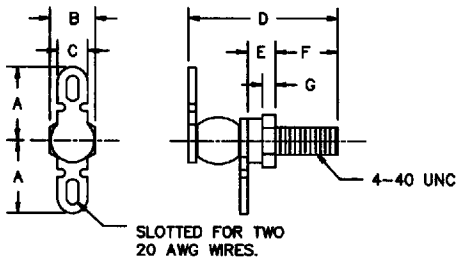

G56

DIM*	MM		INCHES		NOTE
	MIN	MAX	MIN	MAX	
A	12.3	15.2	.49	.60	-
B	10.8	12.4	.43	.49	-
C	11.4	12.4	.45	.49	-
D	5.5	6.1	.22	.24	-
E	9.3	9.4	.37	.37	-
F	13.7	14.8	.54	.59	-
G	10.8	11.4	.43	.45	-
H	8.1	9.3	.32	.37	-
J	4.0	4.6	.16	.18	-
X	1.6	1.9	.063	.075	DIA

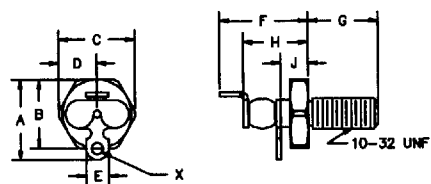

HIGH CURRENT HALF WAVE ASSEMBLIES (cont.)

ABSOLUTE MAXIMUM RATINGS (@25°C UNLESS OTHERWISE SPECIFIED)

T-03-15

Device Type	Reverse Voltage		Average Forward Current (1)		Repetitive Surge Current	1 Cycle Surge Current tp=8.3ms	Reverse Recovery (4)	Forward Voltage		Reverse Current		Thermal Impedance	Operating & Storage Temp Range		Case Outline
	V _{RM}	V _{RRM}	I _F (AV) @ T _c		I _{FRM}	I _{FSM}	T _{rr}	V _F	@I _F	I _r	I _r	θ _{JC}	Top & T _{stc}		
			55°C	100°C				@25°C		@25°C	@100°C		Min	Max	
	Volts	Volts	Amps	Amps	Amps	Amps	nS	Volts	Amps	µA	µA	°C/W	°C	°C	

UOPAC™ RANGE (cont.)

SET05##03	1000	1000	60	44	100	500	2000	1.2	36	4	80	0.75	65	175	G79
SET05##04	400	400	60	44	100	500	150	1.5		4	80			175	
SET05##11	150	150	60	40	96	580	30	1.1		40	2000			150	
SET05##12	600	600	60	44	100	500	2000	1.2		4	80			175	
SET05##19	1000	1000	40	32	60	500	150	2.2		4	320			175	
SET05##23	500	500	40	32	60	500	50	1.6	▼	40	2000	0.75		150	G79
SET10##03	1000	1000	90	66	150	750	2000	1.2	54	6	120	0.5		175	G74
SET10##04	400	400	90	66	150	750	150	1.5		6	120			175	
SET10##11	150	150	90	60	144	570	30	1.1		60	3000			150	
SET10##12	600	600	90	66	150	750	2000	1.2		6	120			175	
SET10##19	1000	1000	60	48	90	750	150	2.2		6	480	▼		175	▼
SET10##23	500	500	60	48	90	750	50	1.6	▼	60	3000	0.5		150	G74
SET13##03	1000	1000	15	11	25	150	2000	1.2	9	1	20	3.0		175	G76
SET13##04	400	400	15	11	25	150	150	1.5		1	20			175	
SET13##11	150	150	15	10	24	175	30	1.1		10	500			150	
SET13##12	600	600	15	11	25	150	2000	1.2		1	20			175	
SET13##19	1000	1000	10	8	15	150	150	2.2		1	80	▼	▼	175	▼
SET13##23	500	500	10	8	15	150	50	1.6	▼	10	500	3.0	-55	150	G76

NOTES:

- (1) Rating at Case Temperature T_c
- (4) Measured on discrete devices prior to assembly

Add code for configuration # #:

- 01 = Non-isolated cathode to stud
- 02 = Isolated cathode to stud
- 03 = Non-isolated anode to stud
- 04 = Isolated anode to stud

G79

DIM [#]	MM		INCHES		NOTE
	MIN	MAX	MIN	MAX	
A	14.0	14.3	.55	.56	—
B	6.6	7.4	.26	.29	—
C	14.2	15.3	.56	.60	—
D	10.4	11.5	.41	.45	—
E	6.0	6.6	.24	.26	—
F	8.8	9.7	.35	.38	—
G	10.9	11.5	.43	.45	—
H	3.5	4.1	.14	.16	—
J	2.0	2.6	.08	.10	—
X	3.8	4.1	.15	.16	DIA

NOTES:

- 1 POSITIVE TERMINAL DENOTED BY RED DOT

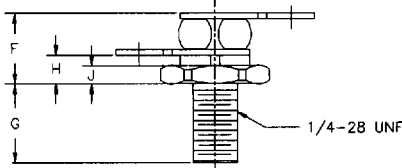
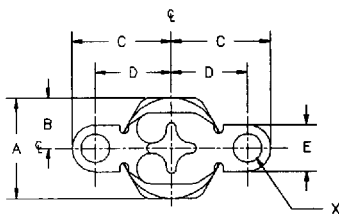

G74

DIM [#]	MM		INCHES		NOTE
	MIN	MAX	MIN	MAX	
A	17.0	17.6	.67	.69	—
B	18.7	19.3	.74	.76	—
C	19.5	20.6	.77	.81	—
D	10.6	11.7	.42	.46	—
E	13.9	15.0	.55	.59	—
F	—	11.0	—	.43	—
G	4.3	—	.17	—	—
H	2.5	3.1	.10	.12	—
J	7.3	7.9	.29	.31	—
K	—	25.4	—	1.0	—
L	—	19.1	—	.75	—
X	4.3	4.6	.170	.180	DIA

NOTES:

- 1 POLARITY - RED DOT DENOTES CATHODE TERM

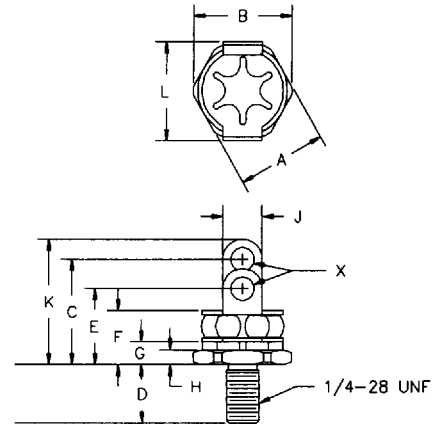

G76

DIM [#]	MM		INCHES		NOTE
	MIN	MAX	MIN	MAX	
A	5.8	7.4	.23	.29	—
B	4.5	4.8	.18	.19	—
C	3.0	3.3	.12	.13	—
D	17.7	20.4	.70	.80	—
E	2.7	3.3	.11	.13	—
F	6.0	6.6	.24	.26	—
G	1.2	1.5	.05	.06	—
H	1.0	1.3	.04	.05	1

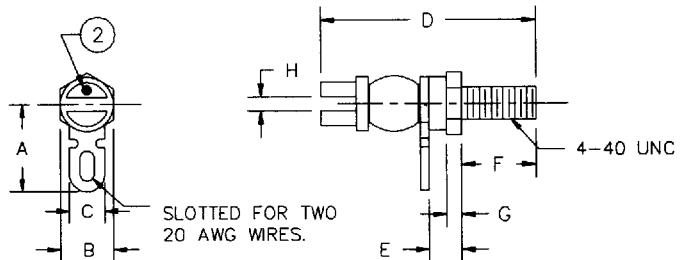

NOTES:

- 1: TERMINAL ORIENTATION NOT DEFINED.
- 2: RED DOT DENOTES CATHODE TERMINAL, BLACK DOT DENOTES ANODE TERMINAL









Looking for pricing, stock, or lifecycle information?

Click below to explore more details on WIN SOURCE:

-  [View SET010103](#) on WIN SOURCE
-  [Semtech Corporation](#) Information

Optimize Your Supply Chain with WIN SOURCE Solutions

-  Global Sourcing Solution
-  Obsolete Management
-  Cost Control Management
-  Shortage Management
-  Alternative Solution
-  Excess Inventory Management