



**THE DATASHEET OF
SF30FG-T**



SF30AG - SF30JG

3.0A SUPER-FAST GLASS PASSIVATED RECTIFIER

Features

- Glass Passivated Die Construction
- Diffused Junction
- Super-Fast Switching for High Efficiency
- Surge Overload Rating to 125A Peak
- Low Reverse Leakage Current
- **Lead Free Finish, RoHS Compliant (Note 4)**
-

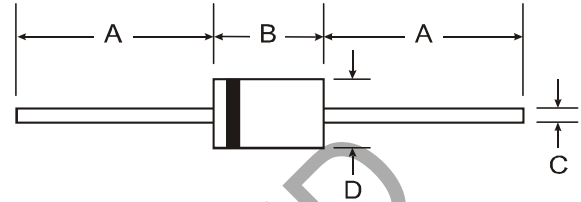

Mechanical Data

- Case: DO-201AD
- Case Material: Molded Plastic. UL Flammability Classification Rating 94V-0
- Moisture Sensitivity: Level 1 per J-STD-020C
- Terminals: Finish - Tin. Plated Leads Solderable per MIL-STD-202, Method 208 @3
- Polarity: Cathode Band
- Marking: Type Number
- Ordering Information: See Page 3
- Weight: 1.12 grams (approximate)

DO-201AD		
Dim	Min	Max
A	25.40	—
B	7.20	9.50
C	1.20	1.30
D	4.80	5.30
All Dimensions in mm		

Maximum Ratings and Electrical Characteristics @_{T_A} = 25°C unless otherwise specified

Single phase, half wave, 60Hz, resistive or inductive load.
For capacitive load, derate current by 20%.

Characteristic	Symbol	SF30 AG	SF30 BG	SF30 CG	SF30 DG	SF30 FG	SF30 GG	SF30 HG	SF30 JG	Unit
Peak Repetitive Reverse Voltage	V_{RRM}	50	100	150	200	300	400	500	600	V
Working Peak Reverse Voltage	V_{RWM}									
DC Blocking Voltage (Note 5)	V_R									
RMS Reverse Voltage	$V_{R(RMS)}$	35	70	100	140	210	280	350	420	V
Average Rectified Output Current (Note 1)	I_O	3.0								A
		@ $T_A = 55^\circ\text{C}$								
Non-Repetitive Peak Forward Surge Current	I_{FSM}	125								A
		8.3ms Single half sine-wave Superimposed on Rated Load								
Forward Voltage	V_{FM}	0.95			1.3		1.5			V
		@ $I_F = 3.0\text{A}$								
Peak Reverse Current	I_{RM}	5.0								μA
		at Rated DC Blocking Voltage (Note 5)								
		@ $T_A = 25^\circ\text{C}$								
		@ $T_A = 100^\circ\text{C}$								
Reverse Recovery Time (Note 3)	t_{rr}	35			40		50			ns
Typical Total Capacitance (Note 2)	C_T	75						50		pF
Typical Thermal Resistance Junction to Ambient	$R_{\theta JA}$	32								$^\circ\text{C/W}$
Operating and Storage Temperature Range	T_j, T_{STG}	-65 to +150								$^\circ\text{C}$

- Notes:
1. Valid provided that leads are maintained at ambient temperature at a distance of 9.5mm from the case.
 2. Measured at 1.0MHz and applied reverse voltage of 4.0V DC.
 3. Measured with $I_F = 0.5\text{A}$, $I_R = 1.0\text{A}$, $I_{rr} = 0.25\text{A}$. See figure 5.
 4. RoHS revision 13.2.2003. High temperature solder exemption applied, see *EU Directive Annex Notes 5 and 7*.
 5. Short duration pulse test used to minimize self-heating effect.

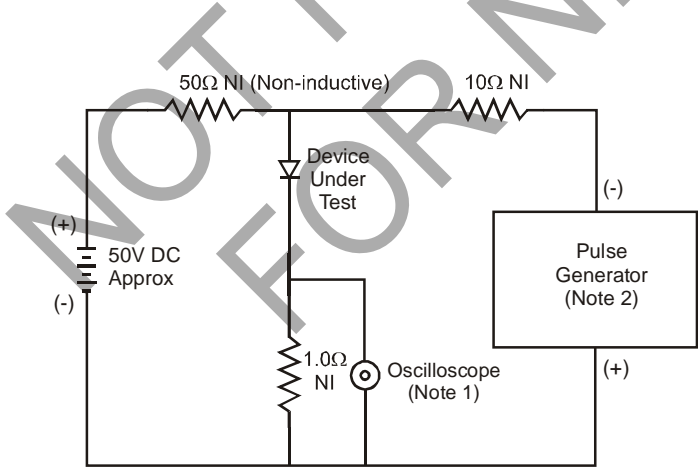
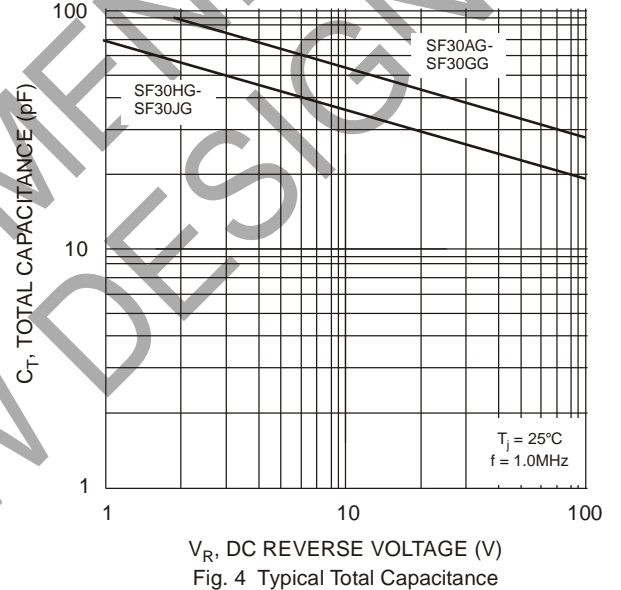
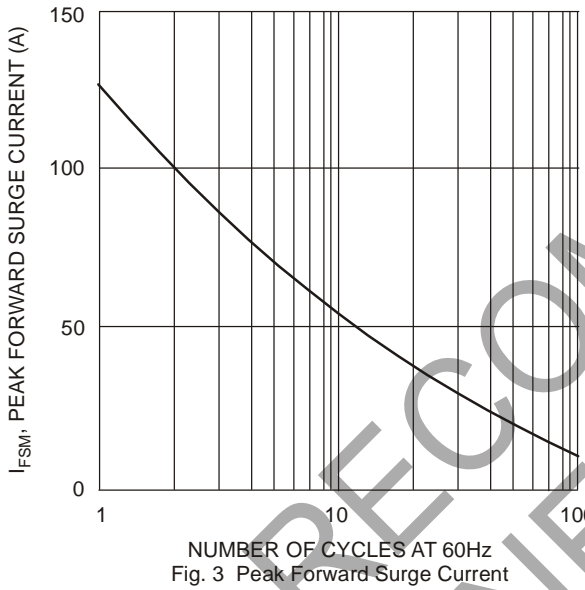
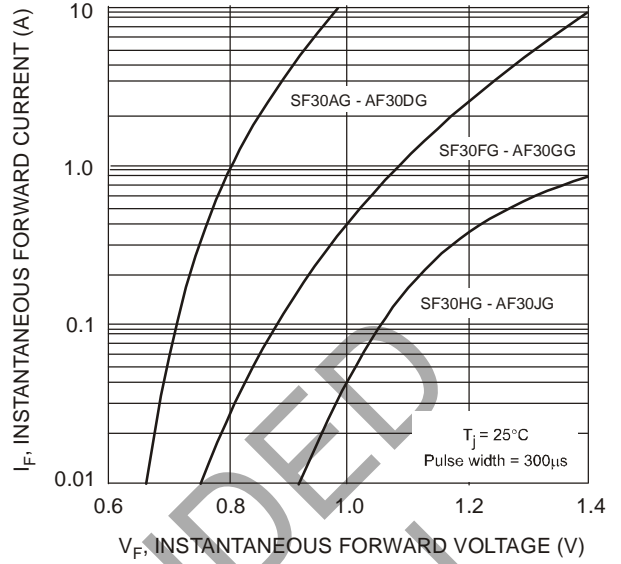
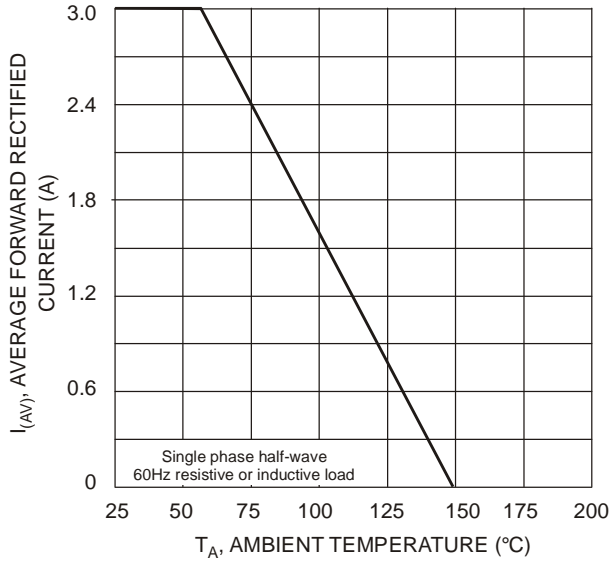

- Notes:
1. Rise Time = 7.0ns max. Input Impedance = 1.0MΩ, 22pF.
 2. Rise Time = 10ns max. Input Impedance = 50Ω.

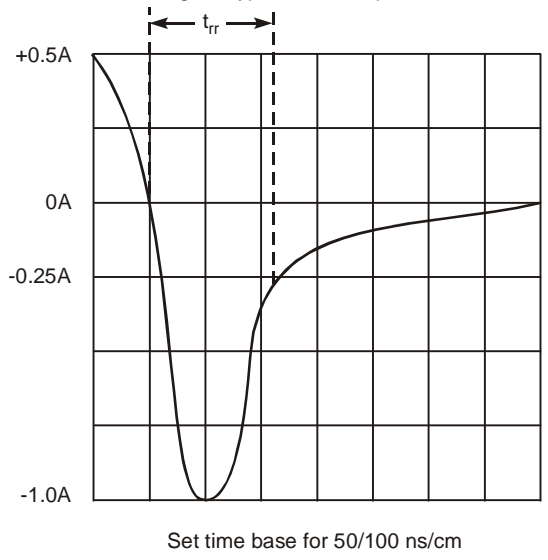

Fig. 5 Reverse Recovery Time Characteristic and Test Circuit

Ordering Information (Note 6)

Device	Packaging	Shipping
SF30AG-B	DO-201AD	500/Bulk
SF30AG-T	DO-201AD	1.2K/Tape & Reel, 13-inch
SF30BG-B	DO-201AD	500/Bulk
SF30BG-T	DO-201AD	1.2K/Tape & Reel, 13-inch
SF30CG-B	DO-201AD	500/Bulk
SF30CG-T	DO-201AD	1.2K/Tape & Reel, 13-inch
SF30DG-B	DO-201AD	500/Bulk
SF30DG-T	DO-201AD	1.2K/Tape & Reel, 13-inch
SF30FG-B	DO-201AD	500/Bulk
SF30FG-T	DO-201AD	1.2K/Tape & Reel, 13-inch
SF30GG-B	DO-201AD	500/Bulk
SF30GG-T	DO-201AD	1.2K/Tape & Reel, 13-inch
SF30HG-B	DO-201AD	500/Bulk
SF30HG-T	DO-201AD	1.2K/Tape & Reel, 13-inch
SF30JG-B	DO-201AD	500/Bulk
SF30JG-T	DO-201AD	1.2K/Tape & Reel, 13-inch

Notes: 6. For packaging details, visit our website at <http://www.diodes.com/datasheets/ap02008.pdf>.

NOT RECOMMENDED FOR NEW DESIGN

IMPORTANT NOTICE

DIODES INCORPORATED MAKES NO WARRANTY OF ANY KIND, EXPRESS OR IMPLIED, WITH REGARDS TO THIS DOCUMENT, INCLUDING, BUT NOT LIMITED TO, THE IMPLIED WARRANTIES OF MERCHANTABILITY AND FITNESS FOR A PARTICULAR PURPOSE (AND THEIR EQUIVALENTS UNDER THE LAWS OF ANY JURISDICTION).

Diodes Incorporated and its subsidiaries reserve the right to make modifications, enhancements, improvements, corrections or other changes without further notice to this document and any product described herein. Diodes Incorporated does not assume any liability arising out of the application or use of this document or any product described herein; neither does Diodes Incorporated convey any license under its patent or trademark rights, nor the rights of others. Any Customer or user of this document or products described herein in such applications shall assume all risks of such use and will agree to hold Diodes Incorporated and all the companies whose products are represented on Diodes Incorporated website, harmless against all damages.

Diodes Incorporated does not warrant or accept any liability whatsoever in respect of any products purchased through unauthorized sales channel. Should Customers purchase or use Diodes Incorporated products for any unintended or unauthorized application, Customers shall indemnify and hold Diodes Incorporated and its representatives harmless against all claims, damages, expenses, and attorney fees arising out of, directly or indirectly, any claim of personal injury or death associated with such unintended or unauthorized application.

Products described herein may be covered by one or more United States, international or foreign patents pending. Product names and markings noted herein may also be covered by one or more United States, international or foreign trademarks.

This document is written in English but may be translated into multiple languages for reference. Only the English version of this document is the final and determinative format released by Diodes Incorporated.

LIFE SUPPORT

Diodes Incorporated products are specifically not authorized for use as critical components in life support devices or systems without the express written approval of the Chief Executive Officer of Diodes Incorporated. As used herein:

A. Life support devices or systems are devices or systems which:

1. are intended to implant into the body, or
2. support or sustain life and whose failure to perform when properly used in accordance with instructions for use provided in the labeling can be reasonably expected to result in significant injury to the user.

B. A critical component is any component in a life support device or system whose failure to perform can be reasonably expected to cause the failure of the life support device or to affect its safety or effectiveness.

Customers represent that they have all necessary expertise in the safety and regulatory ramifications of their life support devices or systems, and acknowledge and agree that they are solely responsible for all legal, regulatory and safety-related requirements concerning their products and any use of Diodes Incorporated products in such safety-critical, life support devices or systems, notwithstanding any devices- or systems-related information or support that may be provided by Diodes Incorporated. Further, Customers must fully indemnify Diodes Incorporated and its representatives against any damages arising out of the use of Diodes Incorporated products in such safety-critical, life support devices or systems.

Copyright © 2015, Diodes Incorporated

www.diodes.com

Looking for pricing, stock, or lifecycle information?

Click below to explore more details on WIN SOURCE:

-  [View SF30FG-T on WIN SOURCE](#)
-  [Diodes Incorporated Information](#)

Optimize Your Supply Chain with WIN SOURCE Solutions

-  Global Sourcing Solution
-  Obsolete Management
-  Cost Control Management
-  Shortage Management
-  Alternative Solution
-  Excess Inventory Management