



THE DATASHEET OF SF1JDF-13



Product Summary (@ T_A = +25°C)

V _{RRM} (V)	I _O (A)	V _F Max (V)	I _R Max (μA)
600	1	1.7	5
400	1	1.3	5
200	1	0.98	5

Features and Benefits

- Low Profile, Small Form Factor Package
- Low Leakage Current
- Glass Passivated for High Reliability
- Superfast Recovery Times for High Efficiency
- Low Forward Voltage, Low Power Loss
- **Lead-Free Finish; RoHS Compliant (Notes 1 & 2)**
- **Halogen and Antimony Free. "Green" Device (Note 3)**

Description and Applications

The SF1xDF is a rectifier packaged in D-FLAT and is suited as a boost diode in power factor correction circuitry. For use in secondary rectification and freewheeling for superfast switching speed AC-DC and DC-DC converters in high-temperature conditions for consumer applications.

- DC-DC Converters
- AC-DC Adaptors/Chargers
- Inverters

Mechanical Data

- Case: D-FLAT
- Case Material: Molded Plastic, "Green" Molding Compound. UL Flammability Classification Rating 94V-0
- Moisture Sensitivity: Level 1 per J-STD-020
- Terminals: Matte Tin Finish Annealed over Copper Leadframe. Solderable per MIL-STD-202, Method 208
- Polarity: Cathode Band
- Weight: 0.062 grams (Approximate)

D-FLAT



Top View

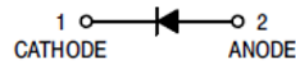

Schematic View

Ordering Information (Note 4)

Part Number	Qualification	Case	Packaging
SF1JDF-13	Commercial	D-FLAT	10,000/Tape & Reel
SF1GDF-13	Commercial	D-FLAT	10,000/Tape & Reel
SF1DDF-13	Commercial	D-FLAT	10,000/Tape & Reel

- Notes:
1. EU Directive 2002/95/EC (RoHS), 2011/65/EU (RoHS 2) & 2015/863/EU (RoHS 3) compliant. All applicable RoHS exemptions applied.
 2. See <https://www.diodes.com/quality/lead-free/> for more information about Diodes Incorporated's definitions of Halogen- and Antimony-free, "Green" and Lead-free.
 3. Halogen- and Antimony-free "Green" products are defined as those which contain <900ppm bromine, <900ppm chlorine (<1500ppm total Br + Cl) and <1000ppm antimony compounds.
 4. For packaging details, go to our website at <http://www.diodes.com/products/packages.html>.

Marking Information

D-FLAT

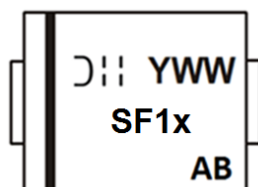

SF1x = Product Type Marking Code (ie. SF1J for SF1JDF, SF1G for SF1GDF, SF1D for SF1DDF)
 = Manufacturers' Code Marking
 YWW = Date Code Marking
 Y = Last Digit of Year (ex: 6 for 2016)
 WW = Week Code (01 to 53)
 AB = Foundry and Assembly Code

Maximum Ratings and Electrical Characteristics (@T_A = +25°C unless otherwise specified.)

Single phase, half wave, 60Hz, resistive or inductive load.
For capacitive load, derate current by 20%.

Characteristic	Symbol	SF1DDF	SF1GDF	SF1JDF	Unit
Peak Repetitive Reverse Voltage	V _{RRM}	200	400	600	V
Working Peak Reverse Voltage	V _{RWM}				
DC Blocking Voltage	V _R				
Average Rectified Output Current @T _T = +110°C (Note 5)	I _O	1.0			A
Non-Repetitive Peak Forward Surge Current 8.3ms Single Half Sine-Wave Superimposed on Rated Load	I _{FSM}	30			A
Maximum Instantaneous Forward Voltage @ I _F = 1A	V _F	0.98	1.3	1.7	V
Maximum DC Reverse Current @ T _A = +25°C at Rated DC Blocking Voltage @ T _A = +100°C (Note 7)	I _R	5 100			μA
Typical Total Capacitance (Note 8)	C _T	20			pF
Maximum Reverse Recovery Time (Note 9)	t _{RR}	35			ns

Thermal Characteristics

Characteristic	Symbol	Value	Unit
Typical Thermal Resistance Junction to Terminal (Note 6)	R _{θJT}	36	°C/W
Typical Thermal Resistance Junction to Ambient (Note 6)	R _{θJA}	87	°C/W
Operating and Storage Temperature Range	T _J , T _{STG}	-55 to +150	°C

- Notes:
5. Device mounted on FR-4 substrate, 1" x 1", 2oz, single-sided, PCBs with 0.1" x 0.15" copper pad.
 6. Device mounted on FR-4 substrate, 0.4" x 0.5", 2oz, single-sided, PC boards with 0.2" x 0.25" copper pad.
 7. Short duration pulse test used to minimize self-heating effect.
 8. Measured at 1.0MHz and applied reverse voltage of 4.0V DC.
 9. Measured with I_F = 0.5A, I_R = 1A, I_{RR} = 0.25A.

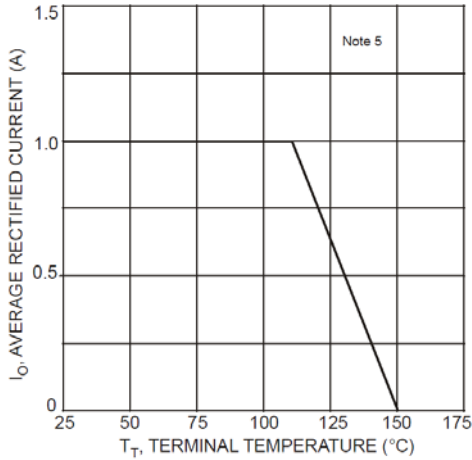

Fig. 1 Forward Current Derating Curve

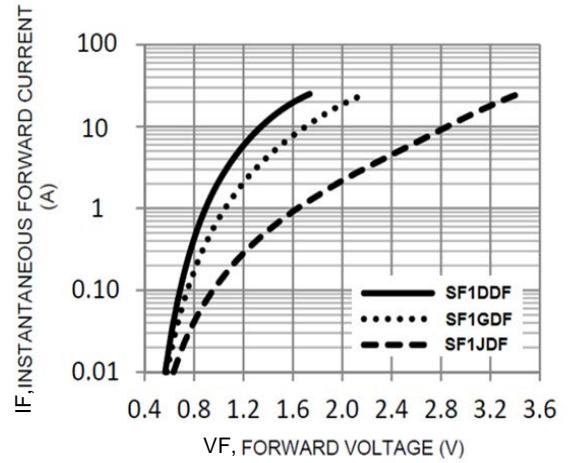

Fig. 2. Typical Forward Characteristics

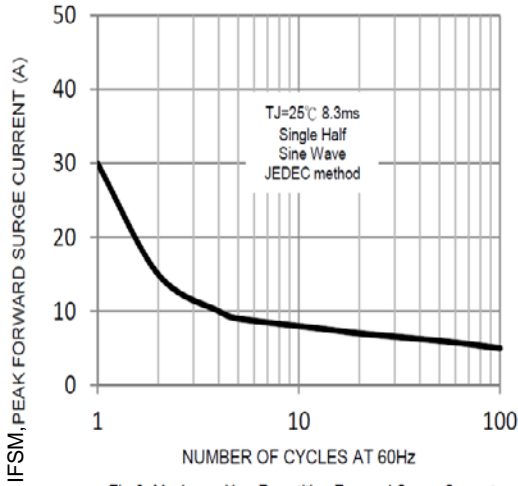

Fig 3. Maximum Non-Repetitive Forward Surge Current

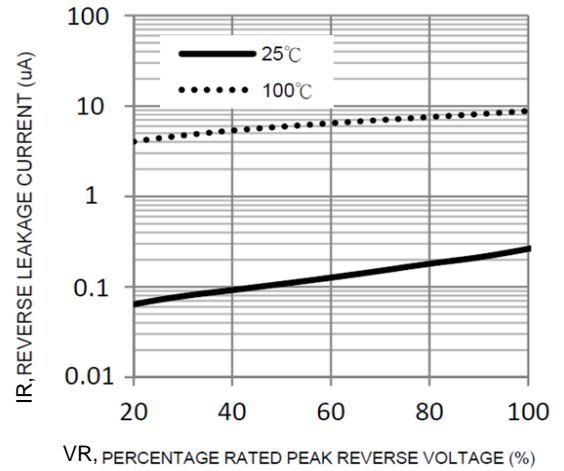

Fig 4. Typical Reverse Characteristics

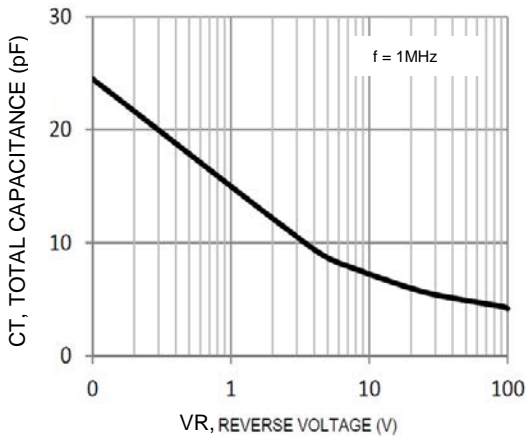

Fig 5. Typical Total Capacitance

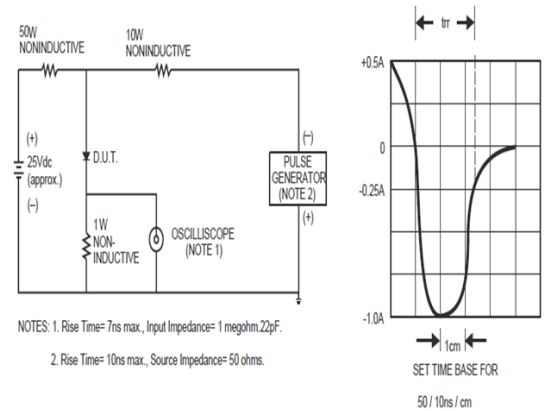
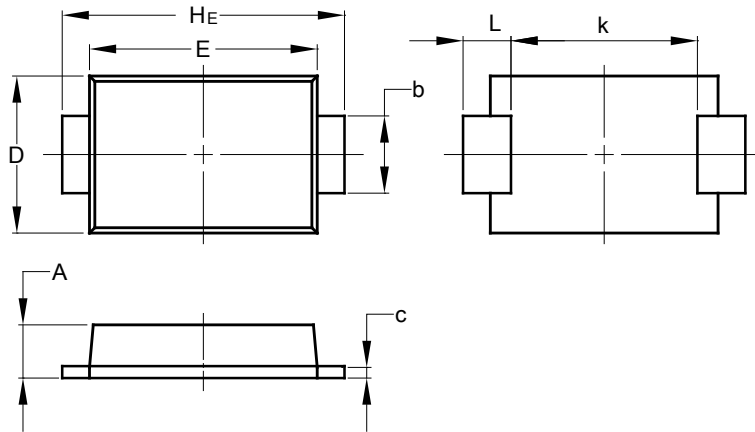

Fig 6. Reverse Recovery Time Characteristic and Test Circuit

Package Outline Dimensions

Please see <http://www.diodes.com/package-outlines.html> for the latest version.

D-FLAT



D-FLAT		
Dim	Min	Max
A	0.90	1.10
b	1.25	1.65
c	0.10	0.40
D	2.25	2.95
E	3.95	4.60
k	2.80	-
HE	5.00	5.60
L	0.50	1.30
All Dimensions in mm		

Suggested Pad Layout

Please see <http://www.diodes.com/package-outlines.html> for the latest version.

D-FLAT

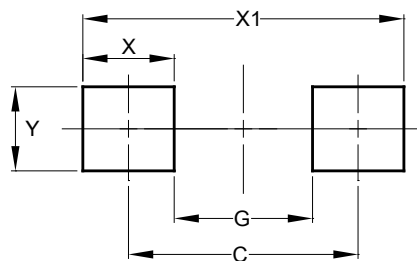

Dimensions	Value (in mm)
C	4.65
G	2.80
X	1.85
X1	6.50
Y	1.70

IMPORTANT NOTICE

DIODES INCORPORATED MAKES NO WARRANTY OF ANY KIND, EXPRESS OR IMPLIED, WITH REGARDS TO THIS DOCUMENT, INCLUDING, BUT NOT LIMITED TO, THE IMPLIED WARRANTIES OF MERCHANTABILITY AND FITNESS FOR A PARTICULAR PURPOSE (AND THEIR EQUIVALENTS UNDER THE LAWS OF ANY JURISDICTION).

Diodes Incorporated and its subsidiaries reserve the right to make modifications, enhancements, improvements, corrections or other changes without further notice to this document and any product described herein. Diodes Incorporated does not assume any liability arising out of the application or use of this document or any product described herein; neither does Diodes Incorporated convey any license under its patent or trademark rights, nor the rights of others. Any Customer or user of this document or products described herein in such applications shall assume all risks of such use and will agree to hold Diodes Incorporated and all the companies whose products are represented on Diodes Incorporated website, harmless against all damages.

Diodes Incorporated does not warrant or accept any liability whatsoever in respect of any products purchased through unauthorized sales channel. Should Customers purchase or use Diodes Incorporated products for any unintended or unauthorized application, Customers shall indemnify and hold Diodes Incorporated and its representatives harmless against all claims, damages, expenses, and attorney fees arising out of, directly or indirectly, any claim of personal injury or death associated with such unintended or unauthorized application.

Products described herein may be covered by one or more United States, international or foreign patents pending. Product names and markings noted herein may also be covered by one or more United States, international or foreign trademarks.

This document is written in English but may be translated into multiple languages for reference. Only the English version of this document is the final and determinative format released by Diodes Incorporated.

LIFE SUPPORT

Diodes Incorporated products are specifically not authorized for use as critical components in life support devices or systems without the express written approval of the Chief Executive Officer of Diodes Incorporated. As used herein:

A. Life support devices or systems are devices or systems which:

1. are intended to implant into the body, or
2. support or sustain life and whose failure to perform when properly used in accordance with instructions for use provided in the labeling can be reasonably expected to result in significant injury to the user.

B. A critical component is any component in a life support device or system whose failure to perform can be reasonably expected to cause the failure of the life support device or to affect its safety or effectiveness.



Customers represent that they have all necessary expertise in the safety and regulatory ramifications of their life support devices or systems, and acknowledge and agree that they are solely responsible for all legal, regulatory and safety-related requirements concerning their products and any use of Diodes Incorporated products in such safety-critical, life support devices or systems, notwithstanding any devices- or systems-related information or support that may be provided by Diodes Incorporated. Further, Customers must fully indemnify Diodes Incorporated and its representatives against any damages arising out of the use of Diodes Incorporated products in such safety-critical, life support devices or systems.

Copyright © 2018, Diodes Incorporated

www.diodes.com

Looking for pricing, stock, or lifecycle information?

Click below to explore more details on WIN SOURCE:

-  [View SF1JDF-13 on WIN SOURCE](#)
-  [Diodes Incorporated Information](#)

Optimize Your Supply Chain with WIN SOURCE Solutions

-  Global Sourcing Solution
-  Obsolete Management
-  Cost Control Management
-  Shortage Management
-  Alternative Solution
-  Excess Inventory Management