



**THE DATASHEET OF  
SD101CW-13**



## Features

- Low Forward Voltage Drop
- Guard Ring Construction for Transient Protection
- Negligible Reverse Recovery Time
- Very Low Reverse Capacitance
- **Lead, Halogen and Antimony Free, RoHS Compliant "Green" Device (Notes 2 and 3)**

## Mechanical Data

- Case: SOD-123
- Case Material: Molded Plastic. UL Flammability Classification Rating 94V-0
- Moisture Sensitivity: Level 1 per J-STD-020D
- Leads: Solderable per MIL-STD-202, Method 208
- Lead Free Plating (Matte Tin Finish annealed over Alloy 42 leadframe)
- Polarity: Cathode Band
- Marking Information: See Page 3
- Ordering Information: See Page 3
- Weight: 0.01 grams (approximate)



Top View

## Maximum Ratings @ $T_A = 25^\circ\text{C}$ unless otherwise specified

Characteristic	Symbol	SD101AW	SD101BW	SD101CW	Unit
Peak Repetitive Reverse Voltage	$V_{RRM}$				
Working Peak Reverse Voltage	$V_{RWM}$	60	50	40	V
DC Blocking Voltage	$V_R$				
RMS Reverse Voltage	$V_{R(RMS)}$	42	35	28	V
Forward Continuous Current (Note 1)	$I_{FM}$		15		mA
Non-Repetitive Peak Forward Surge Current	@ $t \leq 1.0\text{s}$		50		mA
	@ $t = 10\mu\text{s}$		2.0		A

## Thermal Characteristics

Characteristic	Symbol	Value	Unit
Power Dissipation (Note 1)	$P_D$	400	mW
Thermal Resistance, Junction to Ambient Air (Note 1)	$R_{\theta JA}$	300	$^\circ\text{C/W}$
Operating and Storage Temperature Range	$T_J, T_{STG}$	-65 to +125	$^\circ\text{C}$

- Notes:
1. Part mounted on FR-4 board with recommended pad layout, which can be found on our website at <http://www.diodes.com/datasheets/ap02001.pdf>.
  2. No purposefully added lead. Halogen and Antimony Free.
  3. Product manufactured with Data Code V9 (week 33, 2008) and newer are built with Green Molding Compound. Product manufactured prior to Date Code V9 are built with Non-Green Molding Compound and may contain Halogens or  $\text{Sb}_2\text{O}_3$  Fire Retardants.

**Electrical Characteristics** @T<sub>A</sub> = 25°C unless otherwise specified

Characteristic		Symbol	Min	Max	Unit	Test Condition
Reverse Breakdown Voltage (Note 4)	SD101AW SD101BW SD101CW	V <sub>(BR)R</sub>	60 50 40	—	V	I <sub>R</sub> = 10μA I <sub>R</sub> = 10μA I <sub>R</sub> = 10μA
Forward Voltage Drop	SD101AW SD101BW SD101CW SD101AW SD101BW SD101CW	V <sub>FM</sub>	—	0.41 0.40 0.39 1.00 0.95 0.90	V	I <sub>F</sub> = 1.0mA I <sub>F</sub> = 1.0mA I <sub>F</sub> = 1.0mA I <sub>F</sub> = 15mA I <sub>F</sub> = 15mA I <sub>F</sub> = 15mA
Peak Reverse Current (Note 4)	SD101AW SD101BW SD101CW	I <sub>RM</sub>	—	200	nA	V <sub>R</sub> = 50V V <sub>R</sub> = 40V V <sub>R</sub> = 30V
Total Capacitance	SD101AW SD101BW SD101CW	C <sub>T</sub>	—	2.0 2.1 2.2	pF	V <sub>R</sub> = 0V, f = 1.0MHz
Reverse Recovery Time		t <sub>rr</sub>	—	1.0	ns	I <sub>F</sub> = I <sub>R</sub> = 5.0mA, I <sub>rr</sub> = 0.1 x I <sub>R</sub> , R <sub>L</sub> = 100Ω

Notes: 4. Short duration pulse test used to minimize self-heating effect.

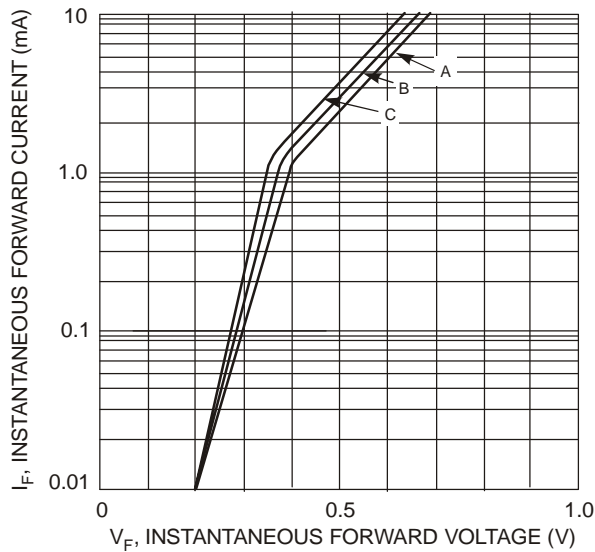

Fig. 1 Typical Forward Characteristics

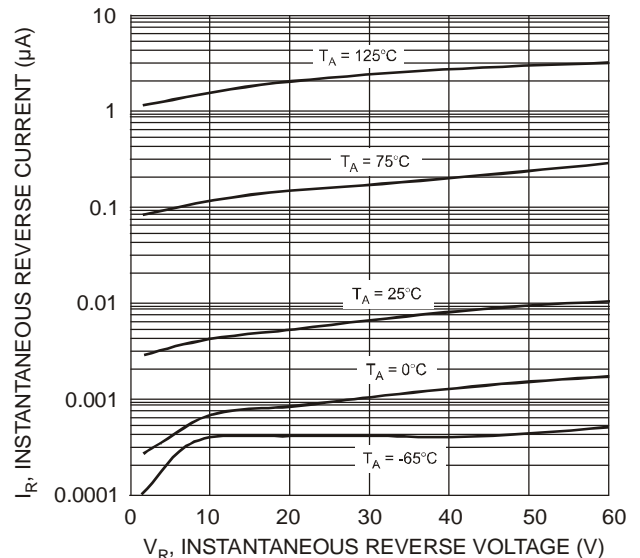

Fig. 2 Typical Reverse Characteristics

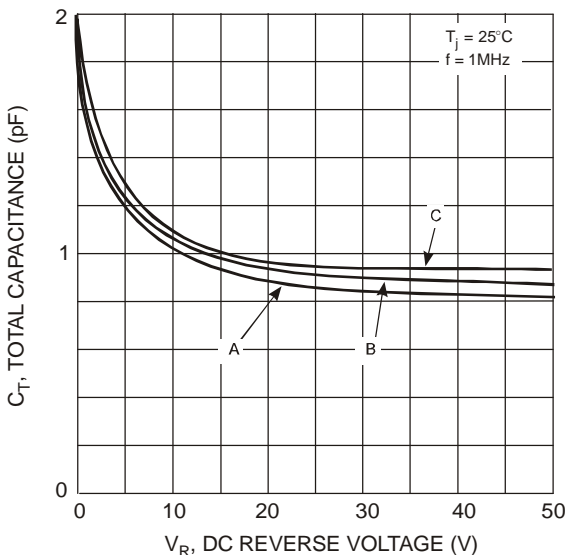

Fig. 3 Total Capacitance vs Reverse Voltage

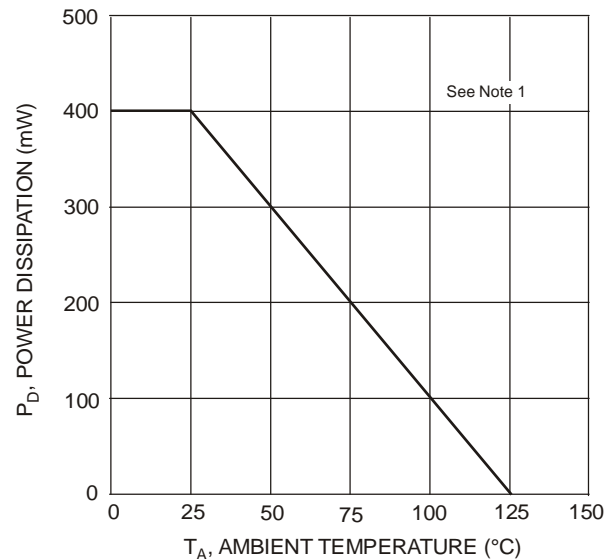

Fig. 4 Power Derating Curve

### Ordering Information (Note 5)

Part Number	Case	Packaging
SD101xW-7-F	SOD-123	3000/Tape and Reel
SD101xW-13-F	SOD-123	10,000/Tape and Reel

Notes: 5. For packaging details, go to our website at <http://www.diodes.com/datasheets/ap02007.pdf>.

### Marking Information



xx = Product Type Marking Code  
 S1 or SK = SD101AW  
 S2 or SK = SD101BW  
 S3 or SK = SD101CW  
 YM = Date Code Marking  
 Y = Year (ex: T = 2006)  
 M = Month (ex: 9 = September)

#### Date Code Key

Year	1998	1999	2000	2001	2002	2003	2004	2005	2006	2007	2008	2009	2010	2011	2012	2013	2014	2015
Code	J	K	L	M	N	P	R	S	T	U	V	W	X	Y	Z	A	B	C

Month	Jan	Feb	Mar	Apr	May	Jun	Jul	Aug	Sep	Oct	Nov	Dec
Code	1	2	3	4	5	6	7	8	9	O	N	D

### Package Outline Dimensions

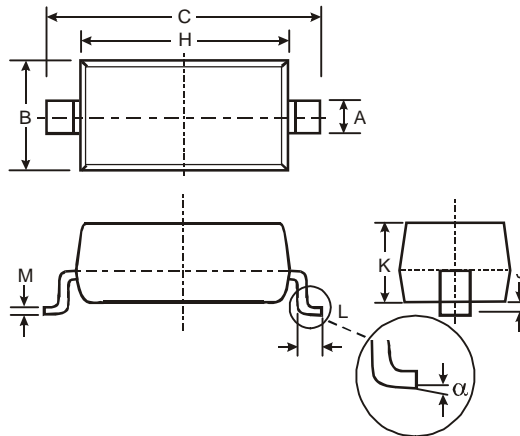

SOD-123		
Dim	Min	Max
A	0.55 Typ	
B	1.40	1.70
C	3.55	3.85
H	2.55	2.85
J	0.00	0.10
K	1.00	1.35
L	0.25	0.40
M	0.10	0.15
$\alpha$	0	8°
All Dimensions in mm		

### Suggested Pad Layout

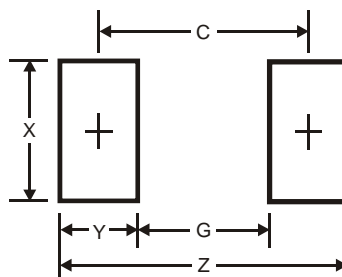

Dimensions	Value (in mm)
Z	4.9
G	2.5
X	0.7
Y	1.2
C	3.7

#### IMPORTANT NOTICE



Diodes Incorporated and its subsidiaries reserve the right to make modifications, enhancements, improvements, corrections or other changes without further notice to any product herein. Diodes Incorporated does not assume any liability arising out of the application or use of any product described herein; neither does it convey any license under its patent rights, nor the rights of others. The user of products in such applications shall assume all risks of such use and will agree to hold Diodes Incorporated and all the companies whose products are represented on our website, harmless against all damages.

#### LIFE SUPPORT

Diodes Incorporated products are not authorized for use as critical components in life support devices or systems without the expressed written approval of the President of Diodes Incorporated.

## Looking for pricing, stock, or lifecycle information?

Click below to explore more details on WIN SOURCE:

-  [View SD101CW-13 on WIN SOURCE](#)
-  [Diodes Incorporated Information](#)

## Optimize Your Supply Chain with WIN SOURCE Solutions

-  Global Sourcing Solution
-  Obsolete Management
-  Cost Control Management
-  Shortage Management
-  Alternative Solution
-  Excess Inventory Management