

Features

- Glass Passivated Die Construction
- Low Forward Voltage Drop and High Current Capability
- Surge Overload Rating to 50A Peak
- Ideally Suited for Automated Assembly
- Available in Lead Free Finish/RoHS Compliant Version (Note 3)

Mechanical Data

- Case: SMA/SMB
- Case Material: Molded Plastic. UL Flammability Classification Rating 94V-0
- Moisture Sensitivity: Level 1 per J-STD-020C
- Also Available in Lead Free Plating (Matte Tin Finish). Please see Ordering Information, Note 5, on Page 2
- Polarity: Cathode Band or Cathode Notch
- Marking: Type Number, See Page 2
- Ordering Information: See Page 2
- Approx. Weight: SMA 0.064 grams
SMB 0.093 grams

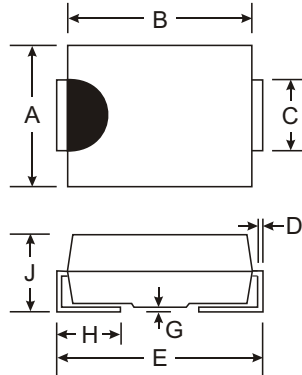

Dim	SMA		SMB	
	Min	Max	Min	Max
A	2.29	2.92	3.30	3.94
B	4.00	4.60	4.06	4.57
C	1.27	1.63	1.96	2.21
D	0.15	0.31	0.15	0.31
E	4.80	5.59	5.00	5.59
G	0.10	0.20	0.10	0.20
H	0.76	1.52	0.76	1.52
J	2.01	2.62	2.00	2.62
All Dimensions in mm				

A Suffix Designates SMA Package
No Suffix Designates SMB Package

@T_A = 25°C unless otherwise specified

Maximum Ratings and Electrical Characteristics

Single phase, half wave, 60Hz, resistive or inductive load.
For capacitive load, derate current by 20%.

Characteristic	Symbol	S2 A/AA	S2 B/BA	S2 D/DA	S2 G/GA	S2 J/JA	S2 K/KA	S2 M/MA	Unit
Peak Repetitive Reverse Voltage Working Peak Reverse Voltage DC Blocking Voltage	V _{RRM} V _{RWM} V _R	50	100	200	400	600	800	1000	V
RMS Reverse Voltage	V _{R(RMS)}	35	70	140	280	420	560	700	V
Average Rectified Output Current @ T _T = 100°C	I _(AV)	1.5							A
Non-Repetitive Peak Forward Surge Current 8.3ms single half sine-wave superimposed on rated load (JEDEC Method)	I _{FSM}	50							A
Forward Voltage @ I _F = 1.5A	V _{FM}	1.15							V
Peak Reverse Current @ T _A = 25°C at Rated DC Blocking Voltage @ T _A = 125°C	I _{RM}	5.0 125							μA
Typical Total Capacitance (Note 1)	C _T	20							pF
Typical Thermal Resistance, Junction to Terminal (Note 2)	R _{θJT}	20							°C/W
Operating and Storage Temperature Range	T _j , T _{STG}	-65 to +150							°C

- Notes:
1. Measured at 1.0 MHz and applied reverse voltage of 4.0V DC.
 2. Thermal Resistance Junction to Terminal, unit mounted on PC board with 5.0 mm² (0.013 mm thick) copper pads as heat sink.
 3. RoHS revision 13.2.2003. Glass and High Temperature Solder Exemptions Applied, see EU Directive Annex Notes 5 and 7.

Ordering Information (Note 4)

Device*	Packaging	Shipping
S2xA-13 S2X-13	SMA SMB	5000/Tape & Reel 3000/Tape & Reel

* x = Device type, e.g. S2AA-13 (SMA package); S2A-13 (SMB package).

- Notes: 4. For Packaging Details, go to our website at <http://www.diodes.com/datasheets/ap02007.pdf>.
5. For Lead Free Finish/RoHS Compliant version part number, please add "-F" suffix to the part number above. Example: S2A-13-F.

Marking Information

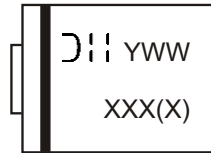

XXX = Product type marking code, ex: S2A (SMB package)
 XXXX = Product type marking code, ex: S2AA (SMA package)
 D; ; = Manufacturers' code marking
 YWW = Date code marking
 Y = Last digit of year ex: 2 for 2002
 WW = Week code 01 to 52

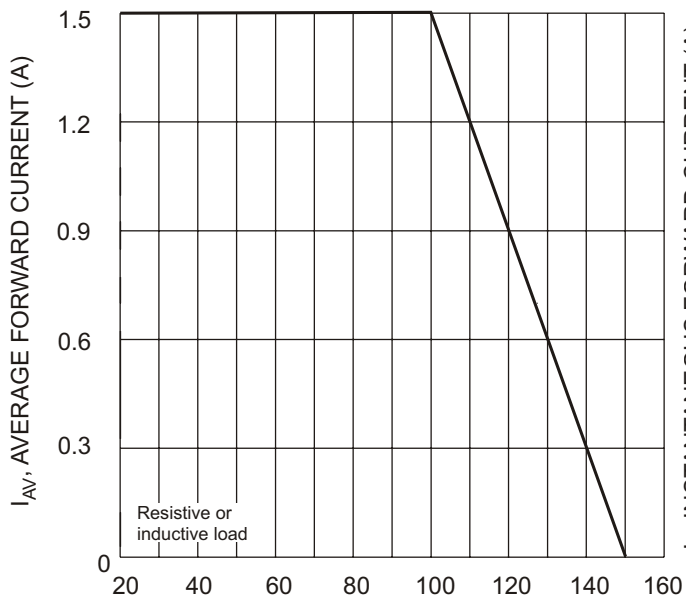

T_T , TERMINAL TEMPERATURE (°C)
Fig. 1 Forward Current Derating Curve

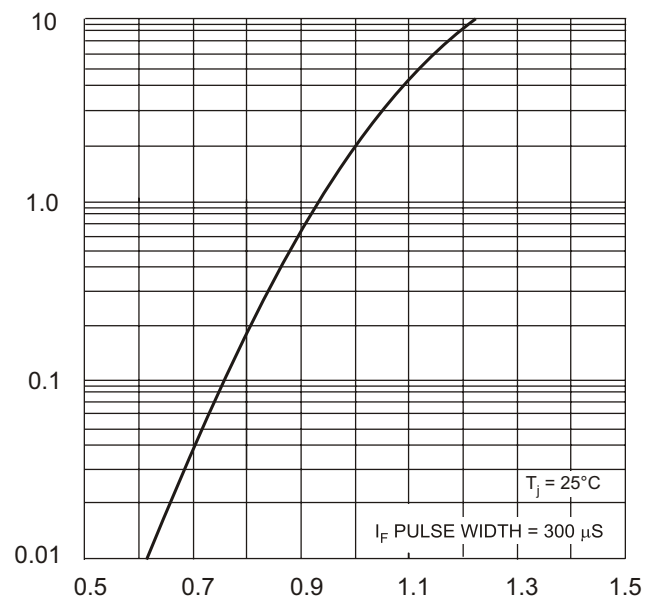

V_F , INSTANTANEOUS FORWARD VOLTAGE (V)
Fig. 2 Typical Forward Characteristics

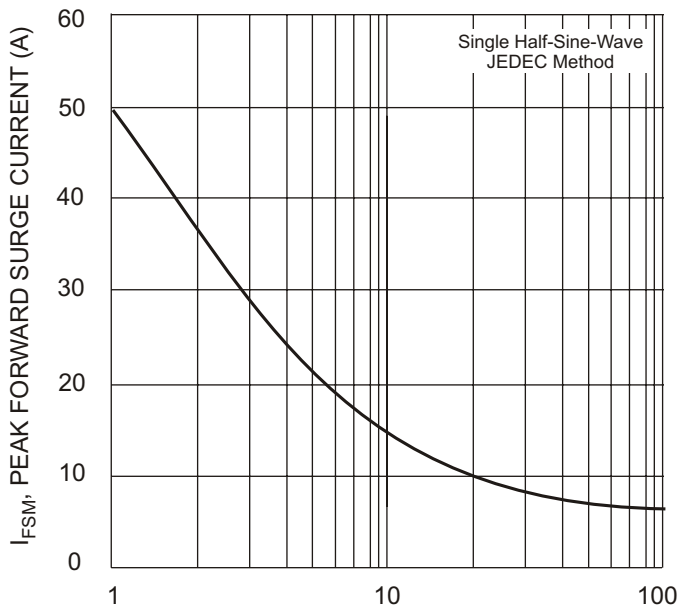

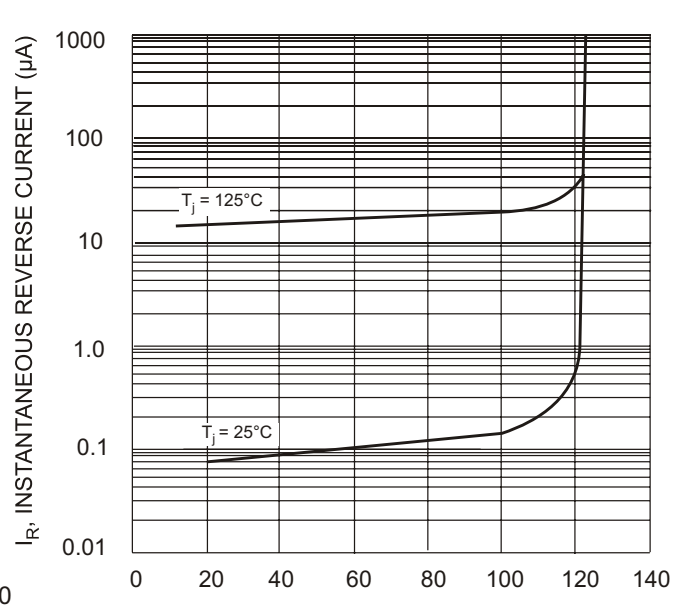

NUMBER OF CYCLES AT 60 Hz
Fig. 3 Forward Surge Current Derating Curve



PERCENT OF RATED PEAK REVERSE VOLTAGE (%)
Fig. 4 Typical Reverse Characteristics

Looking for pricing, stock, or lifecycle information?

Click below to explore more details on WIN SOURCE:

-  [View S2KA-13 on WIN SOURCE](#)
-  [Diodes Incorporated Information](#)

Optimize Your Supply Chain with WIN SOURCE Solutions

-  Global Sourcing Solution
-  Obsolete Management
-  Cost Control Management
-  Shortage Management
-  Alternative Solution
-  Excess Inventory Management