

3.3V PECL Low Jitter XO

SN

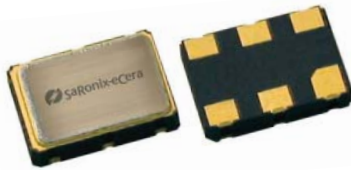

7.0 x 5.0mm Ceramic SMD

Product Features

- 50 to 220 MHz Frequency Range
- <1 ps RMS jitter with advanced non-PLL, patented design (U.S. Patent #7002423)
- Thicker crystal for improved reliability
- RoHS compliant

Product Description

The SN Series 3.3V crystal clock oscillator achieves superb jitter and stability over a broad range of operating conditions and frequencies. The output clock signal, generated internally with a patented oscillator design, is compatible with LVPECL logic levels. The device, available on tape and reel, is contained in a 7.0 x 5.0mm surface-mount ceramic package.

Applications

The SN Series is an ideal reference clock for high-speed applications requiring low jitter, including:

- 1/10 Gigabit Ethernet
- 2/4/10G Fibre Channel
- Serial Attached SCSI (SAS)
- Server & Storage platforms
- SONET/SDH linecards
- Passive Optical Network (PON) devices
- HD Video Systems

Package:

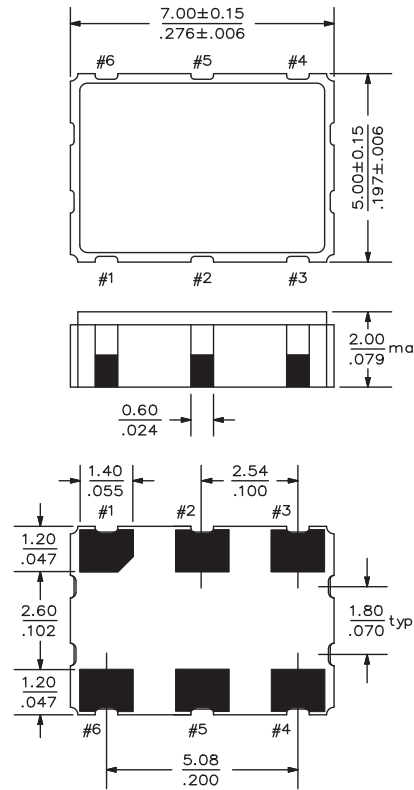

Recommended Land Pattern:

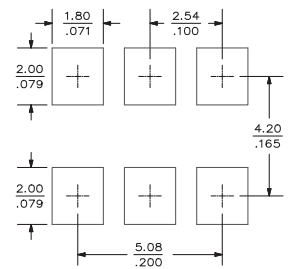

Pin Functions:

| Pin | Function |
|-----|------------------|
| 1 | OE or NC |
| 2 | OE or NC |
| 3 | V _{EE} |
| 4 | Q Output |
| 5 | \bar{Q} Output |
| 6 | V _{CC} |

Part Ordering Information:

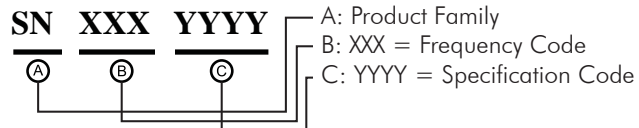

Following the above format, Saronix-eCera part numbers will be assigned upon confirmation of exact customer requirements.

Legacy Ordering Information - For Reference Only:

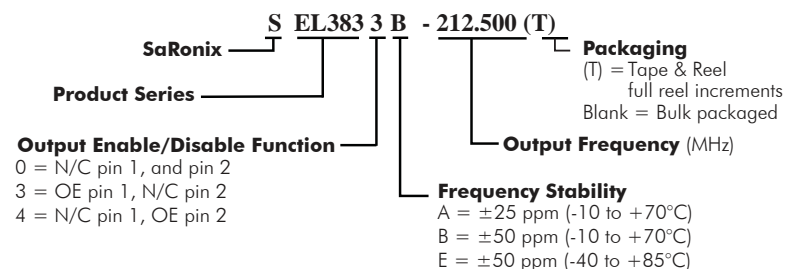

Electrical Performance

| Parameter | Min. | Typ. | Max. | Units | Notes |
|---------------------------------|-----------------------------|------|-------------------------|--------------|---------------------------------|
| Output Frequency | 50 | | 220 | MHz | As specified |
| Supply Voltage | 2.97 | 3.30 | 3.63 | V | |
| Supply Current, Output Enabled | | 60 | 70 | mA | |
| Supply Current, Output Disabled | | | 25 | μA | |
| Frequency Stability | | | ±20 to ±50 | ppm | See Note 1 below |
| Operating Temperature Range | -20 | | +70 | °C | Commercial (standard) |
| | -40 | | +85 | | Industrial (standard) |
| Output Logic 0, V _{OL} | | | V _{CC} - 1.620 | V | 0 to +85°C |
| | | | V _{CC} - 1.555 | V | -40 to 0°C |
| Output Logic 1, V _{OH} | V _{CC} - 1.025 | | | V | 0 to +85°C |
| | V _{CC} - 1.085 | | | V | -40 to +0°C |
| Output Load | 50Ω to V _{CC} - 2V | | | | output requires termination |
| Duty Cycle | 45 | | 55 | % | Measured 50% V _{DD} |
| Rise and Fall Time | | 500 | 850 | ns | Measured 20/80% of waveform |
| Jitter, Phase | | 0.25 | 1 | ps RMS (1-σ) | 12 kHz to 20 MHz frequency band |
| Jitter, Total | | 25 | 40 | ps pk-pk | 1000 random periods |

Notes:

- Stability includes all combinations of operating temperature, load changes, rated input (supply) voltage changes, initial calibration tolerance (25°C), aging (5 year at 40°C average effective ambient temperature), shock and vibration.
- For specifications other than those listed, please contact sales.

Output Enable / Disable Function

| Parameter | Min. | Typ. | Max. | Units | Notes |
|--|------|------|------|-------|--------------------------|
| Input Voltage (pin OE), Output Enable | 2.2 | | | V | or open |
| Input Voltage (pin OE), Output Disable (low power standby) | | | 0.8 | V | Outputs disabled to Hi-Z |
| Internal Pullup Resistance | 50 | | | kΩ | |
| Output Disable Delay | | | 200 | ns | |
| Output Enable Delay | | | 10 | ms | |

Absolute Maximum Ratings

| Parameter | Min. | Typ. | Max. | Units | Notes |
|---------------------|------|------|------|-------|-------|
| Storage Temperature | -55 | | +125 | °C | |

Typical Phase Noise

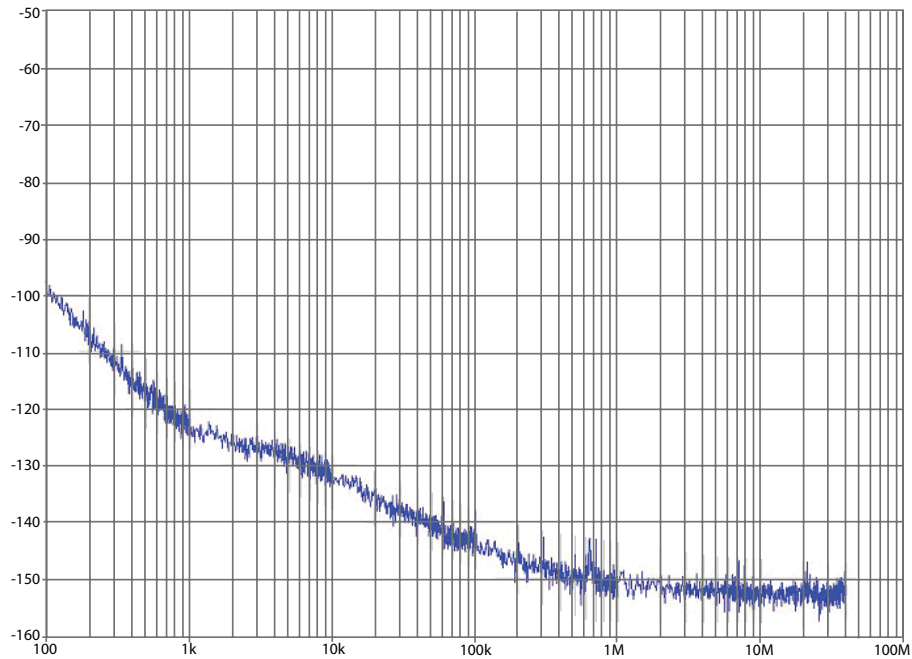

Test Circuit

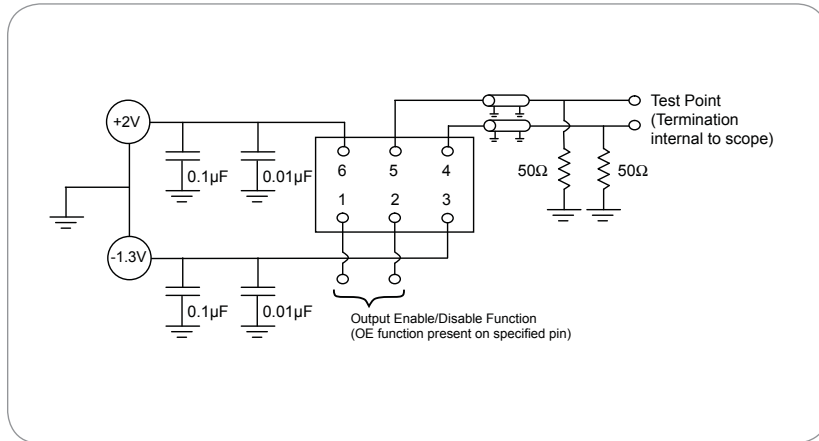

Reflow Soldering Profile

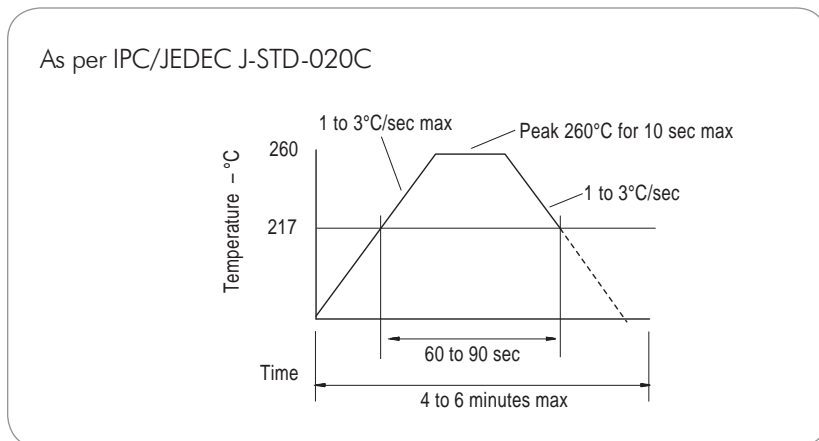

Reliability Test Ratings

This product is rated to meet the following test conditions:

| Type | Parameter | Test Condition |
|---------------|------------------------------|---|
| Mechanical | Shock | MIL-STD-883, Method 2002, Condition B |
| Mechanical | Solderability | JESD22-B102-D Method 2 (Preconditioning E) |
| Mechanical | Terminal strength | MIL-STD-883, Method 2004, Condition D |
| Mechanical | Gross leak | MIL-STD-883, Method 1014, Condition C |
| Mechanical | Fine leak | MIL-STD-883, Method 1014, Condition A2 ($R_1 = 2 \times 10^{-8}$ atm cc/s) |
| Mechanical | Solvent resistance | MIL-STD-202, Method 215 |
| Environmental | Thermal shock | MIL-STD-883, Method 1011, Condition A |
| Environmental | Moisture resistance | MIL-STD-883, Method 1004 |
| Environmental | Vibration | MIL-STD-883, Method 2007, Condition A |
| Environmental | Resistance to soldering heat | J-STD-020C Table 5-2 Pb-free devices (2 cycles max) |

Looking for pricing, stock, or lifecycle information?

Click below to explore more details on WIN SOURCE:

 [View SNL250004 on WIN SOURCE](#)

 [Diodes Incorporated](#) Information

Optimize Your Supply Chain with WIN SOURCE Solutions

-  Global Sourcing Solution
-  Obsolete Management
-  Cost Control Management
-  Shortage Management
-  Alternative Solution
-  Excess Inventory Management