



**THE DATASHEET OF
SL1411A600C**



SL1011A and SL1411A Series



Description

The SL1011A and SL1411A series provides high levels of protection against fast rising transients in the 100V/μs to 1kV/μs range usually caused by lightning disturbances.

The SL1011A and SL1411A series offers low capacitance (< 1.5pf) which provides low insertion loss at high frequencies.

SL1011A offers 5kA protection without destruction whereas the SL1411A offer 10kA surge protection without destruction (maximum single surge of 12kA @ 8/20μs).

Agency Approvals

Agency	Agency File Number
	E128662

Features

- Lead-free and RoHS compliant
- Low insertion loss
- Excellent response to fast rising transients
- Ultra low capacitance
- 5kA (SL1011A) or 10kA (SL1411A) surge capability tested with 8/20μs pulse as defined by IEC 61000-4-5 2nd Edition

2 Electrode GDT Graphical Symbol

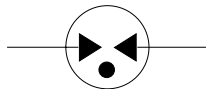

Applications

- Broadband equipment
- ADSL equipment
- XDSL equipment
- Satellite and CATV equipment
- General telecom equipment

Additional Information



Datasheet
SL1011A



Resources
SL1011A



Samples
SL1011A



Datasheet
SL1411A



Resources
SL1411A



Samples
SL1411A

Electrical Characteristics

Part Number	Device Specifications (at 25°C)						Life Ratings														
	DC Breakdown in Volts ^{1,2} (@100V/s)			Impulse Breakdown in Volts ³ (@100V/μs)	Impulse Breakdown In Volts (@1kV/μs)	Insulation Resistance	Capacitance (@1MHz)	Arc Voltage (on state Voltage) @ 1Amp Min	Surge Life (@100A 10/1000μs)	Nominal Impulse Discharge Current (8/20μs)	Nominal AC Discharge Current (10x1s @50-60Hz)	AC Discharge Current (9 Cycles @ 50Hz)	DC Holdover Voltage ⁴	Max Impulse Discharge Current (1 Application)							
	MIN	TYP	MAX	MAX		MIN	MAX	TYP					TYP	@ 8/20μs	@ 10/350μs						
SL1011A075 SL1411A075	60	75	90	500	700	10 ¹⁰ Ω (at 50V)	1.5 pF	~20 V	300 shots	SL1011A: 10 shots (@5kA) SL1411A: 10 shots (@10kA)	SL1011A: 5 A SL1411A: 10 A	SL1011A: 20 A SL1411A: 65 A	50 V	SL1411A: 12 kA	1 kA						
SL1011A090 SL1411A090	72	90	108	500	600																
SL1011A145	116	145	174	500	650																
SL1011A150 SL1411A150 ⁵	120	150	180	500	650																
SL1011A230 SL1411A230	184	230	276	550	700																
SL1011A250 SL1411A250	200	250	300	600	800																
SL1011A260	210	260	310	600	800																
SL1011A350 SL1411A350	280	350	420	800	900																
SL1011A470 SL1411A470	376	470	564	1000	1100																
SL1011A500	400	500	600	1100	1200																
SL1011A600 SL1411A600 ⁵	480	600	720	1200	1400																
						10 ¹⁰ Ω (at 100V)													135 V		

Notes:

- At delivery AQL 0.65 level II, DIN ISO 2859
- In ionized mode
- Comparable to the silicon measurement Switching Voltage (Vs)
- Tested according to ITU-T Rec. K.12 < 150 msec.
- Not UL Recognized

Product Characteristics

Materials	Leaded Device: Nickel-plated with Tin-plated wires Core and Surface Mount: Dull Tin-plated
Product Marking	Littelfuse 'LF' Mark, voltage and date code

Glow to Arc Transition Current	< 0.5 Amps
Glow Voltage	~60 Volts
Storage and Operational Temperature	-40 to +90°C

Device Dimensions

For SL1011A Series:

'A' Type Axial Lead Devices



'C' Type Core Devices

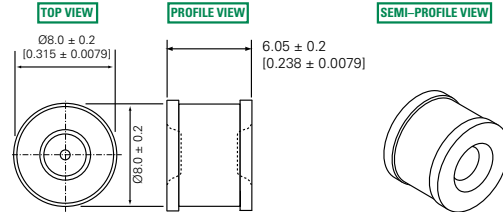

For SL1411A series:

'A' Type Axial Lead Devices

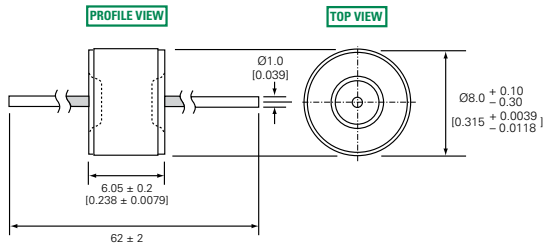

'SM' Type Surface Mount Devices

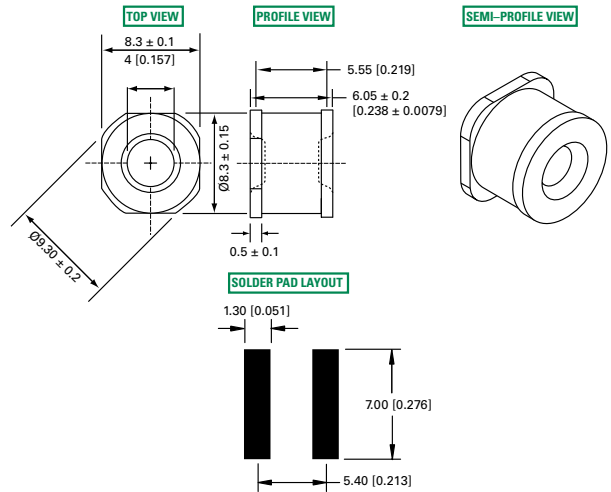

'C' Type Core Devices

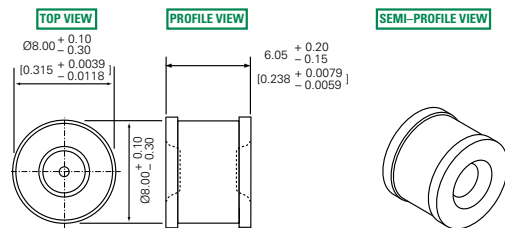

Soldering Parameters - Reflow Soldering (Surface Mount Devices)

Reflow Condition		Pb-free assembly
Pre Heat	- Temperature Min ($T_{s(min)}$)	150°C
	- Temperature Max ($T_{s(max)}$)	200°C
	- Time (Min to Max) (t_s)	60 – 180 seconds
Average Ramp-up Rate (Liquidus Temp (T_L) to peak)		3°C/second max.
$T_{s(max)}$ to T_L - Ramp-up Rate		5°C/second max.
Reflow	- Temperature (T_L) (Liquidus)	217°C
	- Temperature (t_L)	60 – 150 seconds
Peak Temperature (T_p)		260 ^{+0/-5} °C
Time within 5°C of Actual Peak Temperature (t_p)		10 – 30 seconds
Ramp-down Rate		6°C/second max.
Time 25°C to Peak Temperature (T_p)		8 minutes max.
Do not exceed		260°C

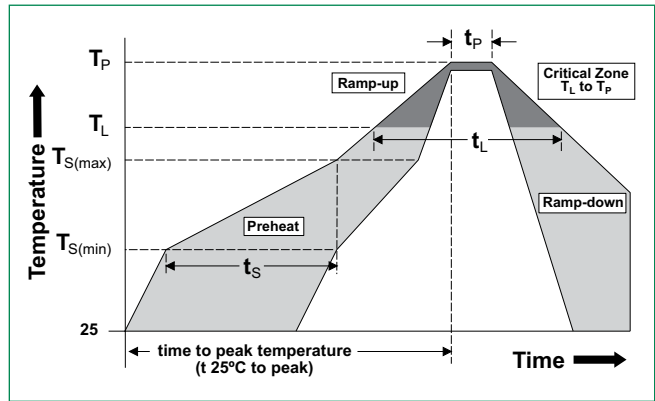

Soldering Parameters - Wave Soldering (Thru-Hole Devices)

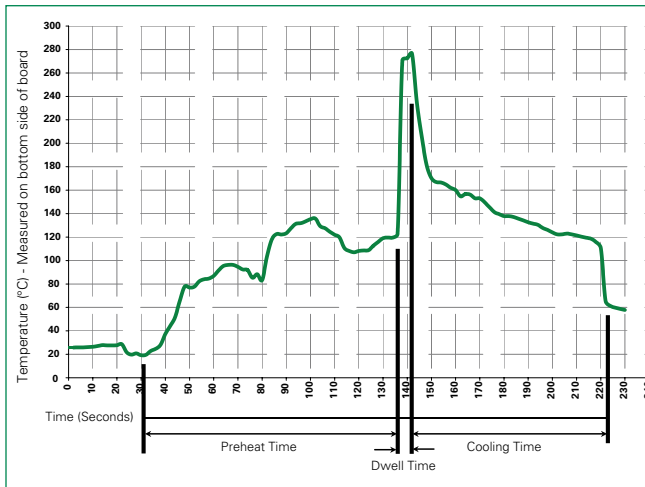

Recommended Process Parameters:

Wave Parameter	Lead-Free Recommendation
Preheat: (Depends on Flux Activation Temperature)	(Typical Industry Recommendation)
Temperature Minimum:	100° C
Temperature Maximum:	150° C
Preheat Time:	60-180 seconds
Solder Pot Temperature:	280° C Maximum
Solder Dwell Time:	2-5 seconds

Soldering Parameters - Hand Soldering

Solder Iron Temperature: 350° C +/- 5°C
Heating Time: 5 seconds max.

Packaging Dimensions

For Axial Lead Items

Dimensions are in millimeters [and inches]



Dimensions are in millimeters [and inches]

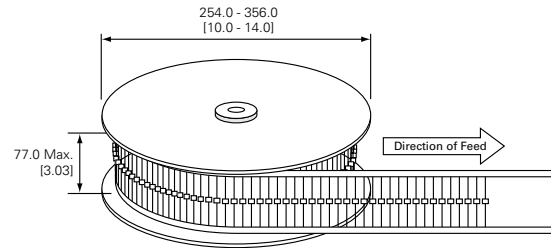

For 'SM' Type Surface Mount Items (SL1411A series only)

Dimensions are in millimeters [and inches]



Dimensions are in millimeters [and inches]

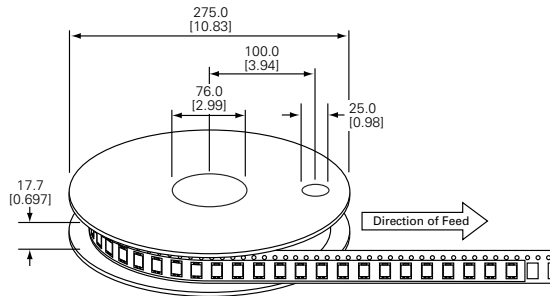

For 'C' Type Core Items: Packed in plastic bag (500 pcs)

Part Numbering System and Ordering Information

For SL1011A series:

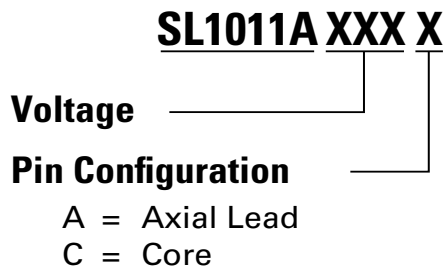

SL1411 A XXX XX

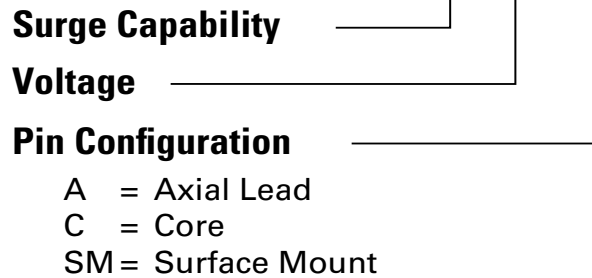

Remarks: Formed leads are available on request

Looking for pricing, stock, or lifecycle information?

Click below to explore more details on WIN SOURCE:

 [View SL1411A600C on WIN SOURCE](#)

 [Littelfuse Inc. Information](#)

Optimize Your Supply Chain with WIN SOURCE Solutions

-  Global Sourcing Solution
-  Obsolete Management
-  Cost Control Management
-  Shortage Management
-  Alternative Solution
-  Excess Inventory Management