



**THE DATASHEET OF
SL1122A090**



SL1122A Series Hybrid



Description

The SL1122A series Hybrid features a high performance Alpha Gas Plasma Tube in conjunction with a MOV. These devices are matched so that high speed pulses are initially clamped by the MOV, then as the current rises, the transient energy is switched through the gas tube. The Hybrid offers high levels of performance on fast rising transients in the domain of 100V/μs to 10 kV/μs, so eliminates the dv/dt switching delay normally exhibited by standard GDTs. These devices are extremely robust and are able to divert a 10,000 Amp pulse without destruction.

Agency Approvals

AGENCY	AGENCY FILE NUMBER
	E128662

2 Electrode GDT Graphical Symbol

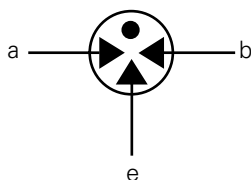

a = TIP
b = RING
e = GROUND
(centre electrode)

Features

- RoHs Compliant
- Excellent response to fast rising transients
- Flat response up to 10kV/μs
- 10kA surge capability tested with 8/20μs pulse as defined by IEC 61000-4-5
- Thermal failsafe

Applications

- MDF protection
- ADSL equipment
- XDSL equipment
- Alarm panels
- General telecom equipment

Electrical Characteristics

Part Number	Device Specifications (at 25°C)						Life Ratings				
	DC Breakdown in Volts ^{1,2} (@100V/s)			DC Voltage ² (1kV/μs Ignition Time)	Insulation Resistance	Capacitance (@1MHz, 0V bias, 1V oscillation)	Arc Voltage (on state voltage) @1Amp Min	Surge Life ¹ (10/1000μs 300x +/-)	Surge Current ¹ (8/20μs x 10)	Nominal AC Discharge Current ¹ (10x1s@50Hz)	DC Holdover Voltage (<150msecs.)
	MIN	TYP	MAX		MIN	MAX	TYP				TYP
SL1122A090	72	90	108	200 (< 10μs)	> 10 ⁸ Ω (at 50V)	270 pF	~10 to 35 Volts	200 A	10 kA	10 A	50 V
SL1122A230	184	230	276	350 (< 10μs)	> 10 ⁸ Ω (at 100V)	100 pF					135 V
SL1122A260	210	260	310	400 (< 10μs)							

Tested in accordance with ITU-T Rec K.12

Notes:

1. Total current through centre electrode
2. Maximum Peak Break Over Voltage

Product Characteristics

Materials	Electrode Base: Copper Electrode Plating: Bright Tin Body: Ceramic
Product Marking	Littelfuse 'LF' Mark, voltage and date code. Red.

Glow to Arc Transition Current	~1 Amp
Glow Voltage	~60 to 200 Volts
Storage and Operational Temperature	-40 to +90°C
Transverse Voltage (Delay Time)	< 0.2 μSec. (Tested to ITU-T Rec.K.12)

Device Dimensions

Radial Lead Devices

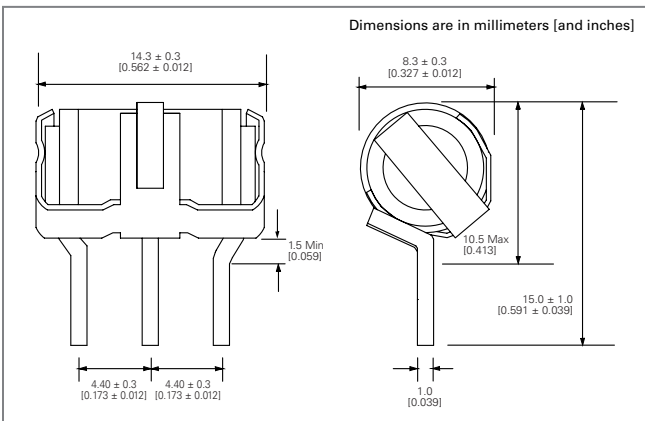

Packaging Dimensions

For Radial Lead Items: Packed in tray (100 pcs)

Part Numbering System and Ordering Information

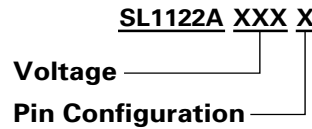

Soldering Parameters - Reflow Soldering

Reflow Condition		Pb-free assembly
Pre Heat	- Temperature Min ($T_{s(min)}$)	150°C
	- Temperature Max ($T_{s(max)}$)	200°C
	- Time (Min to Max) (t_s)	60 – 180 seconds
Average Ramp-up Rate (Liquidus Temp (T_L) to peak)		3°C/second max.
$T_{s(max)}$ to T_L - Ramp-up Rate		5°C/second max.
Reflow	- Temperature (T_L) (Liquidus)	217°C
	- Temperature (t_L)	60 – 150 seconds
Peak Temperature (T_p)		260 ^{+0/-5} °C
Time within 5°C of Actual Peak Temperature (t_p)		10 – 30 seconds
Ramp-down Rate		6°C/second max.
Time 25°C to Peak Temperature (T_p)		8 minutes max.
Do not exceed		260°C

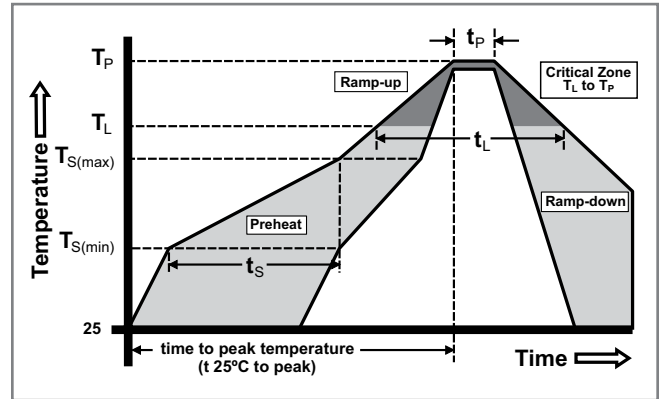

* Devices that are soldered require inspection before use.

Soldering Parameters - Wave Soldering (Thru-Hole Devices)

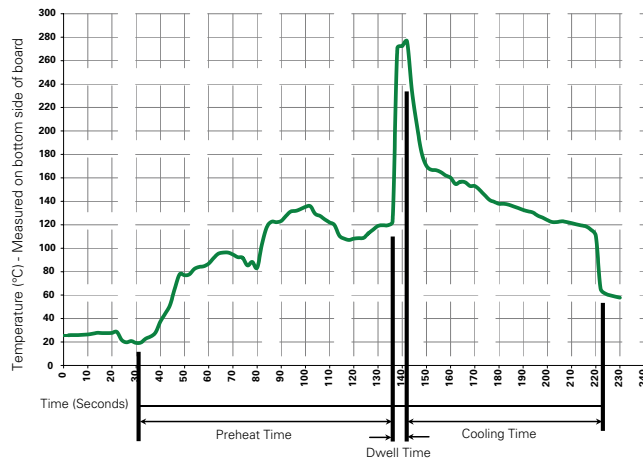

Recommended Process Parameters:

Wave Parameter	Lead-Free Recommendation
Preheat: (Depends on Flux Activation Temperature) (Typical Industry Recommendation)	
Temperature Minimum:	100° C
Temperature Maximum:	150° C
Preheat Time:	60-180 seconds
Solder Pot Temperature:	280° C Maximum
Solder Dwell Time:	2-5 seconds

Soldering Parameters - Hand Soldering

Solder Iron Temperature: 350° C +/- 5°C
 Heating Time: 5 seconds max.

Looking for pricing, stock, or lifecycle information?

Click below to explore more details on WIN SOURCE:

 [View SL1122A090 on WIN SOURCE](#)

 [Littelfuse Inc. Information](#)

Optimize Your Supply Chain with WIN SOURCE Solutions

-  Global Sourcing Solution
-  Obsolete Management
-  Cost Control Management
-  Shortage Management
-  Alternative Solution
-  Excess Inventory Management