



**THE DATASHEET OF
SL1011A500A**



SL1011A and SL1411A Series



Description

The SL1011A and SL1411A series provides high levels of protection against fast rising transients in the 100V/μs to 1kV/μs range usually caused by lightning disturbances.

The SL1011A and SL1411A series offers low capacitance (< 1.5pf) which provides low insertion loss at high frequencies.

SL1011A offers 5kA protection without destruction whereas the SL1411A offer 10kA surge protection without destruction (maximum single surge of 12kA @ 8/20μs).

Agency Approvals

| Agency | Agency File Number |
|--------|--------------------|
| | E128662 |

Features

- Lead-free and RoHS compliant
- Low insertion loss
- Excellent response to fast rising transients
- Ultra low capacitance
- 5kA (SL1011A) or 10kA (SL1411A) surge capability tested with 8/20μs pulse as defined by IEC 61000-4-5 2nd Edition

2 Electrode GDT Graphical Symbol

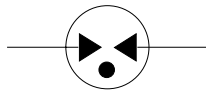

Applications

- Broadband equipment
- ADSL equipment
- XDSL equipment
- Satellite and CATV equipment
- General telecom equipment

Additional Information



**Datasheet
SL1011A**



**Resources
SL1011A**



**Samples
SL1011A**



**Datasheet
SL1411A**



**Resources
SL1411A**



**Samples
SL1411A**

Electrical Characteristics

| Part Number | Device Specifications (at 25°C) | | | | | | Life Ratings | | | | | | | | |
|---|--|-----|-----|--|--------------------------------------|------------------------------|---------------------|---|------------------------------|---|---|--|----------------------------------|---|------------|
| | DC Breakdown in Volts ^{1,2} (@100V/s) | | | Impulse Breakdown in Volts ³ (@100V/μs) | Impulse Breakdown In Volts (@1kV/μs) | Insulation Resistance | Capacitance (@1MHz) | Arc Voltage (on state Voltage) @ 1Amp Min | Surge Life (@100A 10/1000μs) | Nominal Impulse Discharge Current (8/20μs) | Nominal AC Discharge Current (10x1s @50-60Hz) | AC Discharge Current (9 Cycles @ 50Hz) | DC Holdover Voltage ⁴ | Max Impulse Discharge Current (1 Application) | |
| | MIN | TYP | MAX | MAX | | MIN | MAX | TYP | | | | | TYP | @ 8/20μs | @ 10/350μs |
| SL1011A075 SL1411A075 | 60 | 75 | 90 | 500 | 700 | 10 ¹⁰ Ω (at 50V) | 1.5 pF | ~20 V | 300 shots | SL1011A: 10 shots (@5kA) SL1411A: 10 shots (@10kA) | SL1011A: 5 A SL1411A: 10 A | SL1011A: 20 A SL1411A: 65 A | 50 V | SL1411A: 12 kA | 1 kA |
| SL1011A090 SL1411A090 | 72 | 90 | 108 | 500 | 600 | | | | | | | | | | |
| SL1011A145 SL1011A150 SL1411A150 ⁵ | 116 | 145 | 174 | 500 | 650 | 10 ¹⁰ Ω (at 100V) | 1.5 pF | ~20 V | 300 shots | SL1011A: 10 shots (@5kA) SL1411A: 10 shots (@10kA) | SL1011A: 5 A SL1411A: 10 A | SL1011A: 20 A SL1411A: 65 A | 135 V | SL1411A: 12 kA | 1 kA |
| SL1011A230 SL1411A230 | 184 | 230 | 276 | 550 | 700 | | | | | | | | | | |
| SL1011A250 SL1411A250 | 200 | 250 | 300 | 600 | 800 | 10 ¹⁰ Ω (at 100V) | 1.5 pF | ~20 V | 300 shots | SL1011A: 10 shots (@5kA) SL1411A: 10 shots (@10kA) | SL1011A: 5 A SL1411A: 10 A | SL1011A: 20 A SL1411A: 65 A | 135 V | SL1411A: 12 kA | 1 kA |
| SL1011A260 SL1011A350 SL1411A350 | 210 | 260 | 310 | 600 | 800 | | | | | | | | | | |
| SL1011A470 SL1411A470 | 376 | 470 | 564 | 1000 | 1100 | 10 ¹⁰ Ω (at 100V) | 1.5 pF | ~20 V | 300 shots | SL1011A: 10 shots (@5kA) SL1411A: 10 shots (@10kA) | SL1011A: 5 A SL1411A: 10 A | SL1011A: 20 A SL1411A: 65 A | 135 V | SL1411A: 12 kA | 1 kA |
| SL1011A500 SL1011A600 SL1411A600 ⁵ | 400 | 500 | 600 | 1100 | 1200 | | | | | | | | | | |
| SL1011A600 SL1411A600 ⁵ | 480 | 600 | 720 | 1200 | 1400 | | | | | | | | | | |

Notes:

- At delivery AQL 0.65 level II, DIN ISO 2859
- In ionized mode
- Comparable to the silicon measurement Switching Voltage (Vs)
- Tested according to ITU-T Rec. K.12 < 150 msec.
- Not UL Recognized

Product Characteristics

| | |
|------------------------|---|
| Materials | Leaded Device: Nickel-plated with Tin-plated wires Core and Surface Mount: Dull Tin-plated |
| Product Marking | Littelfuse 'LF' Mark, voltage and date code |

| | |
|--|--------------|
| Glow to Arc Transition Current | < 0.5 Amps |
| Glow Voltage | ~60 Volts |
| Storage and Operational Temperature | -40 to +90°C |

Device Dimensions

For SL1011A Series:

'A' Type Axial Lead Devices



'C' Type Core Devices

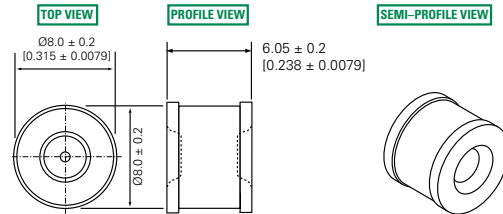

For SL1411A series:

'A' Type Axial Lead Devices

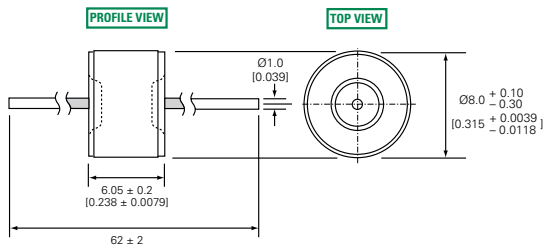

'SM' Type Surface Mount Devices

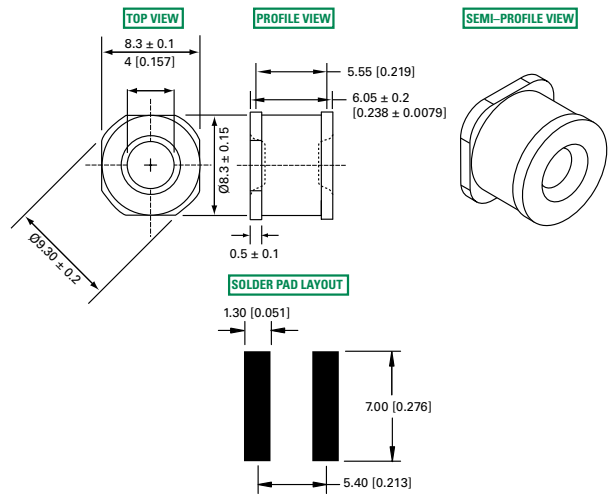

'C' Type Core Devices

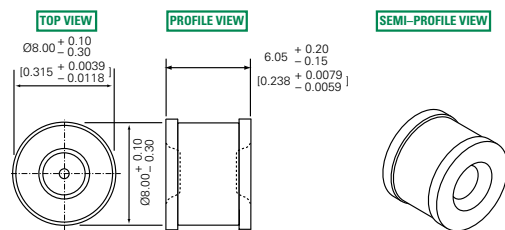

Soldering Parameters - Reflow Soldering (Surface Mount Devices)

| | | |
|--|------------------------------------|-------------------------|
| Reflow Condition | | Pb-free assembly |
| Pre Heat | - Temperature Min ($T_{s(min)}$) | 150°C |
| | - Temperature Max ($T_{s(max)}$) | 200°C |
| | - Time (Min to Max) (t_s) | 60 – 180 seconds |
| Average Ramp-up Rate (Liquidus Temp (T_L) to peak) | | 3°C/second max. |
| $T_{s(max)}$ to T_L - Ramp-up Rate | | 5°C/second max. |
| Reflow | - Temperature (T_L) (Liquidus) | 217°C |
| | - Temperature (t_L) | 60 – 150 seconds |
| Peak Temperature (T_p) | | 260 ^{+0/-5} °C |
| Time within 5°C of Actual Peak Temperature (t_p) | | 10 – 30 seconds |
| Ramp-down Rate | | 6°C/second max. |
| Time 25°C to Peak Temperature (T_p) | | 8 minutes max. |
| Do not exceed | | 260°C |

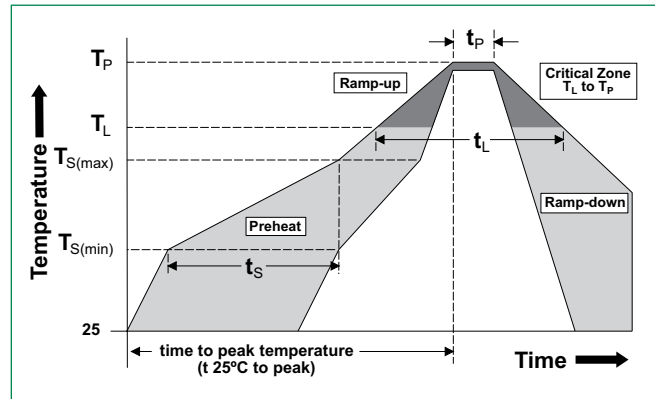

Soldering Parameters - Wave Soldering (Thru-Hole Devices)

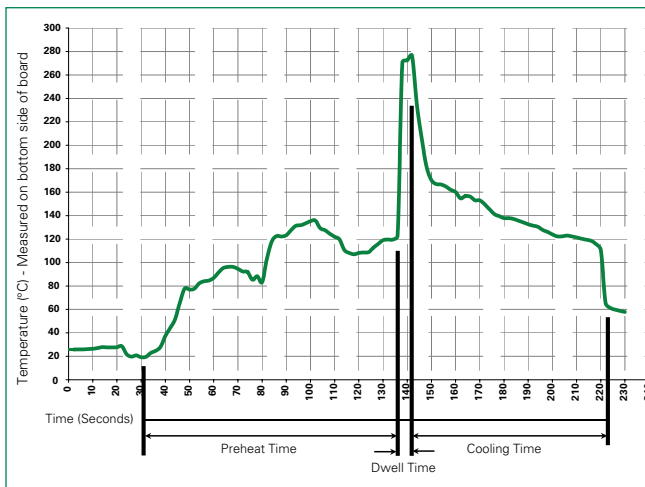

Recommended Process Parameters:

| Wave Parameter | Lead-Free Recommendation |
|---|-----------------------------------|
| Preheat: (Depends on Flux Activation Temperature) | (Typical Industry Recommendation) |
| Temperature Minimum: | 100° C |
| Temperature Maximum: | 150° C |
| Preheat Time: | 60-180 seconds |
| Solder Pot Temperature: | 280° C Maximum |
| Solder Dwell Time: | 2-5 seconds |

Soldering Parameters - Hand Soldering

Solder Iron Temperature: 350° C +/- 5°C
 Heating Time: 5 seconds max.

Packaging Dimensions

For Axial Lead Items

Dimensions are in millimeters [and inches]



Dimensions are in millimeters [and inches]

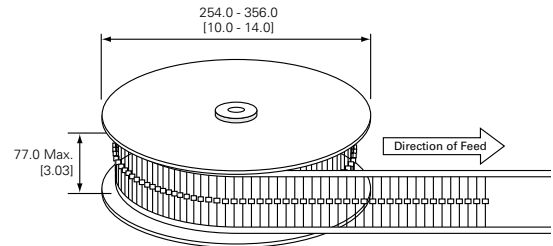

For 'SM' Type Surface Mount Items (SL1411A series only)

Dimensions are in millimeters [and inches]



Dimensions are in millimeters [and inches]

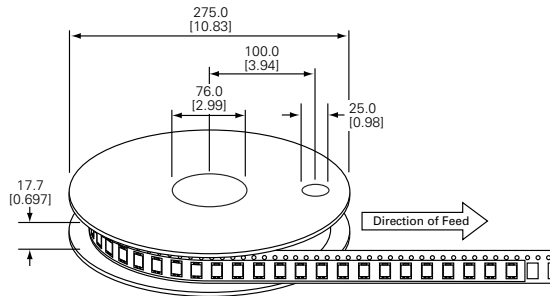

For 'C' Type Core Items: Packed in plastic bag (500 pcs)

Part Numbering System and Ordering Information

For SL1011A series:

SL1011A XXX X

Voltage

Pin Configuration

- A = Axial Lead
- C = Core

Remarks: Formed leads are available on request

SL1411 A XXX XX

Surge Capability



Voltage

Pin Configuration

- A = Axial Lead
- C = Core
- SM = Surface Mount

Looking for pricing, stock, or lifecycle information?

Click below to explore more details on WIN SOURCE:

-  [View SL1011A500A on WIN SOURCE](#)
-  [Littelfuse Inc. Information](#)

Optimize Your Supply Chain with WIN SOURCE Solutions

-  Global Sourcing Solution
-  Obsolete Management
-  Cost Control Management
-  Shortage Management
-  Alternative Solution
-  Excess Inventory Management