

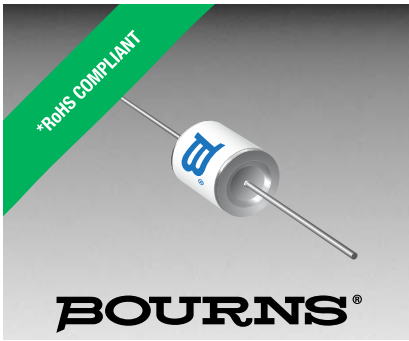

**THE DATASHEET OF  
SA2-6300-DLT-STD**





## Features

- Formerly a JENSEN+DEVICES product
- High insulation resistance
- Quick response, long service life
- Available DC breakdown range: 2.4 kV to 7.2 kV
- Wide operating temperature range
- RoHS compliant\*

## Applications

- Street lighting
- Medical devices (low/medium risk)\*\*
- Air conditioning
- Power supplies
- Projectors
- Welders

# SA2 Series High Voltage Gas Discharge Tube

### Description

Bourns® SA2 Series two-electrode High Voltage Gas Discharge Tube devices are designed for high isolation applications. The series offers high insulation resistance over a wide temperature range and is offered with DC breakdowns from 2.4 kV to 7.2 kV. Other customized voltages between 2 kV and 7.2 kV are available upon request.

### Agency Recognition

Agency	Category	Agency File No.
UL	UL 1449	E313168

### Additional Information

Click these links for more information:



[PRODUCT SELECTOR](#) [TECHNICAL LIBRARY](#) [INVENTORY](#) [SAMPLES](#) [CONTACT](#)

### Electrical Characteristics

Part No.	Device Specifications										Life Ratings		
	DC Breakdown Voltage @ 500 V/s				Impulse Breakdown	Ramp	Insulation Resistance @ 250 Vdc	Arc Voltage @ 5A min.	Capacitance @ 1 MHz	Nominal Impulse Discharge		Nom. DC Breakdown After Life	
	Min.	Typ.	Max.	Tol.						Max.	Typ.		1 Operation
SA2-2400-Dxx-STD	2040	2400	2880	-15 % to +20 %	3800 V	@1 kV/μs	10 G Ohm	20 V	1 pF	10 kA, 8/20 μs	5 kA, 8/20 μs, ±5 operations in each polarity	>2.0 kV	
SA2-2400-Cxx-STD	1920	2400	2880	-20 % to +20 %		>1.9 kV							
SA2-3000-Dxx-STD	2550	3000	3600	-15 % to +20 %	4500 V	@7.5 kV/μs						>2.4 kV	
SA2-3000-Cxx-STD	2400	3000	3600	-20 % to +20 %		>2.3 kV							
SA2-3600-Dxx-STD	3060	3600	4320	-15 % to +20 %	5400 V	@7.5 kV/μs						>3.0 kV	
SA2-3600-Cxx-STD	2880	3600	4320	-20 % to +20 %		>2.8 kV							
SA2-4000-Dxx-STD	3400	4000	4800	-15 % to +20 %	6000 V	@7.5 kV/μs						>3.3 kV	
SA2-4000-Cxx-STD	3200	4000	4800	-20 % to +20 %		>3.1 kV							
SA2-5500-Dxx-STD	4675	5500	6600	-15 % to +20 %	8000 V	@7.5 kV/μs						>4.4 kV	
SA2-5500-Cxx-STD	4400	5500	6600	-20 % to +20 %		>4.2 kV							
SA2-5900-Dxx-STD	5015	5900	7080	-15 % to +20 %	8000 V	@7.5 kV/μs						>4.9 kV	
SA2-5900-Cxx-STD	4720	5900	7080	-20 % to +20 %		>4.6 kV							
SA2-6000-Dxx-STD	5100	6000	7200	-15 % to +20 %	8000 V	@7.5 kV/μs						>5.0 kV	
SA2-6000-Cxx-STD	4800	6000	7200	-20 % to +20 %		>4.7 kV							
SA2-6200-Dxx-STD	5270	6200	7440	-15 % to +20 %	8000 V	@7.5 kV/μs						>5.2 kV	
SA2-6200-Cxx-STD	4960	6200	7440	-20 % to +20 %		>4.9 kV							
SA2-6300-Dxx-STD	5355	6300	7560	-15 % to +20 %	9200 V	@7.5 kV/μs						>5.3 kV	
SA2-6300-Cxx-STD	5040	6300	7560	-20 % to +20 %		>5.0 kV							
SA2-7200-Dxx-STD	6120	7200	8640	-15 % to +20 %	10000 V	@1 kV/μs						>6.3 kV	
SA2-7200-Cxx-STD	5760	7200	8640	-20 % to +20 %		>6.0 kV							

Note: Model SA2-7200 specification is based on the customer providing sufficient encapsulation/working environment for the component to avoid outside surface breakdown (e.g., non-contaminated equivalent surface in RH 40 % reaches breakdown at 10-12 kV).

\* RoHS Directive 2015/863, Mar 31, 2015 and Annex.

\*\* Bourns® products have not been designed for and are not intended for use in "lifesaving," "life-critical" or "life-sustaining" applications nor any other applications where failure or malfunction of the Bourns® product may result in personal injury or death. See Legal Disclaimer Notice <http://www.bourns.com/docs/legal/disclaimer.pdf>.

Specifications are subject to change without notice.

Users should verify actual device performance in their specific applications.

The products described herein and this document are subject to specific legal disclaimers as set forth on the last page of this document, and at [www.bourns.com/docs/legal/disclaimer.pdf](http://www.bourns.com/docs/legal/disclaimer.pdf).

# SA2 Series High Voltage Gas Discharge Tube



## Product Characteristics

Operating Temperature Range .....	-40 °C to +125 °C
Storage Temperature Range .....	-65 °C to +125 °C
Device Plating.....	Matte-Sn
Moisture Sensitivity Level.....	1
ESD Classification (HBM).....	6

## Environmental Characteristics

Section	Category	Test	Condition
IEC 60068-2-13 test M	Operational	Low Air Pressure	Temp. +55 °C, Time 0.5 Sec., Pressure 600 hPa
IEC 60068-2-1, test Ab	Non-Operational	Cold	-40 °C, 96 Hours
IEC 60068-2-2, test Bb		Dry Heat	+100 °C, 96 Hours
IEC 60068-2-30, test Ca		Damp Heat, Steady State	+40 °C, 93 % RH, 21 Days
IEC 60068-2-14, test Na		Rapid Change in Temperature	Upper Temp. +100 °C, Lower Temp. -40 °C, 5 Cycles
IEC 60068-2-6, test Fc		Vibration	10-55 Hz, 30 Min. per Axis, Double Amplitude 0.70 Min.
IEC 60068-2-27, test Ea		Shock Test	30 g, 11 ms, Half Sine Pulse
IEC 60068-2-20, test Ta		Solderability	Method 1, +235 °C, 2 Sec., Aging
IEC 60068-2-20, test Tb		Resistance to Soldering Heat	Method 1A, +260 °C, 5 Sec.
IEC 60068-2-21		Robustness of Terminations	Ua1 (Tensile), Ua2 (Thrust), Ub (Bending) and Uc (Torsion)

## How to Order

SA 2 - nnnn - x x x - STD

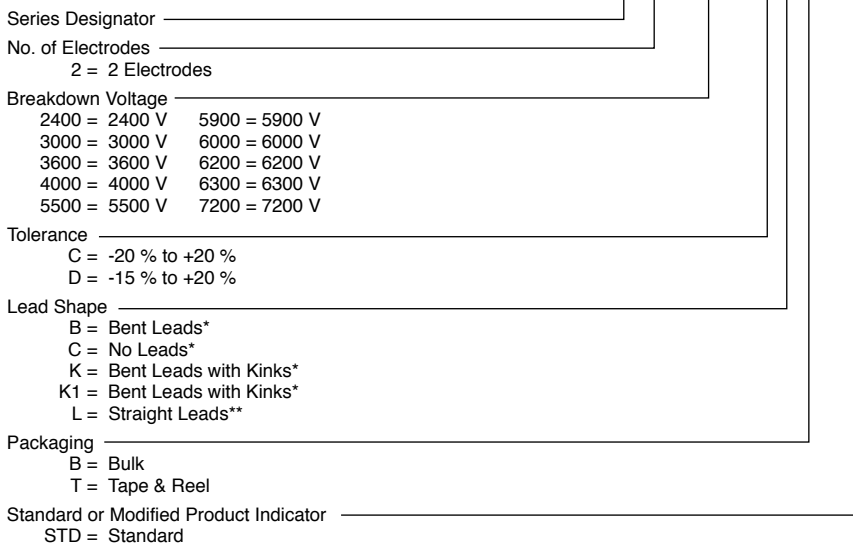

## Typical Part Marking

..... SA2-xxxx

\* Available in bulk packaging only.

\*\* Bulk packaging available for straight lead devices ≤3600 V. Devices >3600 V available in tape and reel only.

Specifications are subject to change without notice.

Users should verify actual device performance in their specific applications.

The products described herein and this document are subject to specific legal disclaimers as set forth on the last page of this document, and at [www.bourns.com/docs/legal/disclaimer.pdf](http://www.bourns.com/docs/legal/disclaimer.pdf).

# SA2 Series High Voltage Gas Discharge Tube

**BOURNS®**

## Product Dimensions

**SA2-xxxx-xLx**

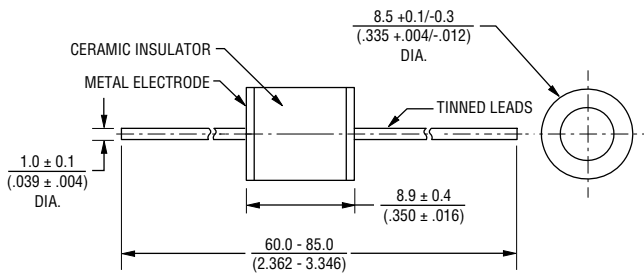

**SA2-xxxx-xKx**



**SA2-xxxx-xCx**

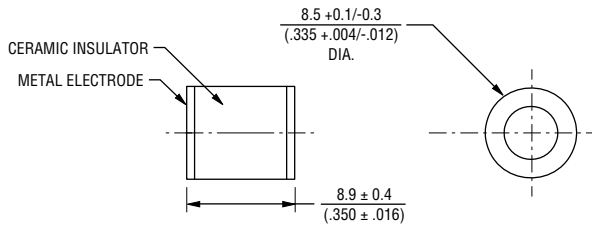

**SA2-xxxx-xK1x**



**SA2-xxxx-xBx**

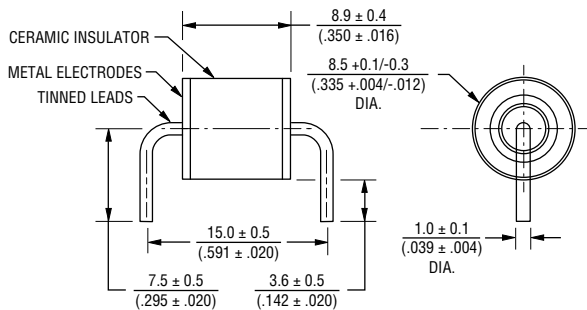

DIMENSIONS:  $\frac{\text{MM}}{\text{(INCHES)}}$

Specifications are subject to change without notice.

Users should verify actual device performance in their specific applications.

The products described herein and this document are subject to specific legal disclaimers as set forth on the last page of this document, and at [www.bourns.com/docs/legal/disclaimer.pdf](http://www.bourns.com/docs/legal/disclaimer.pdf).

# SA2 Series High Voltage Gas Discharge Tube

**BOURNS®**

## Packaging Specifications

Model SA2-xxxx-xxB ships standard bulk pack, 1,000 pcs./bag\*.  
The optional tape and reel packaging contains 1,000 pcs./reel for Model SA2-xxxx-xLT.

\* Straight leads versions >3600 V available in bulk or tape and reel packaging; all other models available in bulk packaging only.

### SA2-xxxx-xLT

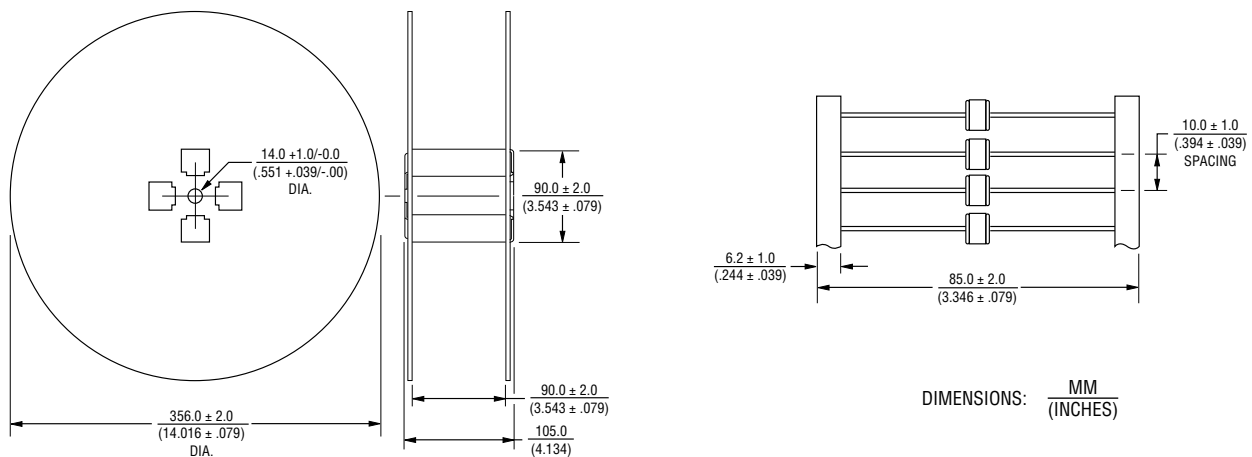

**BOURNS®**

Asia-Pacific: Tel: +886-2 2562-4117 • Email: asiacus@bourns.com

EMEA: Tel: +36 88 885 877 • Email: eurocus@bourns.com

The Americas: Tel: +1-951 781-5500 • Email: americus@bourns.com

[www.bourns.com](http://www.bourns.com)

REV. C 05/21

Specifications are subject to change without notice.

Users should verify actual device performance in their specific applications.

The products described herein and this document are subject to specific legal disclaimers as set forth on the last page of this document, and at [www.bourns.com/docs/legal/disclaimer.pdf](http://www.bourns.com/docs/legal/disclaimer.pdf).

This legal disclaimer applies to purchasers and users of Bourns® products manufactured by or on behalf of Bourns, Inc. and its affiliates (collectively, “Bourns”).

Unless otherwise expressly indicated in writing, Bourns® products and data sheets relating thereto are subject to change without notice. Users should check for and obtain the latest relevant information and verify that such information is current and complete before placing orders for Bourns® products.

The characteristics and parameters of a Bourns® product set forth in its data sheet are based on laboratory conditions, and statements regarding the suitability of products for certain types of applications are based on Bourns’ knowledge of typical requirements in generic applications. The characteristics and parameters of a Bourns® product in a user application may vary from the data sheet characteristics and parameters due to (i) the combination of the Bourns® product with other components in the user’s application, or (ii) the environment of the user application itself. The characteristics and parameters of a Bourns® product also can and do vary in different applications and actual performance may vary over time. Users should always verify the actual performance of the Bourns® product in their specific devices and applications, and make their own independent judgments regarding the amount of additional test margin to design into their device or application to compensate for differences between laboratory and real world conditions.

Unless Bourns has explicitly designated an individual Bourns® product as meeting the requirements of a particular industry standard (e.g., ISO/TS 16949) or a particular qualification (e.g., UL listed or recognized), Bourns is not responsible for any failure of an individual Bourns® product to meet the requirements of such industry standard or particular qualification. Users of Bourns® products are responsible for ensuring compliance with safety-related requirements and standards applicable to their devices or applications.

Bourns® products are not recommended, authorized or intended for use in nuclear, lifesaving, life-critical or life-sustaining applications, nor in any other applications where failure or malfunction may result in personal injury, death, or severe property or environmental damage. Unless expressly and specifically approved in writing by two authorized Bourns representatives on a case-by-case basis, use of any Bourns® products in such unauthorized applications might not be safe and thus is at the user’s sole risk. Life-critical applications include devices identified by the U.S. Food and Drug Administration as Class III devices and generally equivalent classifications outside of the United States.

Bourns expressly identifies those Bourns® standard products that are suitable for use in automotive applications on such products’ data sheets in the section entitled “Applications.” Unless expressly and specifically approved in writing by two authorized Bourns representatives on a case-by-case basis, use of any other Bourns® standard products in an automotive application might not be safe and thus is not recommended, authorized or intended and is at the user’s sole risk. If Bourns expressly identifies a sub-category of automotive application in the data sheet for its standard products (such as infotainment or lighting), such identification means that Bourns has reviewed its standard product and has determined that if such Bourns® standard product is considered for potential use in automotive applications, it should only be used in such sub-category of automotive applications. Any reference to Bourns® standard product in the data sheet as compliant with the AEC-Q standard or “automotive grade” does not by itself mean that Bourns has approved such product for use in an automotive application.

Bourns® standard products are not tested to comply with United States Federal Aviation Administration standards generally or any other generally equivalent governmental organization standard applicable to products designed or manufactured for use in aircraft or space applications. Bourns expressly identifies Bourns® standard products that are suitable for use in aircraft or space applications on such products’ data sheets in the section entitled “Applications.” Unless expressly and specifically approved in writing by two authorized Bourns representatives on a case-by-case basis, use of any other Bourns® standard product in an aircraft or space application might not be safe and thus is not recommended, authorized or intended and is at the user’s sole risk.

The use and level of testing applicable to Bourns® custom products shall be negotiated on a case-by-case basis by Bourns and the user for which such Bourns® custom products are specially designed. Absent a written agreement between Bourns and the user regarding the use and level of such testing, the above provisions applicable to Bourns® standard products shall also apply to such Bourns® custom products.

Users shall not sell, transfer, export or re-export any Bourns® products or technology for use in activities which involve the design, development, production, use or stockpiling of nuclear, chemical or biological weapons or missiles, nor shall they use Bourns® products or technology in any facility which engages in activities relating to such devices. The foregoing restrictions apply to all uses and applications that violate national or international prohibitions, including embargos or international regulations. Further, Bourns® products and Bourns technology and technical data may not under any circumstance be exported or re-exported to countries subject to international sanctions or embargoes. Bourns® products may not, without prior authorization from Bourns and/or the U.S. Government, be resold, transferred, or re-exported to any party not eligible to receive U.S. commodities, software, and technical data.

To the maximum extent permitted by applicable law, Bourns disclaims (i) any and all liability for special, punitive, consequential, incidental or indirect damages or lost revenues or lost profits, and (ii) any and all implied warranties, including implied warranties of fitness for particular purpose, non-infringement and merchantability.



*For your convenience, copies of this Legal Disclaimer Notice with German, Spanish, Japanese, Traditional Chinese and Simplified Chinese bilingual versions are available at:*

*Web Page:* <http://www.bourns.com/legal/disclaimers-terms-and-policies>

*PDF:* <http://www.bourns.com/docs/Legal/disclaimer.pdf>

## Looking for pricing, stock, or lifecycle information?

Click below to explore more details on WIN SOURCE:

-  [View SA2-6300-DLT-STD on WIN SOURCE](#)
-  [Bourns Inc. Information](#)

## Optimize Your Supply Chain with WIN SOURCE Solutions

-  Global Sourcing Solution
-  Obsolete Management
-  Cost Control Management
-  Shortage Management
-  Alternative Solution
-  Excess Inventory Management