



**THE DATASHEET OF  
SCD475K601A3Z25-F**



# Type SCD IGBT Snubber Capacitor Modules

## High dV/dt Direct Mount IGBT Snubber



Style SCD offers protection against voltage transients in low to medium current IGBT applications where high dV/dt is encountered. Connect these capacitors from C1 to E2 on a dual IGBT module or from P to N on a six-pack module to eliminate severe voltage transients. Parts ending with Z25 fit IGBTs with 23mm, 25mm and 28mm lead spacing. If you have a preferred lead spacing, please specify.

### Highlights

- High peak & RMS current capability
- Mount directly to the IGBT module
- Low inductance
- Low loss polypropylene dielectric
- Self healing
- Other terminal spacing and capacitance values available.
- We can build to your specs!
- 85 °C ambient temperature

### Specifications

Capacitance Range	0.22 to 4.7 $\mu$ F
Capacitance Tolerance	$\pm$ 10% (K) standard, $\pm$ 5% (J) optional
Rated Voltage	600 to 2000 Vdc
Operating Temperature Range	-55 °C to 85 °C
Maximum rms Current	Check tables for values
Test Voltage between Terminals @ 25°C	160% rated DC voltage for 60 s
Test Voltage between Terminals & Case @ 25°C	3 kVac @ 50/60 Hz for 60 s
Life Test	2000 h @ 85 °C, 125% rated DC voltage
Life Expectancy	60,000 h @ rated Vdc, 70 °C 30,000 h @ rated Vac, 70 °C
<a href="#">Regulatory Information</a>	

### Dimensions



Construction Details	
Case Material	Plastic UL94V-0
Resin Material	Dry Resin UL94V-0
Terminal Material	Tin Plated Copper

Tolerances:  $\pm$ 0.5mm unless otherwise specified

# Type SCD IGBT Snubber Capacitor Modules

High dV/dt Direct Mount IGBT Snubber

## Mounting Across the Bus?

CDE Will Accommodate Your Bus Structure

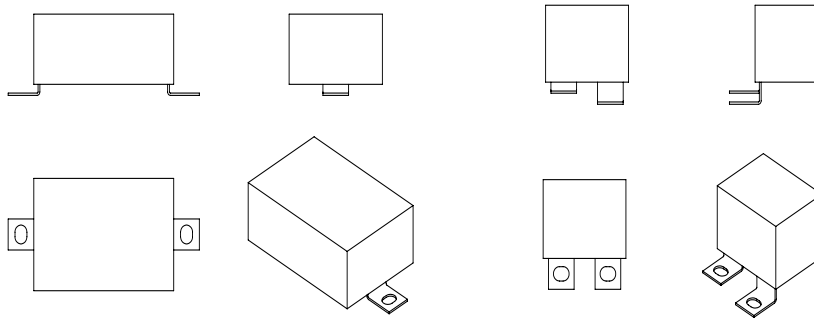

## Dual Snubber Assembly Option



## Part Numbering System

SCD	105	K	122	A	3	-	25	-F
Series Type Designation	Capacitance in pF	Tolerance Code	Voltage	Internal Assembly Code	Type of Section to be used	Lug Configuration	Lug Spacing	RoHS Compliant Indicator
	104 = 0.1 $\mu$ F	J = $\pm$ 5%	601 = 600 Vdc			Z = Standard	22 = 22 mm	
	105 = 1 $\mu$ F	K = $\pm$ 10%	122 = 1200 Vdc			25.4 mm C-C	24 = 24 mm	
	225 = 2.2 $\mu$ F		202 = 2000 Vdc				25 = 25 mm	
							28 = 28 mm	
							29 = 29 mm	

# Type SCD IGBT Snubber Capacitor Modules

## High dV/dt Direct Mount IGBT Snubber

### Ratings

**Note:** Other ratings, sizes and performance specification available upon request. Contact us.

Catalog Part Number	Cap. ( $\mu$ F)	Volts		I <sub>rms</sub> 100 kHz						
		Volts (Vdc)	60 Hz (Vac)	dV/dt (V/ $\mu$ s)	I <sub>pk</sub> (A)	ESR (m $\Omega$ )	55 °C (Arms)	W (mm)	L (mm)	H (mm)
<b>600 Vdc</b>										
SCD474K601A3Z25-F	0.47	600	275	250	118	9	9.2	24.6	47.0	24.1
SCD684K601A3Z25-F	0.68	600	275	250	170	7	11.5	29.0	47.0	26.7
SCD105K601A3Z25-F	1.00	600	275	200	200	5	14.0	29.0	47.0	26.7
SCD155K601A3Z25-F	1.50	600	275	150	225	4	17.1	29.0	47.0	26.7
SCD205K601A3Z25-F	2.00	600	275	150	300	3	20.7	32.3	45.1	35.6
SCD335K601A3Z25-F	3.30	600	400	300	825	5	35.0	38.1	52.1	38.1
SCD475K601A3Z25-F	4.70	600	400	250	1175	4	46.2	46.4	56.5	50.2
<b>1000 Vdc</b>										
SCD474K102A3Z25-F	0.47	1000	275	250	118	11	9.2	24.6	47.0	24.1
SCD474K102D3Z25-F	0.47	1000	500	700	329	8	12.1	29.0	47.0	26.7
SCD684K102A3Z25-F	0.68	1000	275	200	136	7	11.5	29.0	47.0	26.7
SCD684K102D3Z25-F	0.68	1000	500	500	340	7	14.4	29.0	47.0	26.7
SCD105K102A3Z25-F	1.00	1000	275	200	200	4	14.0	29.0	47.0	26.7
SCD105K102D3Z25-F	1.00	1000	500	400	400	5	17.5	29.0	47.0	26.7
SCD155K102A3Z25-F	1.50	1000	275	160	240	4	17.9	32.3	45.1	35.6
SCD155K102D3Z25-F	1.50	1000	500	400	600	3	22.4	34.8	45.1	35.6
SCD205K102A3Z25-F	2.00	1000	275	160	320	4	20.9	34.8	45.1	35.6
SCD205K102D3Z25-F	2.00	1000	500	400	800	5	26.2	38.1	52.1	38.1
<b>1200 Vdc</b>										
SCD224K122A3Z25-F	0.22	1200	500	650	143	19	7.9	24.6	47.0	24.1
SCD334K122A3Z25-F	0.33	1200	500	650	215	13	10.0	29.0	47.0	26.7
SCD474K122A3Z25-F	0.47	1200	500	500	235	10	12.0	29.0	47.0	26.7
SCD684K122A3Z25-F	0.68	1200	500	500	340	7	15.1	32.3	45.1	35.6
SCD105K122A3Z25-F	1.00	1200	500	500	500	5	18.5	34.8	45.1	35.6
SCD155K122A3Z25-F	1.50	1200	500	400	600	4	23.9	38.1	52.1	38.1
SCD205K122A3Z25-F	2.00	1200	500	400	800	4	30.1	46.4	56.5	50.2
SCD305K122C3Z25-F	3.00	1200	500	400	1200	5	39.7	76.2	62.9	38.1
<b>1600 Vdc</b>										
SCD224K162A3Z25-F	0.22	1600	500	650	143	19	7.9	24.6	47.0	24.1
SCD334K162A3Z25-F	0.33	1600	500	650	215	12	10.0	29.0	47.0	26.7
SCD474K162A3Z25-F	0.47	1600	500	650	306	10	12.6	32.3	45.1	35.6
SCD684K162A3Z25-F	0.68	1600	500	650	442	7	15.3	34.8	45.1	35.6
SCD105K162A3Z25-F	1.00	1600	500	500	500	6	19.5	38.1	52.1	38.1
SCD155K162A3Z25-F	1.50	1600	500	400	600	5	25.6	41.9	68.6	38.1
SCD205K162A3Z25-F	2.00	1600	500	400	800	5	30.6	44.5	66.7	46.4
<b>2000 Vdc</b>										
SCD224K202A3Z25-F	0.22	2000	500	800	176	19	8.2	24.6	47.0	24.1
SCD334K202A3Z25-F	0.33	2000	500	800	264	13	10.5	32.3	45.1	35.6
SCD474K202A3Z25-F	0.47	2000	500	600	282	10	13.0	34.3	55.9	30.5
SCD684K202A3Z25-F	0.68	2000	500	600	408	8	16.1	38.1	52.1	38.1
SCD105K202A3Z25-F	1.00	2000	500	600	600	6	21.3	46.4	56.5	50.2

Note: Modify Catalog Part Number to specify lead spacing. Example: 44mm spacing would use -44 instead of Z25. Other capacitance values and lead orientations are available. Contact us.

**Notice and Disclaimer:** All product drawings, descriptions, specifications, statements, information and data (collectively, the "Information") in this datasheet or other publication are subject to change. The customer is responsible for checking, confirming and verifying the extent to which the Information contained in this datasheet or other publication is applicable to an order at the time the order is placed. All Information given herein is believed to be accurate and reliable, but it is presented without any guarantee, warranty, representation or responsibility of any kind, expressed or implied. Statements of suitability for certain applications are based on the knowledge that the Cornell Dubilier company providing such statements ("Cornell Dubilier") has of operating conditions that such Cornell Dubilier company regards as typical for such applications, but are not intended to constitute any guarantee, warranty or representation regarding any such matter – and Cornell Dubilier specifically and expressly disclaims any guarantee, warranty or representation concerning the suitability for a specific customer application, use, storage, transportation, or operating environment. The Information is intended for use only by customers who have the requisite experience and capability to determine the correct products for their application. Any technical advice inferred from this Information or otherwise provided by Cornell Dubilier with reference to the use of any Cornell Dubilier products is given gratis (unless otherwise specified by Cornell Dubilier), and Cornell Dubilier assumes no obligation or liability for the advice given or results obtained. Although Cornell Dubilier strives to apply the most stringent quality and safety standards regarding the design and manufacturing of its products, in light of the current state of the art, isolated component failures may still occur. Accordingly, customer applications which require a high degree of reliability or safety should employ suitable designs or other safeguards (such as installation of protective circuitry or redundancies or other appropriate protective measures) in order to ensure that the failure of an electrical component does not result in a risk of personal injury or property damage. Although all product-related warnings, cautions and notes must be observed, the customer should not assume that all safety measures are indicated in such warnings, cautions and notes, or that other safety measures may not be required.

## Looking for pricing, stock, or lifecycle information?

Click below to explore more details on WIN SOURCE:

-  [View SCD475K601A3Z25-F on WIN SOURCE](#)
-  [Cornell Dubilier Electronics \(CDE\) Information](#)

## Optimize Your Supply Chain with WIN SOURCE Solutions

-  Global Sourcing Solution
-  Obsolete Management
-  Cost Control Management
-  Shortage Management
-  Alternative Solution
-  Excess Inventory Management