

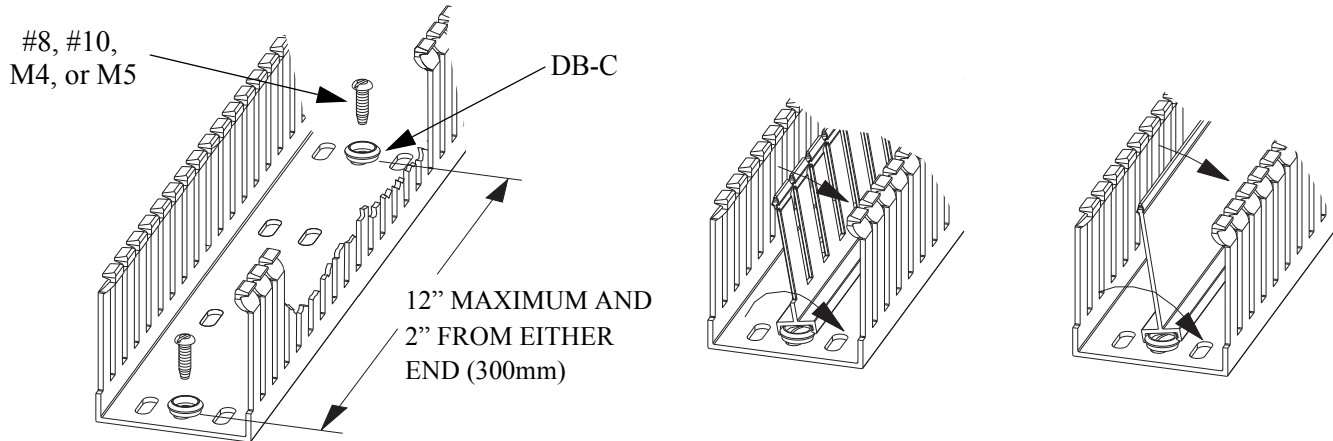

## INSTALLATION OF SOLID/SLOTTED DIVIDER WALL AND MOUNTING



## REMOVING FINGERS ON SLOTTED DIVIDER WALL



## REMOVING SECTIONS FROM SLOTTED DIVIDER WALL WITH DNT-100

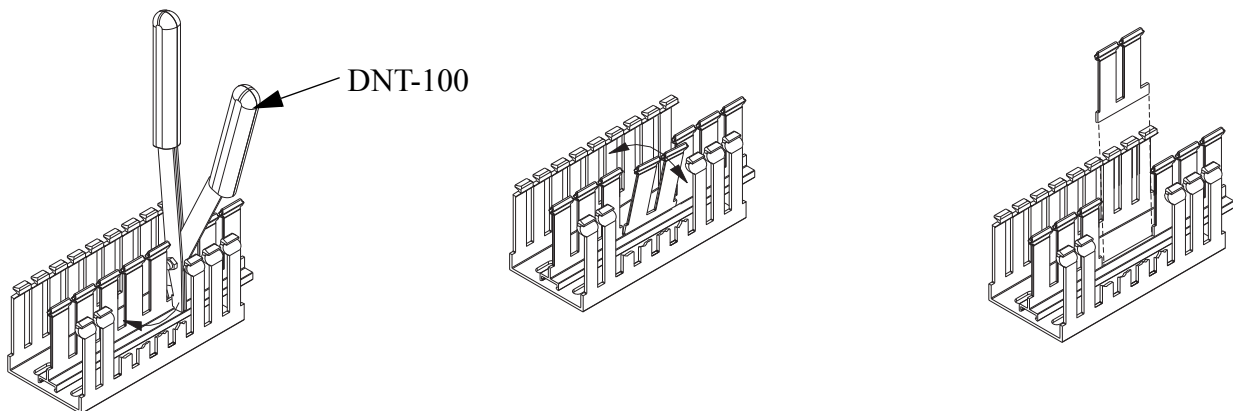

## Looking for pricing, stock, or lifecycle information?

Click below to explore more details on WIN SOURCE:

 [View SD3H6 on WIN SOURCE](#)

 [Panduit Corp](#) Information

## Optimize Your Supply Chain with WIN SOURCE Solutions

-  Global Sourcing Solution
-  Obsolete Management
-  Cost Control Management
-  Shortage Management
-  Alternative Solution
-  Excess Inventory Management