



THE DATASHEET OF
S553-5999-F3-F



10BASE-T LAN MAGNETICS

Dual Isolation Transformer

LM05510

- Transformer turns ratio RX 1CT : 1CT and TX 1CT : 2CT
- Utilizes standard surface mount packaging
- Meets all IEEE 802.3 performance requirements
- Low profile, surface mount packaging rated to 225° C peak IR reflow temperature
- Operating temperature -40° to +85° C
- Minimum interwinding breakdown voltage of 1500 Vrms

ELECTRICAL SPECIFICATIONS AT 25° C

Part Number	OCL μH min		Leakage Inductance μH max		Interwinding Capacitance pf max		DCR Ω max			
	RX	TX	RX	TX	1 - 16	6 -11	TXIN	TXO	RXIN	RXO
S553-5999-F2	110	28	0.3	0.2	10	10	0.75	0.75	0.75	0.75
S553-5999-F3	110	28	0.3	0.2	10	10	0.75	0.75	0.75	0.75

SCHEMATIC

S553-5999-F2

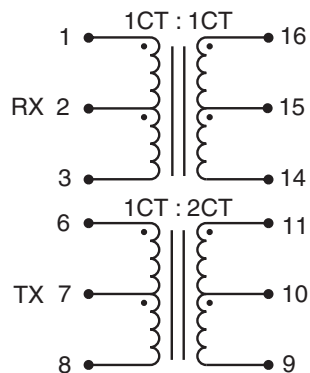

S553-5999-F3

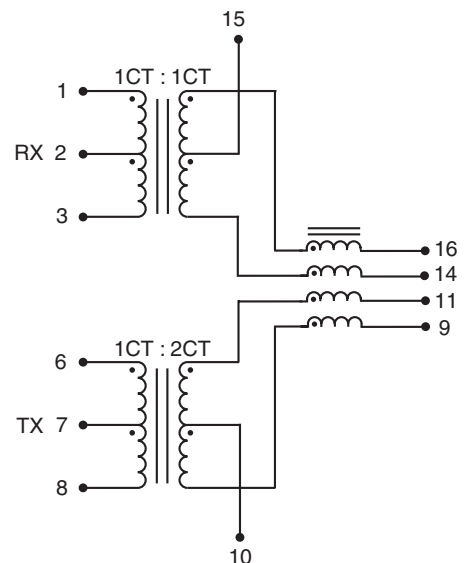

LM05510

MECHANICAL

S553-5999-F2
S553-5999-F3

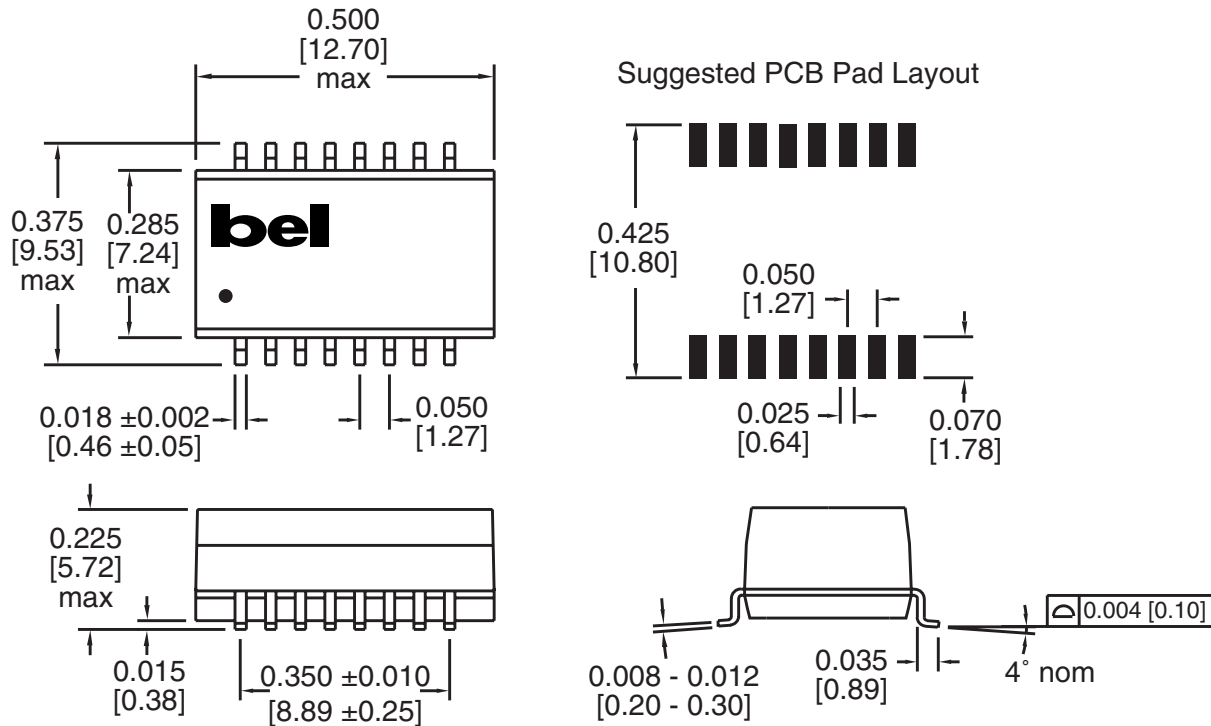

Dimensions are in inches [millimeters].
Standard dimension tolerance is ±0.005 [0.13] unless otherwise noted.

©2005 Bel Fuse Inc. Specifications subject to change without notice. 03.05

CORPORATE

Bel Fuse Inc.
206 Van Vorst Street
Jersey City, NJ 07302
Tel 201-432-0463
Fax 201-432-9542
www.belfuse.com

FAR EAST

Bel Fuse Ltd.
8F / 8 Luk Hop Street
San Po Kong
Kowloon, Hong Kong
Tel 852-2328-5515
Fax 852-2352-3706
www.belfuse.com

EUROPE

Bel Fuse Europe Ltd.
Preston Technology Management Centre
Marsh Lane, Suite G7, Preston
Lancashire, PR1 8UD, U.K.
Tel 44-1772-556601
Fax 44-1772-888366
www.belfuse.com

Looking for pricing, stock, or lifecycle information?

Click below to explore more details on WIN SOURCE:

 [View S553-5999-F3-F on WIN SOURCE](#)

 [Bel Fuse Inc. Information](#)

Optimize Your Supply Chain with WIN SOURCE Solutions

-  Global Sourcing Solution
-  Obsolete Management
-  Cost Control Management
-  Shortage Management
-  Alternative Solution
-  Excess Inventory Management