



**THE DATASHEET OF  
SI7060-B-01-IVR**





# Si7060 Data Sheet

The Si7060 family of I<sup>2</sup>C temperature sensors features high conversion speed (143  $\mu$ sec typical), programmable over or under temperature interrupt, and interrupt polarity with 200 msec (typical) sampling time.

The output works as a comparator, that is, the output pin will go high or low with each new temperature sample. The output is setup to be open drain to support wire-OR with multiple sensors or components.

The Si7060 powers up with a nominal temperature threshold of 79.8°C and reset threshold of 75°C, but these values are programmable.

The operation of the Si7060 is similar to industry standard parts, but offers lower power and in many cases higher accuracy. It is also capable of operating in autonomous sampling mode.

## Applications:

- HVAC/R
- Thermostats
- White Goods
- Computer Equipment
- Asset Tracking
- Battery Protection
- Industrial Controls

## FEATURES

- Better than  $\pm 1$  °C accuracy
- Better than  $\pm 0.1$  °C repeatability
- Wide operating voltage: 1.7 to 5.5 V
- Low power consumption: 500 nA
- Ultra-low power sleep mode: 50 nA
- I<sup>2</sup>C interface
- Configurable alert output
- 4 factory configurable I<sup>2</sup>C addresses
- Package Options:
  - SOT23-5

## 1. Functional Description

The Si7060 family of I<sup>2</sup>C temperature sensors measure and digitize the local temperature at the device. 4 modes of operation are possible:

### Sleep Mode:

This ultra-low power mode of operation is useful when temperature measurements are made infrequently and the lowest possible power is desired. In this mode, the part will remain in sleep mode until it receives a command over I<sup>2</sup>C to wake up and make a measurement. After this measurement, the part will go back to sleep.

The sleep bit is the 'master' bit. Once this bit is set, the sensor enters its sleep mode regardless of the other register configurations. Once the part is woken up by I<sup>2</sup>C, all registers are loaded to their default value, except for 0xC6 and 0xC7, which can be saved by the usestore bit.

### How to Configure:

sleep = 1

stop = X

sltimeena = X

### Autonomous Sampling Mode:

In this mode of operation, the device will make measurements at a factory set rate of 5 Hz (every 200 ms). By default the part enters the Autonomous Sampling Mode upon powerup. The sensor wakes up, performs a temperature conversion, updates the output accordingly, and then goes back to sleep.

### How to Configure:

sleep = 0

stop = 0

sltimeena = 1 (default state after wake-up)

### Active Mode:

In this mode of operation, measurements can be commanded, and the numerical value of the temperature can be read.

### How to Configure:

sleep = 0

stop = 0

sltimeena = X

oneburst = 1

The stop bit will be set to 1 once the measurement is complete.

**Table 1.1. Summary of Different States**

Mode	Sleep	Stop	Sltimeena
Sleep	1	x	x
Autonomous	0	0	1

The output pin is designed to be an open drain output, which allows you to connect multiple devices in parallel to trigger an alert. The output is driven low once the temperature crosses the operate point, and released once it goes below the release point. The temperature operate and release points are factory set to 80 °C and 75 °C but these values can be adjusted by setting the bit usestore to 1 and adjusting the data in registers 0xC6 and 0xC7 as will be described later. It is possible to adjust the output pin polarity so it goes high or low as temperature increases.

## 2. I2C Interface

The Si7060 complies with “fast” mode I<sup>2</sup>C operation and 7-bit addressing at speeds up to 400 kHz.

The I<sup>2</sup>C address is factory programmed to one of 4 values 0x30, 0x31, 0x32, or 0x33 (0110000b through 0110011b).

At power-up the registers are initialized, as will be described in the register definitions, and then they can be read or written in standard fashion for I<sup>2</sup>C devices.

The host command for writing an I<sup>2</sup>C register is:

START Address W ACK register ACK data ACK STOP

The host command for reading an I<sup>2</sup>C register is:

START Address W ACK register ACK Sr Address R Data NACK\* STOP

\*NACK by host

Where:

START is SDA going low with SCL high

Sr is a repeated START

Address is 0x30 up to 0x33.

0 indicates a write and 1 indicates a read.

ACK is SDA low.

Data is the Read or Write data.

NACK is SDA high.

STOP is SDA going high with SCL high.

Writing or Reading of sequential registers can be supported by setting the `arautoinc` bit of register 0xC5 (see register description). In the case of a read sequence where the `arautoinc` bit has been set, the data can be ACK'd to allow reading of sequential registers. For example, a two byte read of the conversion data in registers 0xC1 and 0xC2 would be:

START Address W ACK 0xC1 ACK Sr Address ACK data ACK\* data NACK\* STOP

\*ACK/NACK by host

To wake a part from sleep mode or to interrupt a measurement loop from idle mode, send the sequence:

START Address W ACK STOP

In this case, if the host continued with a register write, the Si7060 would NACK which would be unexpected. Additionally, the following sequence can be used to wake the part up or to interrupt a measurement loop:

START Address R ACK data NACK\* STOP

\*NACK by host

In this case, the Si7060 will produce 0xFF for the data. Allow for 10  $\mu$ sec between the ACK of the address and the next START for the Si7060 to wake from sleep. In most cases, this will happen automatically, due to the 400 KHz maximum speed of the I<sup>2</sup>C bus. The sequence will put the part in idle mode with the stop bit set.

To make a single conversion, having woken the part, set the `oneburst` bit of register 0xC4 to 1 and the `stop` bit to 0. The `stop` bit resets to 1 by the time the measurement is complete.

To put the part back to sleep after reading the data, set the `stop` bit to 0.

Putting the part to sleep with the `sleep` bit = 0 will result in the mode of operation where the temperature is sampled every 200 msec, and the output pin will toggle at the temperature threshold points as defined by registers 0xC6 and 0xC7 (assuming the `usestore` bit is also set)—that is, write 0x08 to 0xC4.

If ultra-low power sleep with no sampling is desired, set the `stop` bit to 0 and the `sleep` bit to 1—that is, write 0x00 or 0x09 (to retain the settings of 0xC6 and 0xC7) to 0xC4.

## 2.1 Operation at Very Slow I<sup>2</sup>C Bus Speeds

If the Si7060 is put to sleep with the sleep timer enabled, there will be one measurement done prior to sleep with the settings as configured in the wake period (i.e., operate and release points). This measurement starts at the falling edge of SCL prior to the ACK of the write that puts the part to sleep (i.e., writing 0x80 to register 0xC4). When the measurement concludes, the output pin will be set high or low depending on the measurement results, and the part will enter the sleep timer state.

In the sleep timer state, SDA will hold state until the next wake (either by host or due to the sleep timer, which is typically 200 msec). Thus, it is important that the ACK concludes prior to entering the sleep state, or SDA will hold low until the next wake. SDA is released at the falling edge of SCL, at the completion of the ACK time. This takes 140 µsec, and, therefore, the I<sup>2</sup>C clock speed must be fast enough that the time from SCL falling prior to ACK to SCL falling after ACK must be less than 140 µsec. Depending on the host timing for this portion of the I<sup>2</sup>C sequence, this corresponds to an I<sup>2</sup>C speed of greater than 7 KHz.

For very low I<sup>2</sup>C speeds, < 7KHz where this could be an issue, if the sleep timer function is not needed, write the sleep bit of register 0xC4 to put the part to sleep. If the sleep timer is not running, there is no measurement prior to sleep. SDA is released at the completion of the ACK, and the part will enter the sleep state without the sleep timer running.

## 2.2 Measuring Temperature Over I<sup>2</sup>C

The actual temperature of the device can be calculated by reading the Dpsigm and Dpsigl registers over I<sup>2</sup>C, which correspond to the most significant and least significant bytes of the temperature measurements respectively. The complete 15b unsigned result is  $256 * Dpsigm[6:0] + Dpsigl[7:0]$ .

A result of 16384 means the temperature is 55°C. More negative results mean lower temperature, and more positive results mean higher temperature. Temperature is calculated from the formula:

$$T (^{\circ}\text{C}) = 55 + (256 * Dpsigm[6:0] + Dpsigl[7:0] - 16384) / 160$$

Read the register interface section for more details.

### 3. Register Interface

The Si7060 has 9 registers. 0xC0 through 0xC9 not including 0xC3.

	7	6	5	4	3	2	1	0
0xC0	chipid (RO)				revid (RO)			
0xC1	Dpsigm							
0xC2	Dpsigl							
0xC3	Do not use							
0xC4	meas(RO)				usestore	oneburst	stop	sleep
0xC5								arautoinc
0xC6	sw_low4temp	sw_op						
0xC7	0x3			sw_hyst				
0xC8								
0xC9								slTimeena
0xE1	otp_addr							
0xE2	otp_data							
0xE3							otp_read	otp_busy

Registers 0xC0 through 0xC2 are read only registers. 0xC0 has the chip and revid information

*chipid (RO)* – This ID 0x1 for all Si7060 parts.

*revid (RO)* – This ID 0x4 for revision B.

0xC1 and 0xC2 store the result of a temperature conversion.

*Dpsigm* – Bits [6:0] are the most significant byte of the last conversion result. The most significant bit is a “fresh” bit, indicating the register has been updated since last read. Reading the *Dpsigm* register causes the register *Dpsigl* to be loaded with the least significant byte of the last conversion result.

*Dpsigl* – The least significant byte of the last conversion result. Read *Dpsigm* first to align the bytes. The complete 15b unsigned result is  $256 * Dpsigm[6:0] + Dpsigl[7:0]$ .

A result of 16384 means the temperature is 55°C. More negative results mean lower temperature, and more positive results mean higher temperature.

Temperature is calculated from the formula:

$$T (^{\circ}\text{C}) = 55 + (256 * Dpsigm[6:0] + Dpsigl[7:0] - 16384) / 160$$

This result can go from -47.4 to +157.39 °C. The recommended operating temperatures is -40°C to +125°C; so, the result should never be out of range, but if operated beyond the ratings of the part, the result will clamp at -47.4 to +157.39 °C (i.e., no underflow or overflow).

*Oneburst* – Setting this bit initiates a single conversion. Set stop = 0 when setting oneburst = 1. The stop bit will be set to 1 when the conversion completes.

*stop* - Setting this bit causes the control state machine measurement loop to pause after the current measurement burst completes. Once set, clearing this bit restarts the measurement loop.

*sleep* - Setting this bit causes the part to enter sleep mode after the current measurement burst completes. Once set, clearing this bit restarts the measurement loop.

*arautoinc* – enables auto increment of the I<sup>2</sup>C register address pointer. This bit is not retained in sleep mode.

*sw\_low4temp* - determines the polarity of the output pin. The default setting of *sw\_low4temp* = 1 means the pin will go low at high temperature, e.g. *sw\_op* + hysteresis. *sw\_low4temp* = 0 means the pin will go high at low temperature, e.g., *sw\_op* - hysteresis .

**Ustore** – Setting this bit causes the current state of OTP registers for the *sw\_op*, *sw\_hyst*, *sw\_low4field*, and *sw\_fieldpolsel* bits to be saved and restored during the next sleep and wakeup sequence instead of using the factory programmed default settings corresponding to 80°C set point and 75°C release point.

*sw\_op* – this 9 bit number sets the center point of the decision point for temperature high or low. The actual decision point is the center point plus or minus the hysteresis.

*sw\_op* of 256 corresponds to a decision point of 55°C. The decision point will go up or down by 0.4°C as *sw\_op* increases or decreases from this value.

$\text{threshold} = 55\text{C} + 0.4^\circ\text{C} * (\text{sw\_op} - 256)$

*sw\_hyst* - The formula for hysteresis is:

$\text{hysteresis} = 0.025^\circ\text{C} * (8 + \text{sw\_hyst}[2:0]) \times 2^{\text{sw\_hyst}[5:3]}$

When *sw\_hyst* = 63, the hysteresis is set to zero. These numbers can range from 0.2°C to 44.8°C

The operate point is threshold plus the hysteresis, and the release point is the threshold minus the hysteresis.

The factory default settings are *sw\_op* = 312 corresponding to a nominal decision point of 77.4°C and *sw\_hyst* = 28 corresponding to a nominal hysteresis of 2.4°C (operate at 79.8°C and release at 75°C).

*sTimeena* - Enables the sleep timer. 0 means the part goes into complete sleep once the sleep bit is set. 1 means the parts will wake a factory set interval between 1 and 200 msec, make a measurement, set the output pin value, and return to sleep.

The meas bit of 0xC4 indicates a measurement is in progress.

**Table 3.1. Si7060 OTP Memory Map**

ADDR	7	6	5	4	3	2	1	0
0x14	Base Part Number							
0x15	Part Number Variant							
0x18	Serial ID [31:24]							
0x19	Serial ID [23:16]							
0x1A	Serial ID [15:8]							
0x1B	Serial ID [7:0]							

*otp\_addr*: This is the OTP memory address to read.

*otp\_data*: This is the data contents of the OTP memory once it is read.

*otp\_read\_en*: This must be set to 1 to initiate an OTP Memory read sequence. The bit auto clears.

*otp\_busy*: This bit indicates if the OTP is busy. For normal I<sup>2</sup>C reads, the data will be available by the time the read enable bit is set and the data is read, so in most cases this bit is not needed.

Base part number: For the Si7060, the register value is 60.

Part number variant: The variant for the part number Si7060-B00 is 00. For the part number Si7060-B01, the part number variant is 01. The register value equals the part number variant.

## 4. Electrical Specifications

Unless otherwise specified, all min/max specifications apply over the recommended operating conditions

**Table 4.1. Recommended Operating Conditions**

Parameter	Symbol	Test Condition	Min	Typ	Max	Units
Power Supply	$V_{DD}$	—	1.71	—	5.5	V
Temperature	$T_A$	—	-40	—	125	°C

**Table 4.2. General Specifications**

Parameter	Symbol	Test Condition	Min	Typ	Max	Units	
Operating Supply Voltage on VDD	$V_{DD}$	—	1.71	—	5.5	V	
Operating Ambient Temperature	$T_A$	—	-40	—	125	°C	
Input Voltage Range	$V_{IN}$		0		$V_{DD}$	V	
Input Leakage	$I_{IL}$			<0.1	1	$\mu$ s	
Output Voltage Low	$V_{OL}$	SCL, SDA IOL = 3mA VDD > 2 V			0.4	V	
		SCL, SDA IOL = 2mA VDD > 1.7 V			0.2	V	
		SCL, SDA IOL = 6mA VDD > 2 V			0.6	V	
Current consumption	$I_{DD}$	Sleep timer enabled average $I_{DD}$ at VDD = 3.3V for sample rate = 200ms		0.5	1.5	$\mu$ A	
		Sleep mode (typ. 25°C)		50		nA	
		Sleep mode 125°C				1000	nA
		Conversion in progress/ Active Mode		-	-		$\mu$ A
		VDD = 3.3V		600	800		
		VDD = 5.5V		700	1000		
Conversion Time	$T_{CONV}$			143	160	$\mu$ s	
Sleep Time	$T_{SLEEP}$		160	200	240	$\mu$ s	
Wake Up Time	$T_{WAKE}$	Time from VDD > 1.7V to first measurement			1	ms	

Table 4.3. Output Pin Specifications

Parameter	Symbol	Test Condition	Min	Typ	Max	Units
Output Voltage Low	$V_{OL}$	$I_{OL} = 3\text{mA}; V_{DD} > 2\text{V}$			0.4	V
		$I_{OL} = 2\text{mA}; V_{DD} > 1.7\text{V}$			0.2	V
		$I_{OL} = 6\text{mA}; V_{DD} > 2\text{V}$			0.6	V
Leakage	$I_{LEAK}$	Output High			1	$\mu\text{A}$
Slew Rate	$T_{SLEW}$	Digital Output Mode		5		$\%V_{DD}/\text{ns}$

Table 4.4. I2C Interface Specifications

Parameter	Symbol	Test Condition	Min	Typ	Max	Units
SCL Clock Frequency	$f_{SCL}$		0		400	kHz
Start Condition Hold Time	$t_{SDH}$		0.6			$\mu\text{s}$
LOW Period of SCL	$t_{SKL}$		1.3			$\mu\text{s}$
HIGH Period of Clock	$t_{SKH}$		0.6			$\mu\text{s}$
Set Up Time for a Repeated Start	$t_{SU:STA}$		0.6			$\mu\text{s}$
Data Hold Time	$t_{DH}$		0			$\mu\text{s}$
Data Setup Time	$t_{DS}$		100			$\mu\text{s}$
Set Up Time for a STOP Condition	$t_{SPS}$		0.6			$\mu\text{s}$
Bus Free Time between STOP and START	$t_{BUF}$		1.3			$\mu\text{s}$
Data Valid Time (SCL Low to Data Valid)	$t_{VD:DAT}$				0.9	$\mu\text{s}$
Data Valid Acknowledge Time (time from SCL Low to SDA Low)	$t_{VD:ACK}$				0.9	$\mu\text{s}$
Hysteresis	$t_{HYST}$	Digital input hysteresis SDA and SCL	7		17	$\%V_{DD}$
Suppressed Pulse Width	$t_{SP}$	Pulses up to and including this limit will be suppressed	50			ns

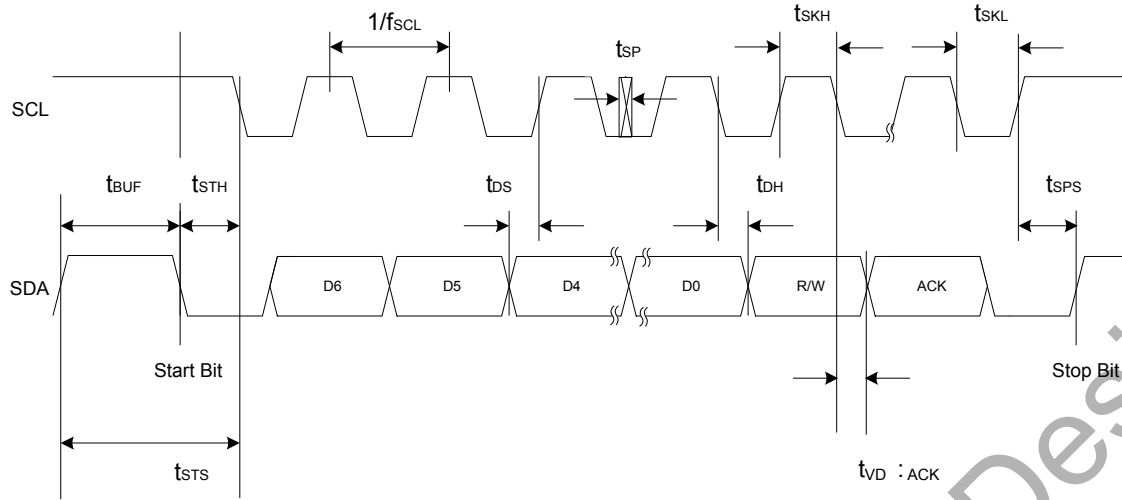

Figure 4.1. I<sup>2</sup>C Interface Timing

Table 4.5. Temperature Measurement Accuracy

Parameter	Symbol	Test Condition	Min	Typ	Max	Units
Temperature Measurement Accuracy	—	0°C to + 70°C		±0.5	±1	°C
		-40°C to + 125°C			±2	°C
Temperature Measurement Repeatability	—	RMS Noise		±0.05		°C RMS

Table 4.6. Thermal Characteristics

Parameter	Symbol	Test Condition	Value	Units
Junction to Air Thermal Resistance	$\theta_{JA}$	JEDEC 4 layer board no airflow SOT23-5	212.8	°C/W
Junction to Board Thermal Resistance	$\theta_{JB}$	JEDEC 4 layer board no airflow SOT23-5	45	°C/W

Table 4.7. Absolute Maximum Ratings

Parameter	Symbol	Test Condition	Min	Typ	Max	Units
Ambient Temperature Under Bias	—	—	-55		125	°C
Storage Temperature			-65		150	°C
Voltage on I/O Pins	$V_{IO}$		-0.3		$V_{DD}+0.3$	V
Voltage on VDD with respect to Ground	$V_{DD}$		-0.3		6	V
ESD Tolerance	$V_{HBM}$	Human Body Model			2	kV
	$V_{CDM}$	Charge Discharge Model			500	V

**Note:** Absolute maximum ratings are stress ratings only. Operation at or beyond these conditions is not implied and may shorten the life of the device, and/or alter its performance.

## 5. Ordering Guide

Part	I2C Address	Output Type
Si7060-B-00-IV(R)	0x30	Open Drain
Si7060-B-01-IV(R)	0x31	Open Drain
Si7060-B-02-IV(R)	0x32	Open Drain
Si7060-B-03-IV(R)	0x33	Open Drain

**Note:** The optional (R) is the designator for tape and reel (3000 pieces per reel). Parts not ordered by the full reel will be supplied in cut tape.

Not Recommended for New Designs

## 6. Pin Description

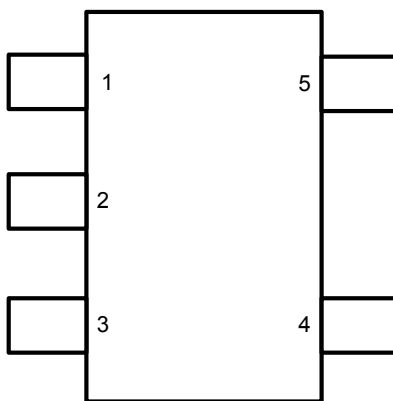

SOT-23, 5-Pin  
Top View

Figure 6.1. Pin Assignments

Table 6.1. 5-Pin SOT23-5 Package

Pin Name	Pin Number	Description
SDA	1	I <sup>2</sup> C data
GND	2	Ground
SCL	3	I <sup>2</sup> C clock
V <sub>DD</sub>	4	Power +1.7 to +5.5 V
ALERT	5	Digital output

## 7. Package Outline

### 7.1 SOT23-5 5-Pin Package

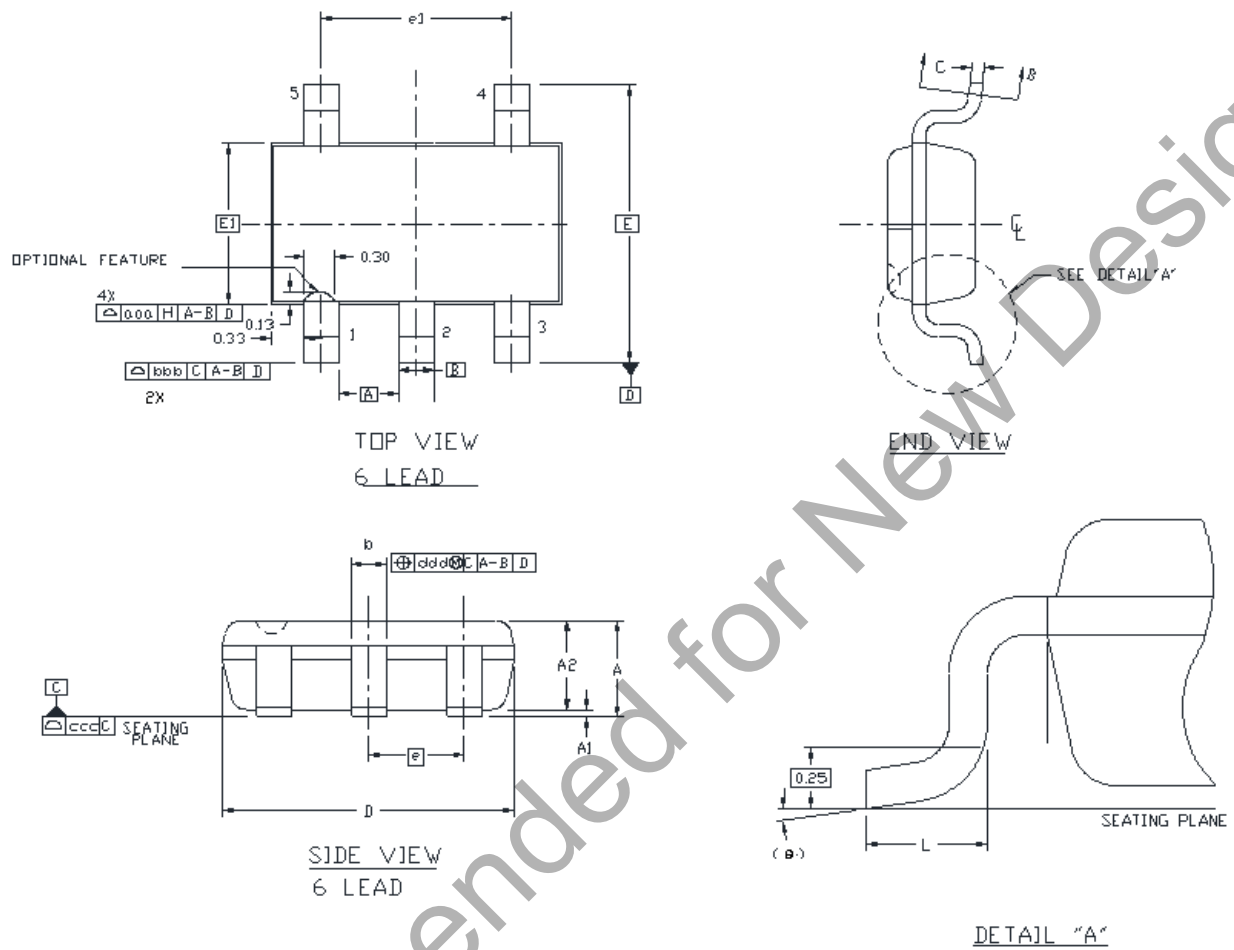
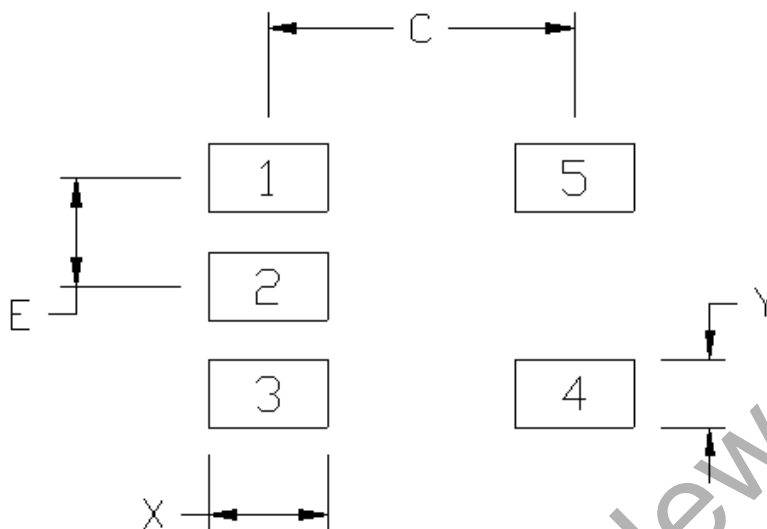

Table 7.1. SOT23-5 5-Pin Package Dimensions

Dimension	Min	Max
A	--	1.25
A1	0.00	0.10
A2	0.85	1.15
b	0.30	0.50
c	0.10	0.20
D	2.90 BSC	
E	2.75 BSC	
E1	1.60 BSC	
e	0.95 BSC	
e1	1.90 BSC	
L	0.30	0.60
L2	0.25 BSC	
$\theta$	0°	8°
aaa	0.15	
bbb	0.20	
ccc	0.10	
ddd	0.20	
<b>Note:</b>		
1. All dimensions shown are in millimeters (mm) unless otherwise noted.		
2. Dimensioning and Tolerancing per ANSI Y14.5M-1994.		
3. This drawing conforms to the JEDEC Solid State Outline MO-193, Variation AB.		
4. Recommended card reflow profile is per the JEDEC/IPC J-STD-020D specification for Small Body Components.		

## 8. Land Patterns

### 8.1 SOT23-5 5-Pin PCB Land Pattern



Dimension	(mm)
C	2.70
E	0.95
X	1.05
Y	0.60

**Note:**

**General**

1. All dimensions shown are in millimeters (mm) unless otherwise noted.
2. Dimensioning and Tolerancing is per the ANSI Y14.5M-1994 specification.
3. This Land Pattern Design is based on the IPC-7351 guidelines.
4. All dimensions shown are at Maximum Material Condition (MMC). Least Material Condition (LMC) is calculated based on a Fabrication Allowance of 0.05 mm.

**Card Assembly**

1. A No-Clean, Type-3 solder paste is recommended.
2. The recommended card reflow profile is per the JEDEC/IPC J-STD-020D specification for Small Body Components.

## 9. Top Marking

### 9.1 SOT23-5 5-Pin Top Marking

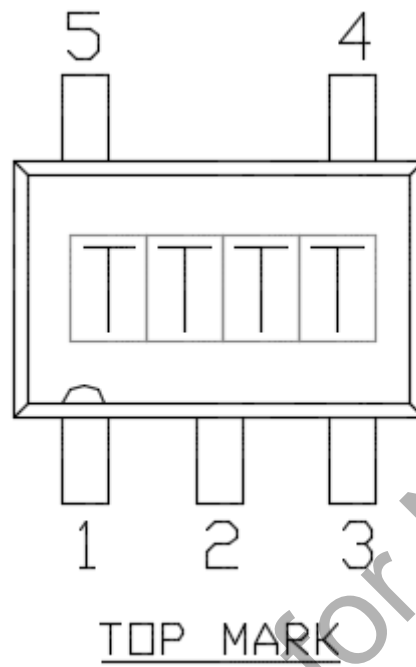

**Note:** TTTT is a manufacturing code.

## 10. Revision History

### Revision 0.1

May 2018

- Initial release.

Not Recommended for New Designs

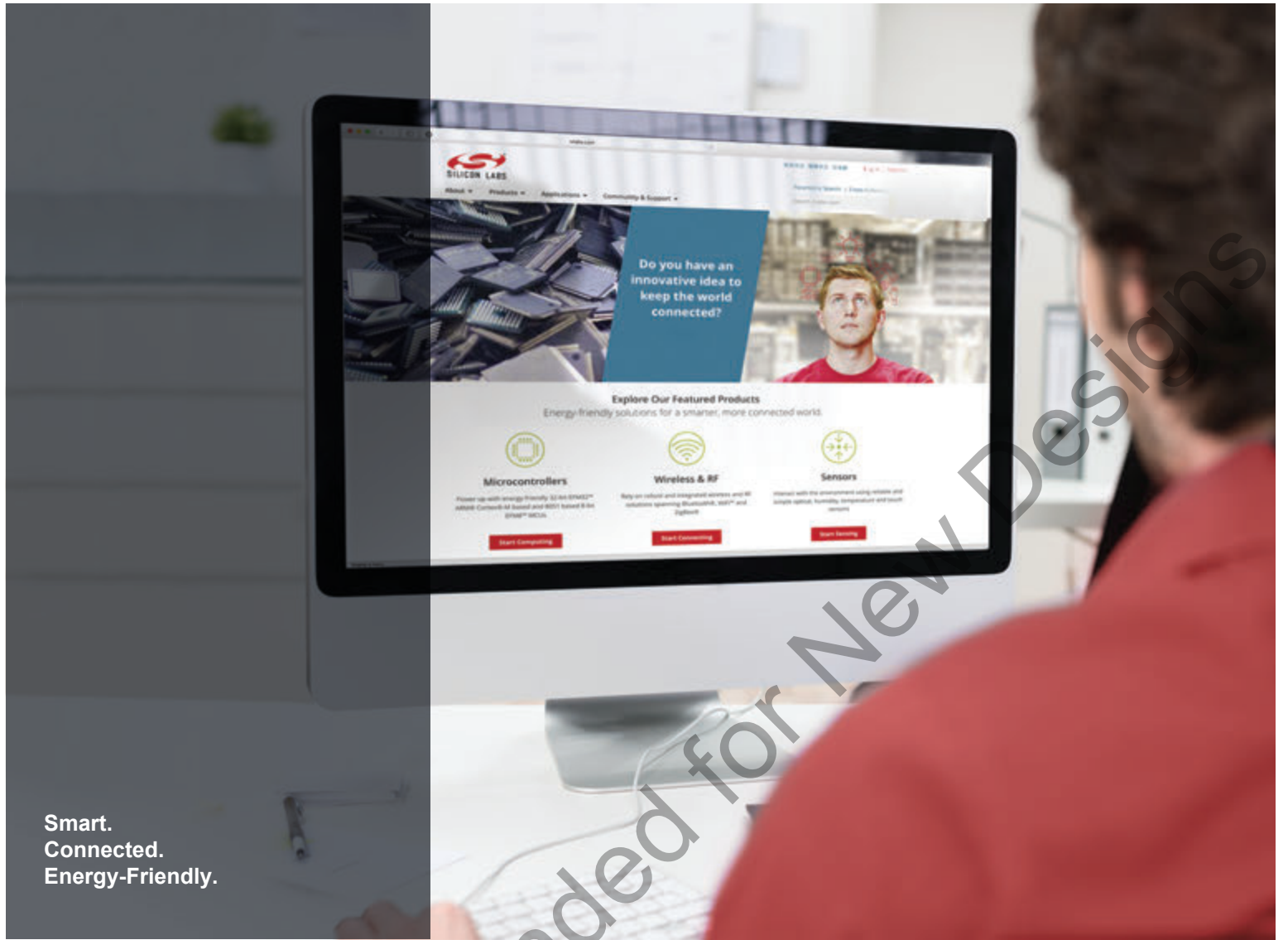

Smart.  
Connected.  
Energy-Friendly.



**Products**  
[www.silabs.com/products](http://www.silabs.com/products)

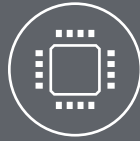

**Quality**  
[www.silabs.com/quality](http://www.silabs.com/quality)



**Support and Community**  
[community.silabs.com](http://community.silabs.com)

**Disclaimer**

Silicon Labs intends to provide customers with the latest, accurate, and in-depth documentation of all peripherals and modules available for system and software implementers using or intending to use the Silicon Labs products. Characterization data, available modules and peripherals, memory sizes and memory addresses refer to each specific device, and "Typical" parameters provided can and do vary in different applications. Application examples described herein are for illustrative purposes only. Silicon Labs reserves the right to make changes without further notice and limitation to product information, specifications, and descriptions herein, and does not give warranties as to the accuracy or completeness of the included information. Silicon Labs shall have no liability for the consequences of use of the information supplied herein. This document does not imply or express copyright licenses granted hereunder to design or fabricate any integrated circuits. The products are not designed or authorized to be used within any Life Support System without the specific written consent of Silicon Labs. A "Life Support System" is any product or system intended to support or sustain life and/or health, which, if it fails, can be reasonably expected to result in significant personal injury or death. Silicon Labs products are not designed or authorized for military applications. Silicon Labs products shall under no circumstances be used in weapons of mass destruction including (but not limited to) nuclear, biological or chemical weapons, or missiles capable of delivering such weapons.

**Trademark Information**

Silicon Laboratories Inc.®, Silicon Laboratories®, Silicon Labs®, SiLabs® and the Silicon Labs logo®, Bluegiga®, Bluegiga Logo®, Clockbuilder®, CMEMS®, DSPLL®, EFM®, EFM32®, EFR®, Ember®, Energy Micro, Energy Micro logo and combinations thereof, "the world's most energy friendly microcontrollers", Ember®, EZLink®, EZRadio®, EZRadioPRO®, Gecko®, ISOModem®, Micrium, Precision32®, ProSLIC®, Simplicity Studio®, SiPHY®, Telegesis, the Telegesis Logo®, USBXpress®, Zentri, Z-Wave and others are trademarks or registered trademarks of Silicon Labs. ARM, CORTEX, Cortex-M3 and THUMB are trademarks or registered trademarks of ARM Holdings. Keil is a registered trademark of ARM Limited. All other products or brand names mentioned herein are trademarks of their respective holders.



Silicon Laboratories Inc.  
400 West Cesar Chavez  
Austin, TX 78701  
USA

<http://www.silabs.com>

## Looking for pricing, stock, or lifecycle information?

Click below to explore more details on WIN SOURCE:

 [View SI7060-B-01-IVR on WIN SOURCE](#)

 [Silicon Labs](#) Information

## Optimize Your Supply Chain with WIN SOURCE Solutions

-  Global Sourcing Solution
-  Obsolete Management
-  Cost Control Management
-  Shortage Management
-  Alternative Solution
-  Excess Inventory Management