



**THE DATASHEET OF
SPTMA0300PG5W02**



SPT Series

Low Cost, Stainless Steel Media Isolated Pressure Sensors



DESCRIPTION

Honeywell's SPT Series stainless steel pressure sensors are designed for media that will not adversely attack 316L stainless steel.

The back side metal tube is made from 304 stainless steel which provides effective protection against most harsh environments. The SPT Series is calibrated and compensated for three styles of output: 4.0 mA to 20.0 mA (mA version); 1.0 Vdc to 5.0 Vdc (4 V version); and 0 mV to 100 mV (mV version).

FEATURES

- Reliable semiconductor technology
- Calibrated and temperature compensated
- Rugged, stainless steel package
- NEMA 4 design
- Small size
- Absolute, gage, sealed gage, vacuum gage pressures
- 0 psi to 3 psi, 0 psi to 5000 psi

All versions feature a variety of pressure connections to allow use in a wide range of OEM (Original Equipment Manufacturer) equipment.

The SPT Series stainless steel devices are rugged and reliable transducers for use in a wide variety of pressure sensing applications where corrosive liquids and gases are monitored.

POTENTIAL APPLICATIONS

- Industrial automation and flow control
- Pressure instrumentation
- Hydraulic systems
- Process control

SPT Series

Table 1. Specifications

Characteristic	Parameter
Environmental specifications	
Compensated temperature range	-10 °C to 85 °C [14 °F to 185 °F]
Operating temperature range	-40 °C to 85 °C [-40 °F to 185 °F]
Storage temperature range	-40 °C to 85 °C [-40 °F to 185 °F]
Vibration	10 G at 20 Hz to 2000 Hz
Shock	100 G for 11 ms
Insulation resistance	100 MΩ at 50 Vdc
Recommended supply range	
SPT mA supply voltage	+12.5 Vdc to +24 Vdc
SPT 4V	
Supply voltage V_s	+12.5 Vdc to +24 Vdc
Quiescent current I_{osc}	5 mA
Short circuit current I_{sc}	18 mA
SPT mV supply voltage V_s	+10 Vdc
Maximum supply ratings	
SPT mV supply voltage V_s	+15 Vdc
SPT mA and SPT 4V supply voltage V_s	+24 Vdc

Table 2. Pressure Range Specifications

Catalog Listing ¹	Pressure Range	Proof Pressure ²	Burst Pressure ³
SPT (mA, mV, 4V) 0003P G (4,5,6,7,9) (B/WXX)	0 psig to 3 psig	9 psig	15 psig
SPT (mA, mV, 4V) 0005P G (4,5,6,7,9) (B/WXX)	0 psig to 5 psig	15 psig	25 psig
SPT (mA, mV, 4V) 0010P G (4,5,6,7,9) (B/WXX)	0 psig to 10 psig	30 psig	50 psig
SPT (mA, mV, 4V) 0015P (A,G,V) (4,5,6,7,9) (B/WXX)	0 psi to 15 psi	45 psi	75 psi
SPT (mA, mV, 4V) 0030P (A,G,V) (4,5,6,7,9) (B/WXX)	0 psi to 30 psi	90 psi	150 psi
SPT (mA, mV, 4V) 0050P (A,G,V) (4,5,6,7,9) (B/WXX)	0 psi to 50 psi	150 psi	250 psi
SPT (mA, mV, 4V) 0100P (A,G,V) (4,5,6,7,9) (B/WXX)	0 psi to 100 psi	300 psi	500 psi
SPT (mA, mV, 4V) 0200P (A,G,V) (4,5,6,7,9) (B/WXX)	0 psi to 200 psi	600 psi	1000 psi
SPT (mA, mV, 4V) 0300P (A,G,V) (4,5,6,7,9) (B/WXX)	0 psi to 300 psi	900 psi	1500 psi
SPT (mA, mV, 4V) 0500P (A,G,V) (4,5,6,7,9) (B/WXX)	0 psi to 500 psi	1200 psi	2400 psi
SPT (mA, mV, 4V) 1000P (A,S) (4,5,6,7) (B/WXX)	0 psi to 1000 psi	3000 psia	5000 psia
SPT (mA, mV, 4V) 2000P (A,S) (4,5,6,7) (B/WXX)	0 psi to 2000 psi	6000 psia	10000 psia
SPT (mA, mV, 4V) 3000P (A,S) (4,5,6,7) (B/WXX)	0 psi to 3000 psi	9000 psia	10000 psia
SPT (mA, mV, 4V) 5000P (A,S) (4,5,6,7) (B/WXX)	0 psi to 5000 psi	10000 psia	10000 psia

Notes:

1. Vacuum gage units (V option) allow you to pull a hard vacuum on the gage units. Vacuum gage parts are only available on the mV version in 15 psig through 500 psig. As sold, this package design is not submersible. In order to make the package submersible, the package needs to be sealed.
2. The maximum pressure that can be applied without changing the transducer's performance or accuracy.
3. The maximum pressure that can be applied to a transducer without rupture of either the sensing element or transducer case.

Low Cost, Stainless Steel Media Isolated Pressure Sensors

Table 3. Performance Specifications¹

Characteristic	Minimum	Typical	Maximum	Unit
SPT mV Version				
Zero pressure offset	-2	0	+2	mV
Full-scale span (0 psig to 3 psig and 0 psig-5 psig only) ²	48	50	52	mV
Full-scale span (0 psi to 10 psi and 0 psi to 3000 psi only) ²	98	100	102	mV
Full-scale span (0 psi to 5000 psi only) ²	148	150	152	mV
Pressure non-linearity ³	–	±0.1	±0.25	%FSS
Pressure hysteresis ³	–	±0.015	±0.030	%FSS
Repeatability	–	±0.010	±0.030	%FSS
Temp. effect on span ⁴	–	±0.5	±1.0	%FSS
Temp. effect on offset ⁴	–	±0.5	±1.0	%FSS
Temp. effect on span (0 psi to 3 psi and 0 psi to 5 psi only) ⁴	–	±1	±2.0	%FSS
Temp. effect on offset (0 psi to 3 psi and 0 psi to 5 psi only) ⁴	–	±1	±2.0	%FSS
Thermal hysteresis (-10 °C to 85 °C [14 °F to 185 °F])	–	±0.1	±0.3	%FSS
Long-term stability of offset and span ⁵	–	±0.1	±0.3	%FSS
Response time ⁶	–	0.1	–	ms
Common mode voltage (voltage version “K”) ⁷	0.5	1.25	2.0	Vdc
Input resistance	8.0	25	50	kΩ
Output resistance	3.0	4.5	6.0	kΩ
SPT mA Version				
Zero pressure offset	3.84	4.0	4.16	mA
Full-scale span ²	15.84	16.0	16.16	mA
Pressure non-linearity ³	–	±0.1	±0.25	%FSS
Pressure hysteresis ³	–	±0.015	±0.03	%FSS
Repeatability	–	±0.010	±0.030	%FSS
Temp. effect on span ⁴	–	±0.5	±1.5	%FSS
Temp. effect on offset ⁴	–	±0.5	±1.5	%FSS
Temp. effect on span (0 psi to 3 psi and 0 psi to 5 psi only) ⁴	–	±1.5	±2.5	%FSS
Temp. effect on offset (0 psi to 3 psi and 0 psi to 5 psi only) ⁴	–	±1.5	±2.5	%FSS
Thermal hysteresis -10 °C to 85 °C [14 °F to 185 °F]	–	±0.1	±0.3	%FSS
Long term stability of offset and span ⁵	–	±0.1	±0.3	%FSS
Response time ⁶	–	5	–	ms
SPT 4V Version				
Zero pressure offset	0.96	1.0	1.04	V
Full-scale span ²	3.96	4.0	4.04	V
Pressure non-linearity ³	–	±0.1	±0.25	%FSS
Pressure hysteresis ³	–	±0.015	±0.03	%FSS
Repeatability	–	±0.010	±0.030	%FSS
Temp. effect on span ⁴	–	±0.5	±1.5	%FSS
Temp. effect on offset ⁴	–	±0.5	±1.5	%FSS
Temp. effect on span (0 psi to 3 psi and 0 psi to 5 psi only) ⁴	–	±1.5	±2.5	%FSS
Temp. effect on offset (0 psi to 3 psi and 0 psi to 5 psi only) ⁴	–	±1.5	±2.5	%FSS
Thermal hysteresis -10 °C to 85 °C [14 °F to 185 °F]	–	±0.1	±0.3	%FSS
Long term stability of offset and span ⁵	–	±0.1	±0.3	%FSS
Response time ⁶	–	5	–	ms

Notes:

- Reference conditions (unless otherwise noted): $T_A = 25\text{ °C}$ [77 °F]; For SPTmA and SPT4V, Supply $V_s = 23.5\text{ Vdc} \pm 0.01\text{ Vdc}$; for SPTmV: $V_s = 10\text{ Vdc}$.
- Full-scale span (FSS) is the algebraic difference between the output voltage at full-scale positive pressure and the output at zero pressure. FSS is ratiometric to the supply voltage.
- Pressure non-linearity is based on best-fit straight line from zero to the full-scale pressure. Pressure hysteresis is the maximum output difference at any point within the operating pressure range for increasing and decreasing pressure.
- Maximum error band of the offset voltage or span over the compensated temperature range, relative to the 25 °C [77 °F] reading.
- Long-term stability over a six-month period.
- Response time for a 0 psi to FSS pressure step change, 10% to 90% rise time.
- Common mode voltage as measure from output to ground.

Figure 1. Equivalent Basic Circuits

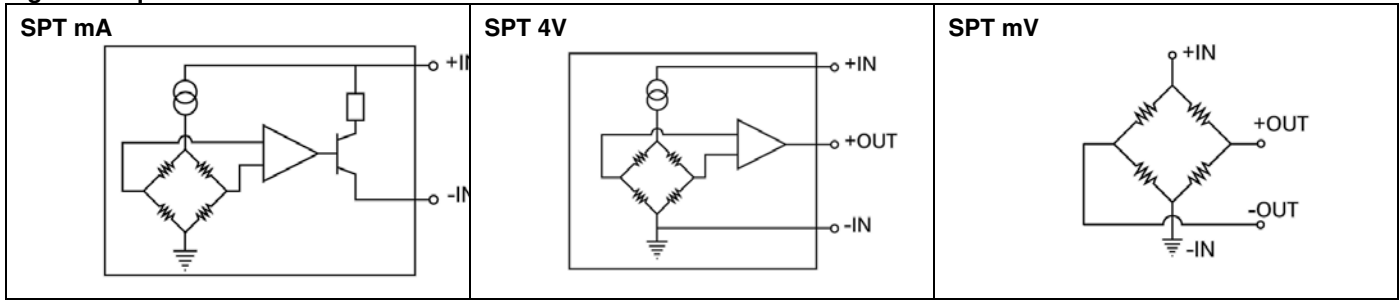

Figure 2. SPT mA Version External Load Line

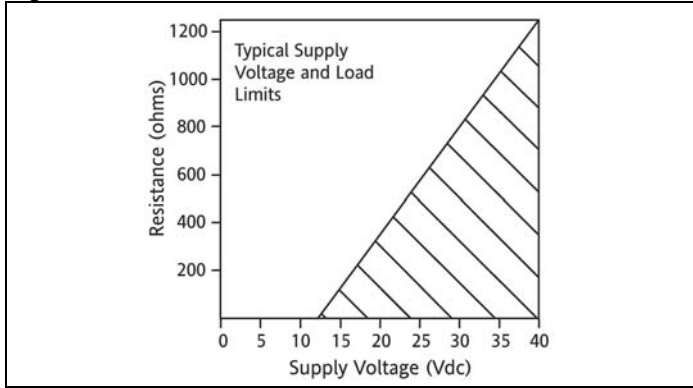

Figure 3. Pinout and Wire Code for all Package Styles

PIN DESIGNATIONS			
PIN LTR	mA	4V	mV
A	+IN	+IN	+IN
B	N/C	+OUT	+OUT
C	N/C	N/C	-OUT
D	-IN	-IN	-IN

WIRE CODE			
Color	mA	4V	mV
RED	+IN	+IN	+IN
BLACK	-IN	-IN	-IN
GREEN	N/C	+OUT	+OUT
WHITE	N/C	N/C	-OUT
BARE	SHIELD	SHIELD	SHIELD

MOUNTING DIMENSIONS (For reference only, in (mm).)

Figure 4: Package 4: 1/8-27 NPT Port

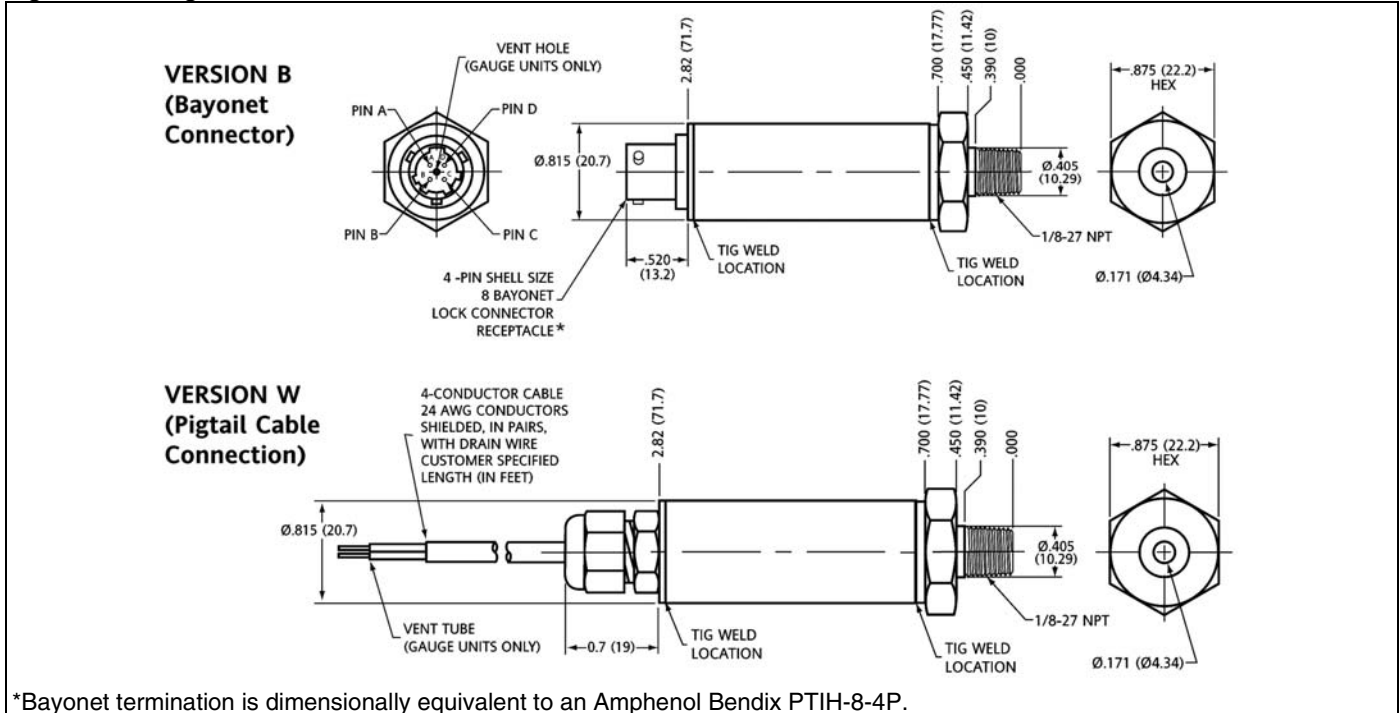

Low Cost, Stainless Steel Media Isolated Pressure Sensors

Figure 5. Package 5: 1/4-18 NPT Port

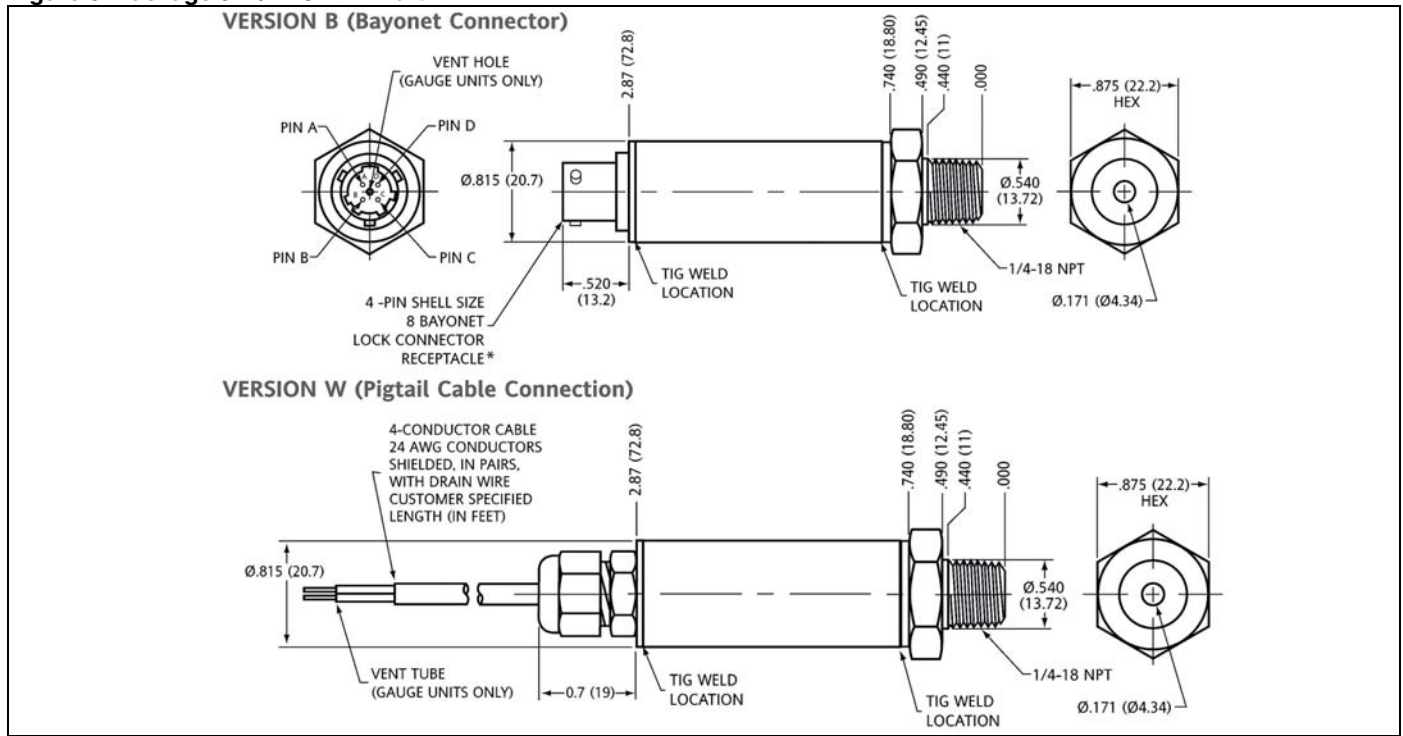
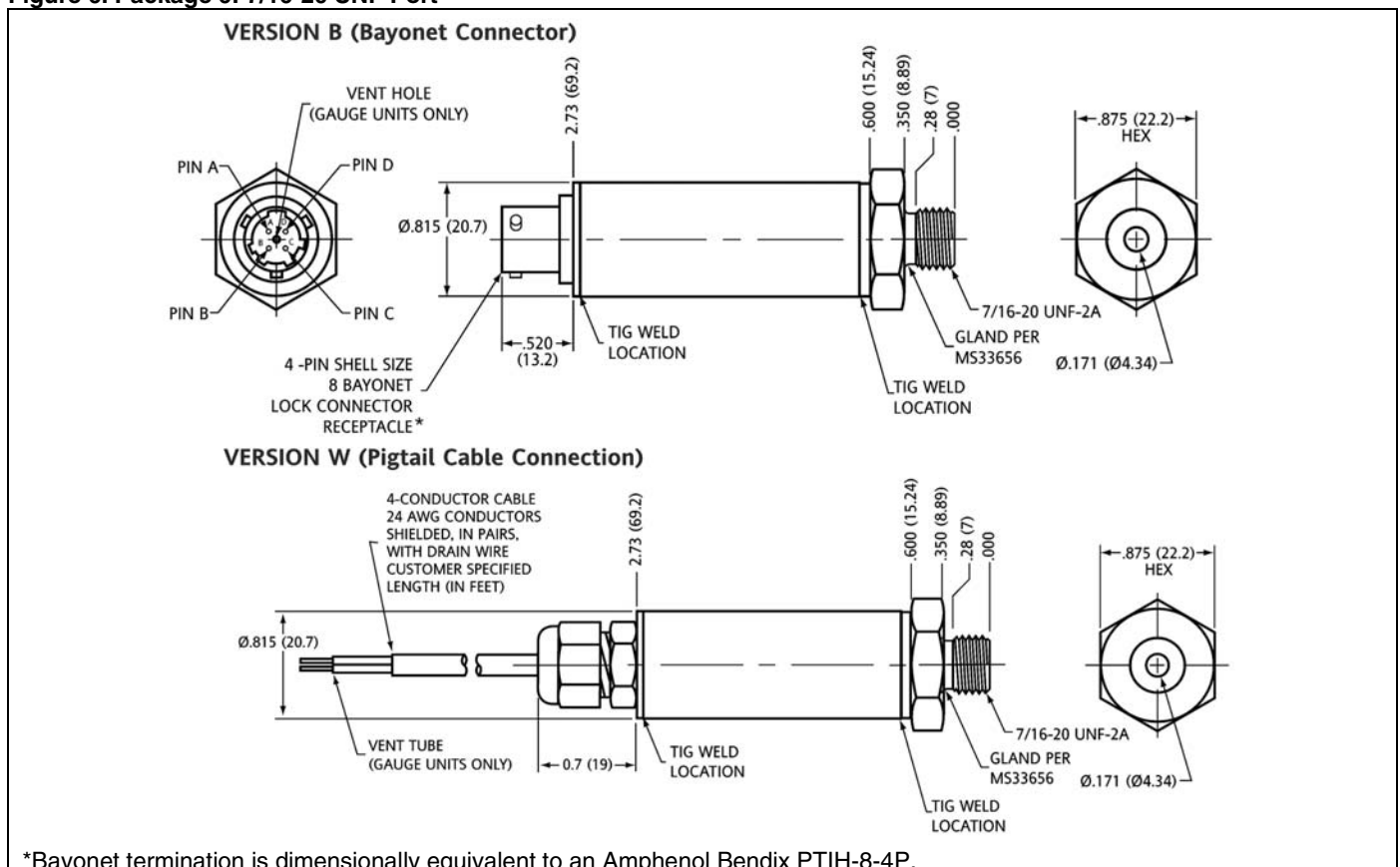

Figure 6. Package 6: 7/16-20 UNF Port



*Bayonet termination is dimensionally equivalent to an Amphenol Bendix PTIH-8-4P.

Figure 7. Package 7: 1/4-19 BSPP Port

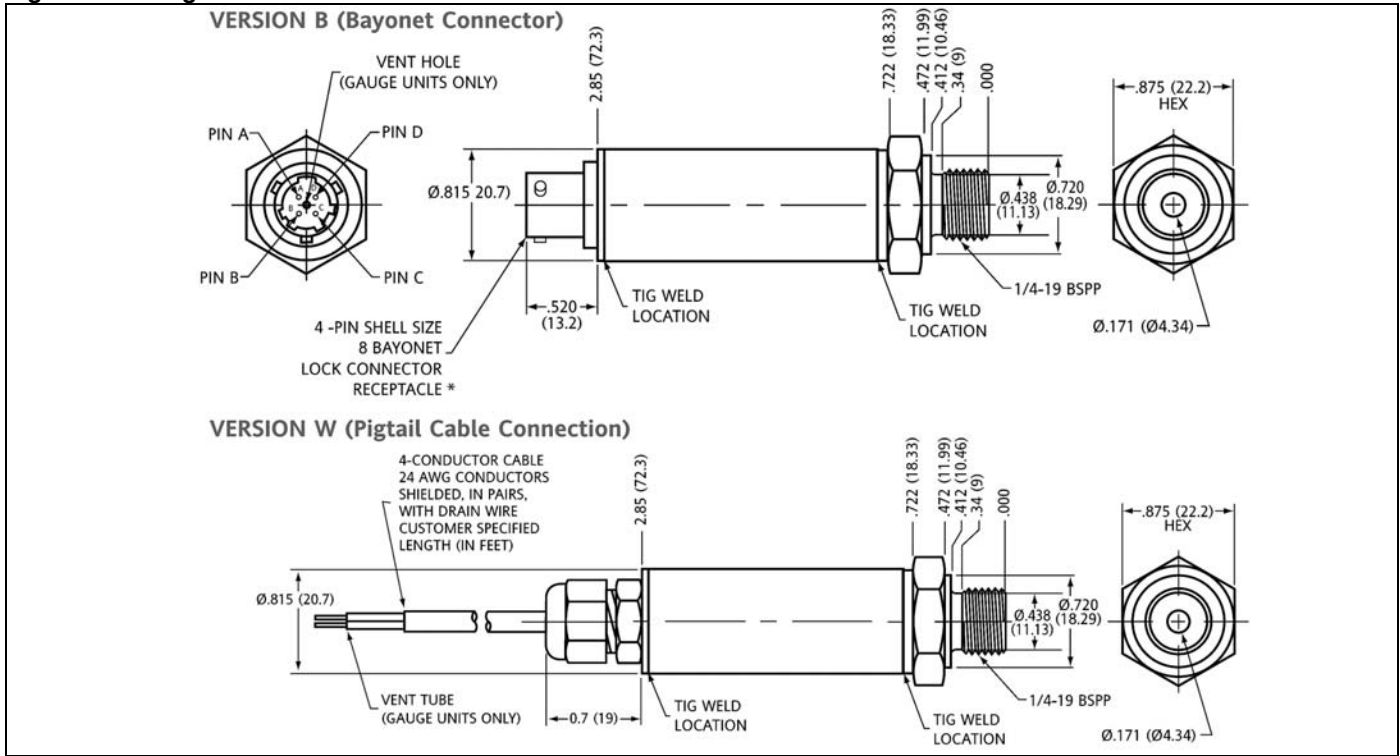
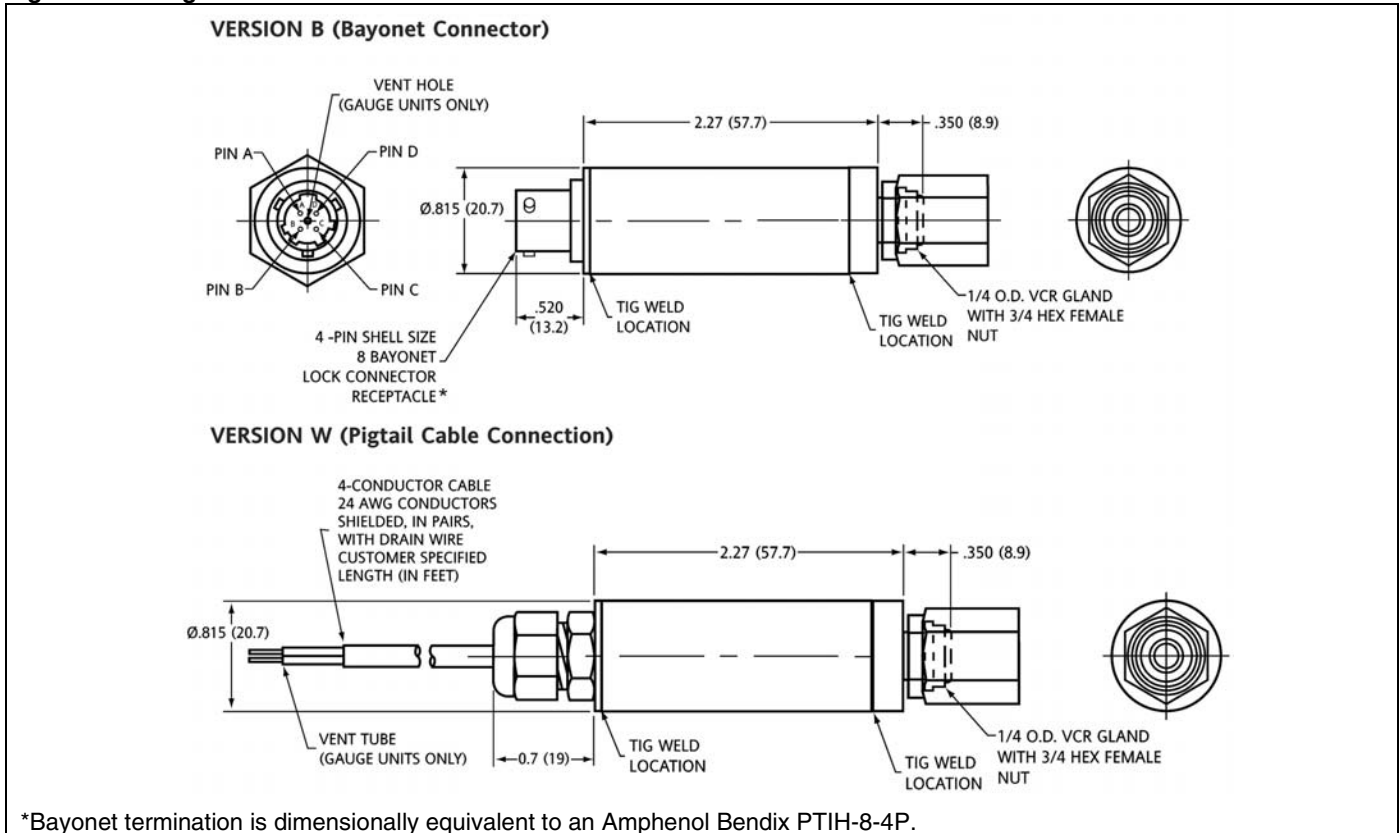

Figure 8. Package 9: VCR Port



Low Cost, Stainless Steel Media Isolated Pressure Sensors

Order Guide

SPT mA

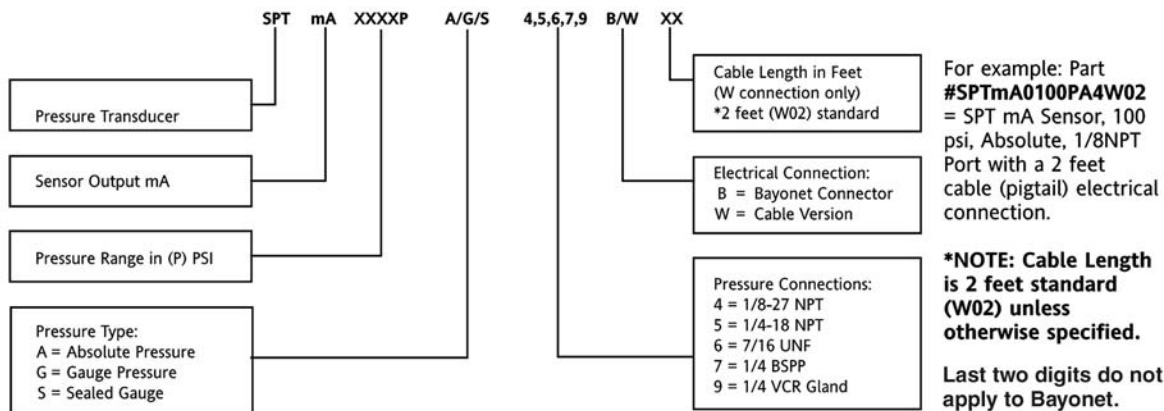

SPT mV

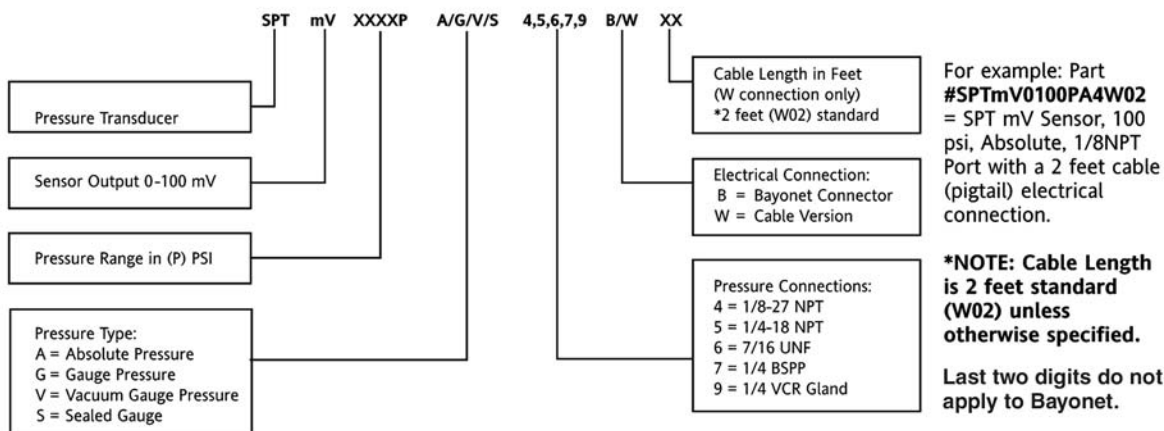

SPT 4V

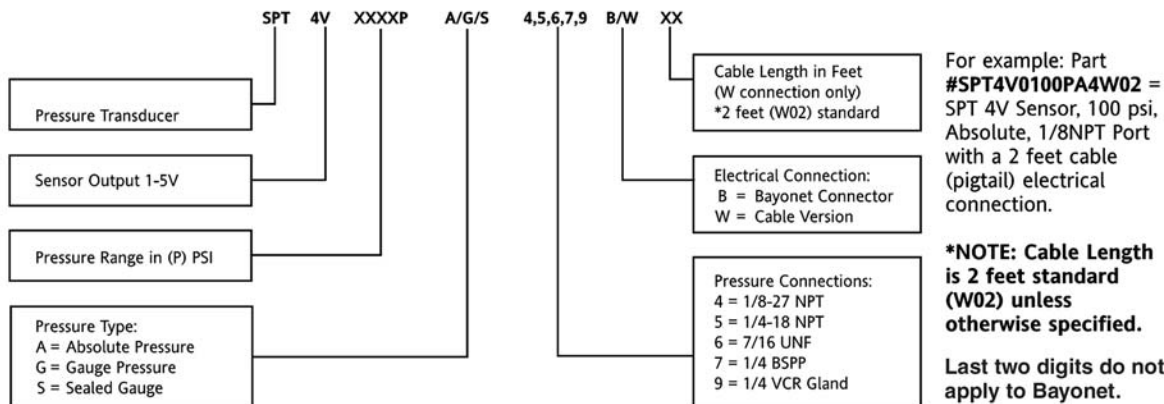

WARNING

PERSONAL INJURY

DO NOT USE these products as safety or emergency stop devices or in any other application where failure of the product could result in personal injury.

Failure to comply with these instructions could result in death or serious injury.

WARRANTY/REMEDY

Honeywell warrants goods of its manufacture as being free of defective materials and faulty workmanship. Honeywell's standard product warranty applies unless agreed to otherwise by Honeywell in writing; please refer to your order acknowledgement or consult your local sales office for specific warranty details. If warranted goods are returned to Honeywell during the period of coverage, Honeywell will repair or replace, at its option, without charge those items it finds defective. **The foregoing is buyer's sole remedy and is in lieu of all other warranties, expressed or implied, including those of merchantability and fitness for a particular purpose. In no event shall Honeywell be liable for consequential, special, or indirect damages.**

While we provide application assistance personally, through our literature and the Honeywell web site, it is up to the customer to determine the suitability of the product in the application.

Specifications may change without notice. The information we supply is believed to be accurate and reliable as of this printing. However, we assume no responsibility for its use.

WARNING

MISUSE OF DOCUMENTATION

- The information presented in this product sheet is for reference only. Do not use this document as a product installation guide.
- Complete installation, operation, and maintenance information is provided in the instructions supplied with each product.

Failure to comply with these instructions could result in death or serious injury.

SALES AND SERVICE

Honeywell serves its customers through a worldwide network of sales offices, representatives and distributors. For application assistance, current specifications, pricing or name of the nearest Authorized Distributor, contact your local sales office or:

E-mail: info.sc@honeywell.com

Internet: www.honeywell.com/sensing

Phone and Fax:

Asia Pacific +65 6355-2828
+65 6445-3033 Fax
Europe +44 (0) 1698 481481
+44 (0) 1698 481676 Fax
Latin America +1-305-805-8188
+1-305-883-8257 Fax
USA/Canada +1-800-537-6945
+1-815-235-6847
+1-815-235-6545 Fax

Sensing and Control
Honeywell
1985 Douglas Drive North
Golden Valley, MN 55422
www.honeywell.com/sensing

008133-2-EN IL50 GLO Printed in USA
August 2009
Copyright © 2009 Honeywell International Inc. All rights reserved.

Honeywell

Looking for pricing, stock, or lifecycle information?

Click below to explore more details on WIN SOURCE:

 [View SPTMA0300PG5W02 on WIN SOURCE](#)

 [Honeywell Information](#)

Optimize Your Supply Chain with WIN SOURCE Solutions

-  Global Sourcing Solution
-  Obsolete Management
-  Cost Control Management
-  Shortage Management
-  Alternative Solution
-  Excess Inventory Management