

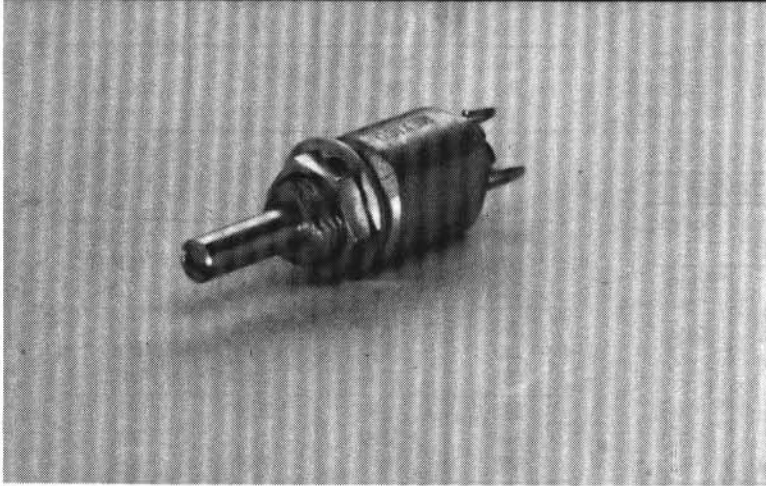

**THE DATASHEET OF  
SPSG040F103X**



Type SP  
**Cermet Panel  
Potentiometers**



**Features** \_\_\_\_\_

- 0.375 Inch (9,25mm) Diameter .....
- 1 Watt @ 70°C .....
- TCR  $\pm 100$  PPM/C .....
- Immersion Sealed .....

**Benefits** \_\_\_\_\_

- Small Size
- High Power Capabilities
- Temperature Stable
- Washable

**AVAILABILITY**

**Groupings** \_\_\_\_\_

The Type SP Cermet Panel Potentiometers are divided into two groups.

**OEM standard components**— These OEM components (Bushing/Resistance/Taper Combinations and Bushing/Shaft/Taper Combinations, listed in the table on Page 237) are stocked as components at our manufacturing facilities. They offer a wider range of possible combinations than

the distributor stocked potentiometers but do require assembly.

**All custom components**— All other components listed are available. Since they are not stocked, they require both fabrication and assembly. Contact factory for information.

## SPECIFICATIONS

### General

---

**Temperature range** –  $-65^{\circ}\text{C}$  to  $+150^{\circ}\text{C}$ .

**Total resistance values** – 50 ohms to 1 megohm.

**Total resistance tolerances** –  $\pm 5\%$ ,  $\pm 10\%$ .

**Taper – (Resistance – rotation characteristics)** – “U” linear taper.

**End resistance** – Less than 5 ohms at both ends.

### Electrical

---

**Power** – 1 watt maximum at  $+70^{\circ}\text{C}$  provided voltage rating is not exceeded.

**Power derating** – Derate power linearly from  $+70^{\circ}\text{C}$  to zero at  $+150^{\circ}\text{C}$ . Derate power 50 percent for non-metallic mounting. For rheostat applications, derate power directly with shaft or actuator position.

**Voltage** – 300 volts maximum working voltage (RMS or DC), or as determined by  $E_{\text{max.}} = \sqrt{PR}$ , whichever is less (at sea level).

**Dielectric withstanding voltage** – Will withstand a one second test of 750 volts RMS at sea level, or 350 volts RMS at 3.4 inches (86,36 mm) mercury.

**Insulation resistance** – 100 megohms minimum for clean and dry conditions at  $+25^{\circ}\text{C}$ .

### Operational

---

**Contact resistance variation** – Less than 3 percent of nominal resistance value.

**Load life** – 5 percent maximum change in total resistance as a result of a 1000 hour test at rated power across entire

element in still air at  $+70^{\circ}\text{C}$  (1.5 hours “ON”, 0.5 hour “OFF”).

**Rotational life** – 10 percent maximum change in total resistance as a result of 25,000 mechanical cycles under load.

### Mechanical

---

**Construction** – Materials are essentially non-magnetic. Terminals are treated for easy soldering. The resistor incorporates an internal “O” ring between the shaft and bushing. External surfaces are given special treatment so that the entire unit is immersion sealed.

**Shafts** – Diameter of shafts .125 inch (3,18 mm). Minimum length .188 inch (4,76 mm). Maximum length 2.500 inches (63,50 mm).

Other shaft lengths available in 1/64 inch (0,40 mm) increments. All shaft lengths are measured from the mounting face of the resistor to the free end of the shaft.

**Bushings** – All bushings have a 32-NEF-2A thread and are .250 inch (6,35 mm) in diameter.

All bushing lengths are measured from the mounting face to the end of the bushing.

**Turning torque** – 0.5 to 6 inch-ounces (0,036 to 0,44 kgf-cm) at  $+25^{\circ}\text{C}$ .

**Stop torque** – 3 inch-pounds (3,46 kgf-cm) minimum.

**Rotation** – Mechanical rotation is  $280^{\circ} \pm 5^{\circ}$ . Electrical rotation is  $240^{\circ}$  nominal.

**Backlash** – Maximum of 3 degrees.

**Weight** – Approximately 5 grams.

**Locating lugs** – Seven locating lugs are available so the resistor may be indexed with respect to the surface on which it is mounted. Double flatted bushings and lug adapters accomplish this function. All lug adapters shipped in bulk. Unless otherwise specified, resistors are supplied in accordance with Option No. 2. See dimensions.

**Hardware** – Standard hardware is one mounting nut M-4721 and one internal tooth lock washer M-4748. Unless otherwise specified, all hardware shipped in bulk.

**Marking** – Clarostat part number and nominal total resistance are marked in two lines. Other marking possible, limited to a maximum of 13 characters in each of two lines. “Type SP” always included.

## Environmental

**Vibration** — 2 percent maximum change in total resistance, 5 percent maximum change in resistance setting. (Tested per method 204, condition “C” of MIL-STD-202.)

**Shock** — 2 percent maximum change in total resistance. 5 percent maximum change in resistance setting. (Tested per method 213, condition “I” of MIL-STD-202.)

**Moisture resistance** — 2 percent maximum change in total resistance. (Method 106 of MIL-STD-202.)

**Effect of soldering** — 1 percent maximum change in total resistance as a result of immersing the terminals in 350°C solder to within 0.062 inch (1,59 mm) of the resistor for  $5 \pm \frac{1}{2}$  seconds.

**Temperature cycling** — 3 percent maximum change in total resistance as a result of the temperature cycling test. (Five cycles at  $-65^{\circ}\text{C}$  to  $+150^{\circ}\text{C}$ .)

**High temperature exposure** — 4 percent maximum change in total resistance as a result of the high temperature exposure test. ( $+150^{\circ}\text{C}$  for 1000 hours without load.)

**Low temperature operation** — 2 percent maximum change in total resistance as a result of the low temperature operation test. ( $-65^{\circ}\text{C}$  for two hours without load and 45 minutes with rated load.)

**Temperature coefficient** — Total resistance change less than  $\pm 100$  ppm/ $^{\circ}\text{C}$ . (Tested per method 304 of MIL-STD-202.)

**Immersion** — No continuous stream of bubbles (4 or more) emanating from the resistor as a result of the immersion test (1 minute in water at  $+85^{\circ}\text{C}$ ).

**Washability** — Capable of withstanding conventional after-solder boardwash processes using approved detergent or solvent solutions.

## Taper Data

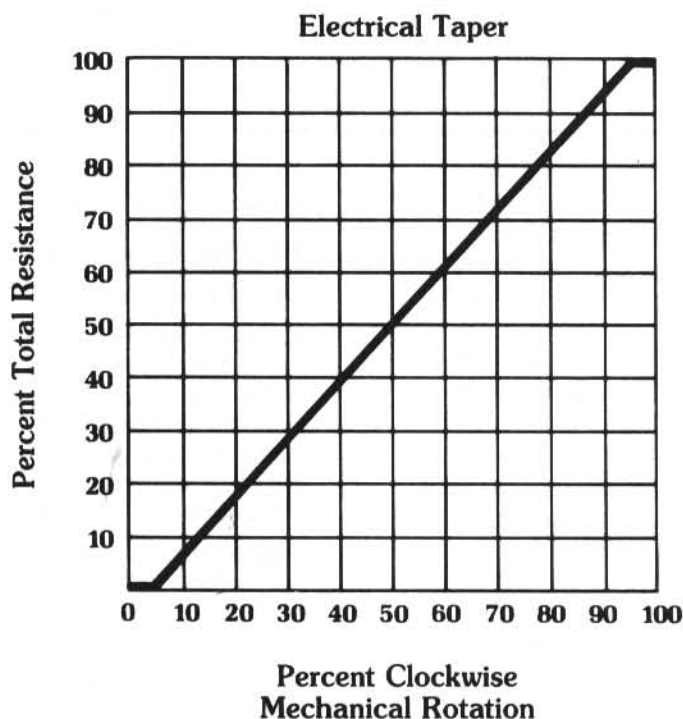

TYPE SP

# Cermet Panel Potentiometers

## Explanation of Part Numbers

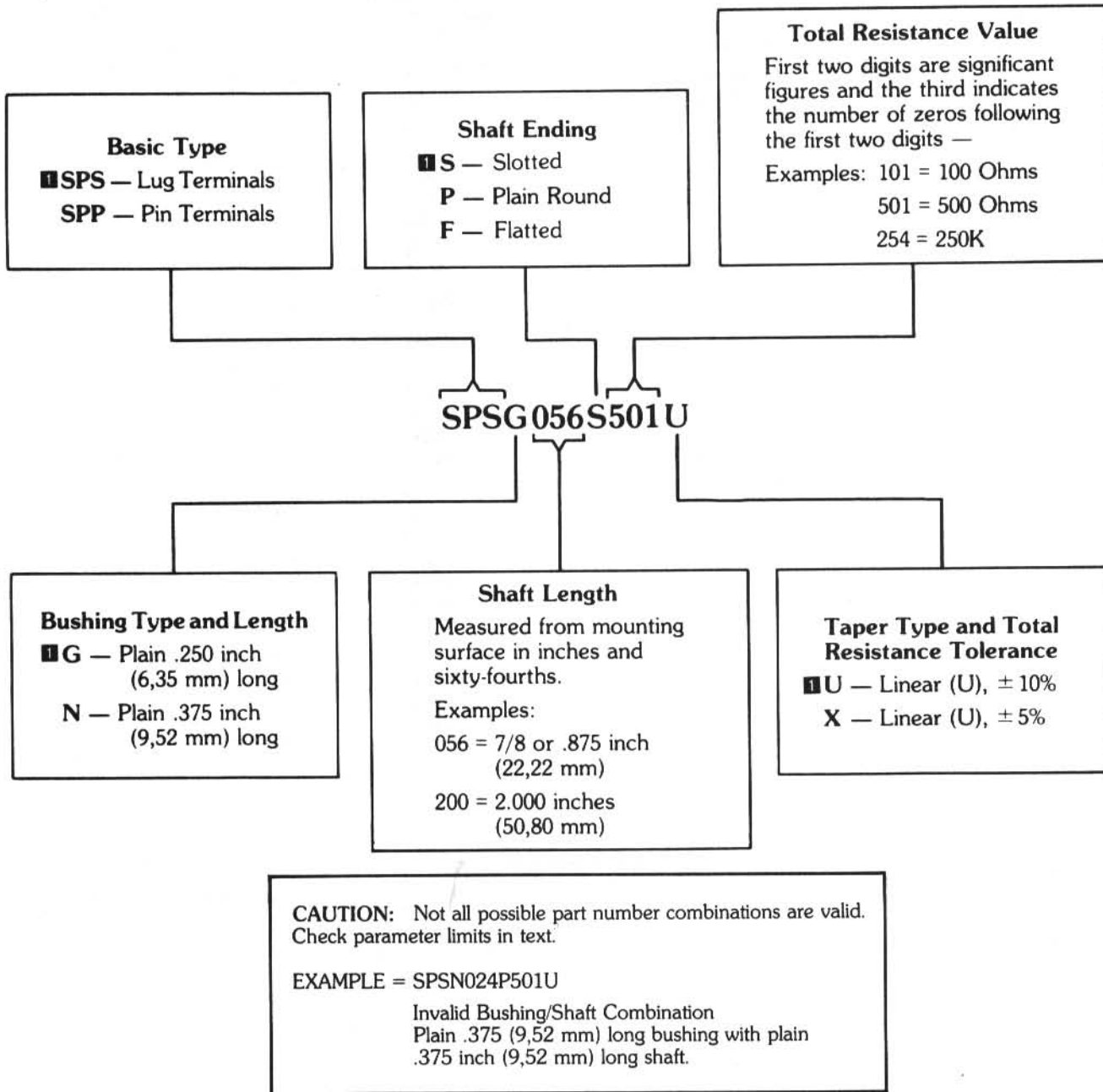

■ THESE CONFIGURATIONS ARE AVAILABLE AS A SPECIAL ORDER ONLY.

## Available Catalog Order Number Values

Basic Type	SPS	
Bushing Length, Inches	1/4	
Bushing Type	Plain	
Shaft Length, Inches Plain Ending	5/8	
Resistance (ohms)	Code	"U" Taper Only
		SPSG 040S
100	101	—
1000	102	—
10000	103	—
100000	104	—
1000000	105	—
250	251	—
2500	252	—
25000	253	—
250000	254	—
50	500	—
500	501	—
5000	502	—
50000	503	—
500000	504	—

— = Available as a Special Order only. Contact factory for information.

## Available Special Order Number Values

Type SP

Basic Type	SPS, SPP		
Bushing Length, Inches	1/4, 3/8		
Bushing Type	Plain		
Shaft Length, Inches Plain Ending or Slotted Ending	5/16, 3/8, 7/16, 1/2, 5/8, 3/4, 7/8		
Resistance (ohms)	Code	Taper	
		"U"	"X"
100	101	—	—
1000	102	—	—
10000	103	—	—
100000	104	—	—
1000000	105	—	—
200	201	—	—
2000	202	—	—
20000	203	—	—
200000	204	—	—
2000000	205	*	*
250	251	—	—
2500	252	—	—
25000	253	—	—
250000	254	—	—
2500000	255	*	*
50	500	—	—
500	501	—	—
5000	502	—	—
50000	503	—	—
500000	504	—	—
5000000	505	*	*
750	751	—	—
7500	752	—	—
75000	753	—	—
750000	754	—	—
7500000	755	*	*

— = Available as a Special Order only. Contact factory for information.  
\* = Not Available.

## Ordering Information

1. Type (SPS, or SPP).
2. Taper (U, X).
3. Total resistance value in ohms.
4. Bushing type.
5. Bushing length in inches.
6. Shaft ending (plain, slotted or flatted).
7. Shaft length from mounting surface in inches.
8. Locating lug option (1,2,3,4,5,6 or 7).
9. Mounting hardware (A-B Standard or Other).
10. Part number you have assigned, if any.
11. Marking required on the part.
12. Special features.\*

\*Forward complete detailed specifications to the factory.

## DIMENSIONS

### Type SPS Plain Bushing – Solder Terminals

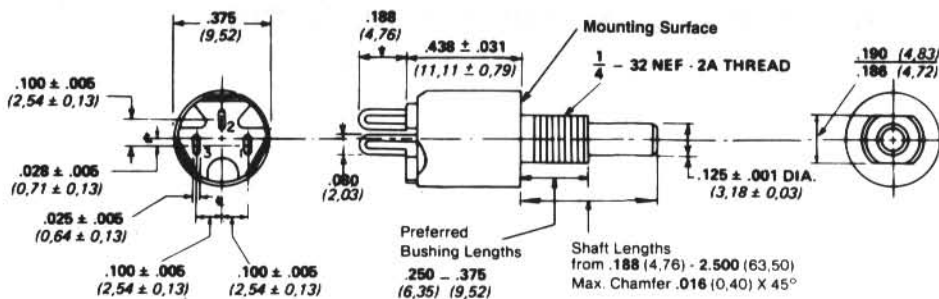

### Resistor Connections

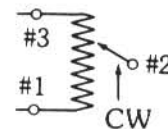

# DIMENSIONS

## Type SPP Plain Bushing

## Pin Terminals

## Hardware

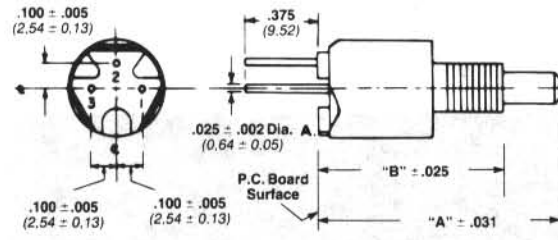

Shaft Length	"A"
.500 (12,70)	.938 (23,82)
.750 (19,05)	1.188 (30,17)

Bushing Length	"B"
.250 (6,35)	.688 (17,47)
.375 (9,53)	.813 (20,65)

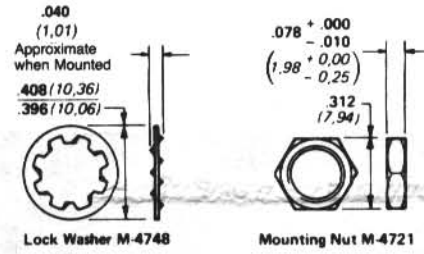

## Shaft Endings

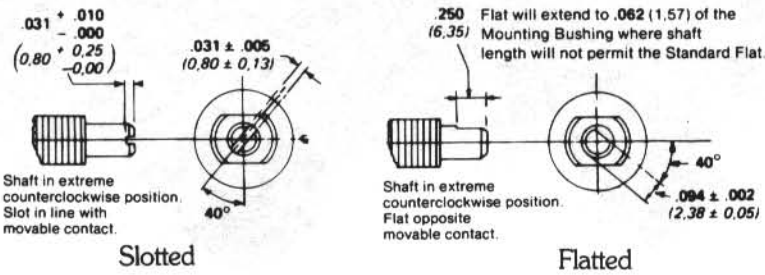

Basic dimensions in inches.  
 Dimensions shown in parentheses are in millimeters.  
**TOLERANCES**  
 Dimensional tolerance ± .016 (0,40)  
 Angular tolerance ± 5° Except as specified.  
**NOT TO SCALE**

## Locating Lug Options

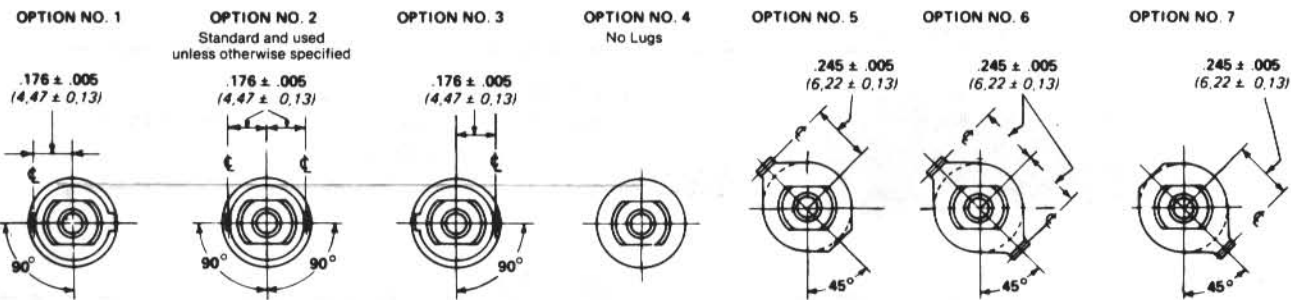

## Adapter Plates

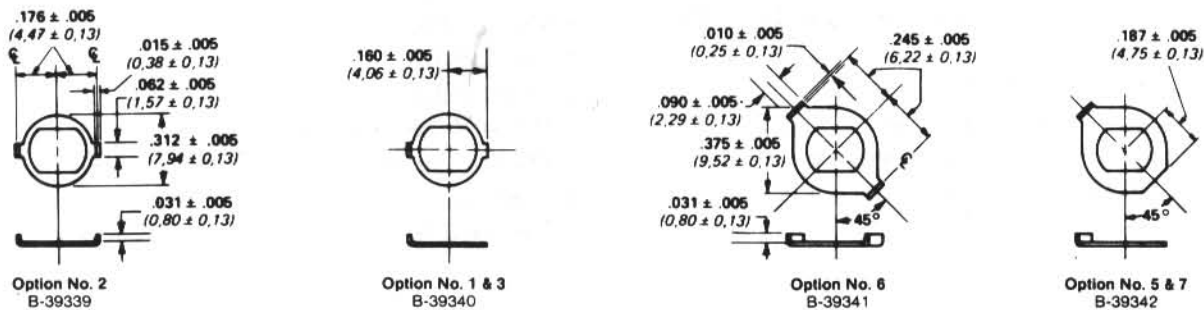

## Mounting Holes

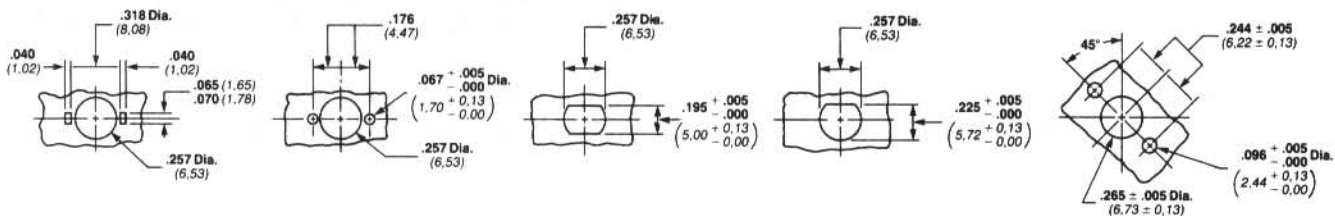





## Looking for pricing, stock, or lifecycle information?

Click below to explore more details on WIN SOURCE:

 [View SPSG040F103X on WIN SOURCE](#)

 [Honeywell Information](#)

## Optimize Your Supply Chain with WIN SOURCE Solutions

-  Global Sourcing Solution
-  Obsolete Management
-  Cost Control Management
-  Shortage Management
-  Alternative Solution
-  Excess Inventory Management