



**THE DATASHEET OF  
CY2305SXC-1H**



## Features

- 10 MHz to 100/133 MHz operating range, compatible with CPU and PCI bus frequencies
- Zero input-output propagation delay
- 60-ps typical cycle-to-cycle jitter (high drive)
- Multiple low skew outputs
  - 85 ps typical output-to-output skew
  - One input drives five outputs (CY2305)
  - One input drives nine outputs, grouped as 4 + 4 + 1 (CY2309)
- Compatible with Pentium-based systems
- Test Mode to bypass phase-locked loop (PLL) (CY2309)
- Packages:
  - 8-pin, 150-mil SOIC package (CY2305)
  - 16-pin 150-mil SOIC or 4.4-mm TSSOP (CY2309)
- 3.3 V operation
- Commercial and industrial temperature ranges

## Functional Description

The CY2309 is a low-cost 3.3 V zero delay buffer designed to distribute high speed clocks and is available in a 16-pin SOIC or TSSOP package. The CY2305 is an 8-pin version of the CY2309. It accepts one reference input, and drives out five low skew clocks. The -1H versions of each device operate at up to 100-/133 MHz frequencies, and have higher drive than the -1 devices. All parts have on-chip PLLs which lock to an input clock on the REF pin. The PLL feedback is on-chip and is obtained from the CLKOUT pad.

The CY2309 has two banks of four outputs each, which can be controlled by the select inputs as shown in [Select Input Decoding](#) on page 5. If all output clocks are not required, BankB can be three-stated. The select inputs also allow the input clock to be directly applied to the outputs for chip and system testing purposes.

The CY2305 and CY2309 PLLs enter a power-down mode when there are no rising edges on the REF input. In this state, the outputs are three-stated and the PLL is turned off, resulting in less than 25.0  $\mu$ A current draw for these parts. The CY2309 PLL shuts down in one additional case as shown in [Select Input Decoding](#) on page 5.

Multiple CY2305 and CY2309 devices can accept the same input clock and distribute it. In this case, the skew between the outputs of two devices is guaranteed to be less than 700 ps.

The CY2305/CY2309 is available in two or three different configurations, as shown in [Ordering Information](#) on page 16. The CY2305-1/CY2309-1 is the base part. The CY2305-1H/CY2309-1H is the high-drive version of the -1, and its rise and fall times are much faster than the -1.

For a complete list of related documentation, click [here](#).

## Logic Block Diagram

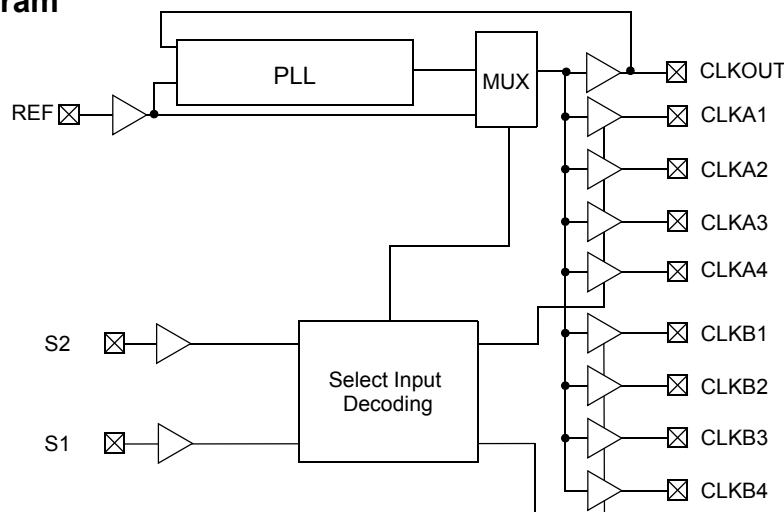

## Contents

Pin Diagram .....	3	Ordering Information .....	16
Pin Description .....	3	Ordering Information .....	16
Pin Diagram .....	4	Ordering Code Definitions .....	17
Pin Description .....	4	<b>Package Drawing and Dimensions .....</b>	<b>18</b>
Select Input Decoding .....	5	<b>Acronyms .....</b>	<b>20</b>
Zero Delay and Skew Control .....	5	<b>Document Conventions .....</b>	<b>20</b>
Absolute Maximum Conditions .....	6	Units of Measure .....	20
Operating Conditions .....	6	<b>Errata .....</b>	<b>21</b>
Electrical Characteristics .....	6	Part Numbers Affected .....	21
Operating Conditions .....	7	CY2305/CY2309 Errata Summary .....	22
Electrical Characteristics .....	7	CY2305/CY2309 Qualification Status .....	22
Test Circuits .....	8	<b>Document History Page .....</b>	<b>23</b>
Thermal Resistance .....	8	<b>Sales, Solutions, and Legal Information .....</b>	<b>25</b>
Typical Duty Cycle and I <sub>DD</sub> Trends .....	9	Worldwide Sales and Design Support .....	25
Typical Duty Cycle and I <sub>DD</sub> Trends .....	10	Products .....	25
Switching Characteristics .....	11	PSoC@Solutions .....	25
Switching Characteristics .....	12	Cypress Developer Community .....	25
Switching Characteristics .....	13	Technical Support .....	25
Switching Characteristics .....	14		
Switching Waveforms .....	15		

## Pin Diagram

Figure 1. 8-pin SOIC pinout  
CY2305

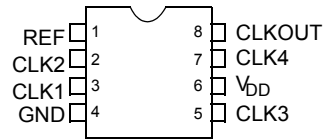

## Pin Description

For CY2305

Pin	Signal	Description
1	REF <sup>[1]</sup>	Input reference frequency, 5-V tolerant input
2	CLK2 <sup>[2]</sup>	Buffered clock output
3	CLK1 <sup>[2]</sup>	Buffered clock output
4	GND	Ground
5	CLK3 <sup>[2]</sup>	Buffered clock output
6	V <sub>DD</sub>	3.3-V supply
7	CLK4 <sup>[2]</sup>	Buffered clock output
8	CLKOUT <sup>[2]</sup>	Buffered clock output, internal feedback on this pin

### Notes

1. Weak pull down.
2. Weak pull down on all outputs.

## Pin Diagram

**Figure 2. 16-pin SOIC / TSSOP pinout  
CY2309**

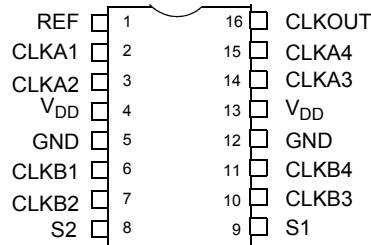

## Pin Description

For CY2309

Pin	Signal	Description
1	REF <sup>[3]</sup>	Input reference frequency, 5-V tolerant input
2	CLKA1 <sup>[4]</sup>	Buffered clock output, Bank A
3	CLKA2 <sup>[4]</sup>	Buffered clock output, Bank A
4	V <sub>DD</sub>	3.3-V supply
5	GND	Ground
6	CLKB1 <sup>[4]</sup>	Buffered clock output, Bank B
7	CLKB2 <sup>[4]</sup>	Buffered clock output, Bank B
8	S2 <sup>[5]</sup>	Select input, bit 2
9	S1 <sup>[5]</sup>	Select input, bit 1
10	CLKB3 <sup>[4]</sup>	Buffered clock output, Bank B
11	CLKB4 <sup>[4]</sup>	Buffered clock output, Bank B
12	GND	Ground
13	V <sub>DD</sub>	3.3-V supply
14	CLKA3 <sup>[4]</sup>	Buffered clock output, Bank A
15	CLKA4 <sup>[4]</sup>	Buffered clock output, Bank A
16	CLKOUT <sup>[4]</sup>	Buffered output, internal feedback on this pin

### Notes

3. Weak pull down.
4. Weak pull down on all outputs.
5. Weak pull ups on these inputs.

## Select Input Decoding

For CY2309

S2	S1	CLOCK A1–A4	CLOCK B1–B4	CLKOUT <sup>[6]</sup>	Output Source	PLL Shutdown
0	0	Three-state	Three-state	Driven	PLL	N
0	1	Driven	Three-state	Driven	PLL	N
1	0	Driven	Driven	Driven	Reference	Y
1	1	Driven	Driven	Driven	PLL	N

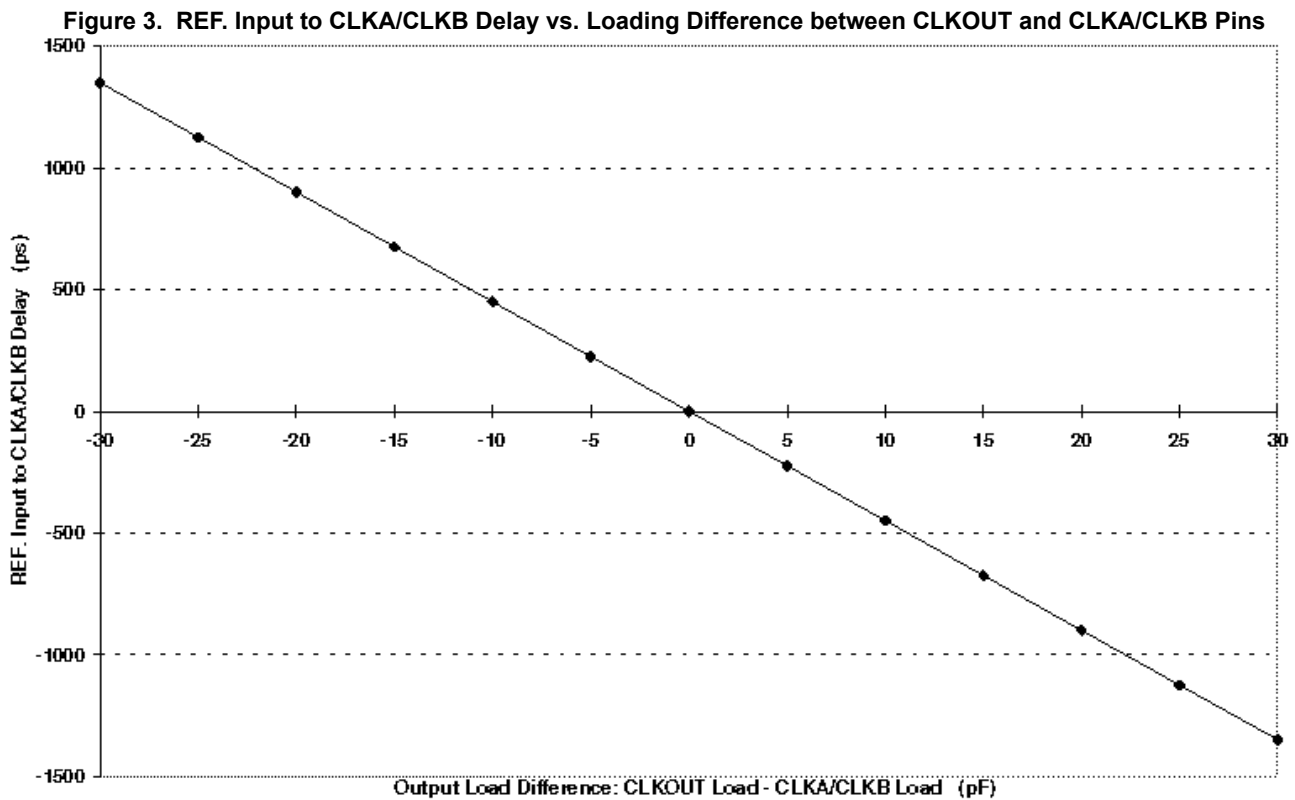

## Zero Delay and Skew Control

All outputs must be uniformly loaded to achieve zero delay between the input and output. Because the CLKOUT pin is the internal feedback to the PLL, its relative loading can adjust the input-output delay. This is shown in the above graph.

For applications requiring zero input-output delay, all outputs, including CLKOUT, must be equally loaded. Even if CLKOUT is not used, it must have a capacitive load, equal to that on other outputs, for obtaining zero input-output delay. If input to output delay adjustments are required, use [Figure 3](#) to calculate loading differences between the CLKOUT pin and other outputs.

### Note

- This output is driven and has an internal feedback for the PLL. The load on this output can be adjusted to change the skew between the reference and output.

## Absolute Maximum Conditions

Supply voltage to ground potential .....-0.5 V to +7.0 V  
 DC input voltage (Except REF) .....-0.5 V to  $V_{DD} + 0.5$  V  
 DC input voltage REF .....-0.5 V to 7 V

Storage temperature ..... -65°C to +150°C  
 Junction temperature ..... 150°C  
 Static discharge voltage  
 (per MIL-STD-883, Method 3015) ..... > 2,000 V

## Operating Conditions

For CY2305SC-XX and CY2309SC-XX Commercial Temperature Devices

Parameter	Description	Min	Max	Unit
$V_{DD}$	Supply voltage	3.0	3.6	V
$T_A$	Operating temperature (ambient temperature)	0	70	°C
$C_L$	Load capacitance, below 100 MHz	–	30	pF
$C_L$	Load capacitance, from 100 MHz to 133 MHz	–	10	pF
$C_{IN}$	Input capacitance	–	7	pF
$t_{PU}$	Power-up time for all $V_{DD}$ s to reach minimum specified voltage (power ramps must be monotonic)	0.05	50	ms

## Electrical Characteristics

For CY2305SC-XX and CY2309SC-XX Commercial Temperature Devices

Parameter	Description	Test Conditions	Min	Max	Unit
$V_{IL}$	Input LOW voltage <sup>[7]</sup>		–	0.8	V
$V_{IH}$	Input HIGH voltage <sup>[7]</sup>		2.0	–	V
$I_{IL}$	Input LOW current	$V_{IN} = 0$ V	–	50.0	μA
$I_{IH}$	Input HIGH current	$V_{IN} = V_{DD}$	–	100.0	μA
$V_{OL}$	Output LOW voltage <sup>[8]</sup>	$I_{OL} = 8$ mA (-1)	–	0.4	V
		$I_{OL} = 12$ mA (-1H)			
$V_{OH}$	Output HIGH voltage <sup>[8]</sup>	$I_{OH} = -8$ mA (-1)	2.4	–	V
		$I_{OH} = -12$ mA (-1H)			
$I_{DD}$ (PD mode)	Power-down supply current	REF = 0 MHz	–	12.0	μA
$I_{DD}$	Supply current	Unloaded outputs at 66.67 MHz, SEL inputs at $V_{SS}$	–	32.0	mA

### Notes

7. REF input has a threshold voltage of  $V_{DD}/2$ .
8. Parameter is guaranteed by design and characterization. Not 100% tested in production.

## Operating Conditions

For CY2305SI-XX and CY2309SI-XX Industrial Temperature Devices

Parameter	Description	Min	Max	Unit
V <sub>DD</sub>	Supply voltage	3.0	3.6	V
T <sub>A</sub>	Operating temperature (ambient temperature)	-40	85	°C
C <sub>L</sub>	Load capacitance, below 100 MHz	-	30	pF
C <sub>L</sub>	Load capacitance, from 100 MHz to 133 MHz	-	10	pF
C <sub>IN</sub>	Input capacitance	-	7	pF
t <sub>PU</sub>	Power-up time for all V <sub>DD</sub> s to reach minimum specified voltage (power ramps must be monotonic)	0.05	50	ms

## Electrical Characteristics

For CY2305SI-XX and CY2309SI-XX Industrial Temperature Devices

Parameter	Description	Test Conditions	Min	Max	Unit
V <sub>IL</sub>	Input LOW voltage <sup>[9]</sup>		-	0.8	V
V <sub>IH</sub>	Input HIGH voltage <sup>[9]</sup>		2.0	-	V
I <sub>IL</sub>	Input LOW current	V <sub>IN</sub> = 0 V	-	50.0	μA
I <sub>IH</sub>	Input HIGH current	V <sub>IN</sub> = V <sub>DD</sub>	-	100.0	μA
V <sub>OL</sub>	Output LOW voltage <sup>[10]</sup>	I <sub>OL</sub> = 8 mA (-1)	-	0.4	V
		I <sub>OL</sub> = 12 mA (-1H)			
V <sub>OH</sub>	Output HIGH voltage <sup>[10]</sup>	I <sub>OH</sub> = -8 mA (-1)	2.4	-	V
		I <sub>OH</sub> = -12 mA (-1H)			
I <sub>DD</sub> (PD mode)	Power-down supply current	REF = 0 MHz	-	25.0	μA
I <sub>DD</sub>	Supply current	Unloaded outputs at 66.67 MHz, SEL inputs at V <sub>SS</sub>	-	35.0	mA

### Notes

9. REF input has a threshold voltage of V<sub>DD</sub>/2.

10. Parameter is guaranteed by design and characterization. Not 100% tested in production.

## Test Circuits

Figure 4. Test Circuits

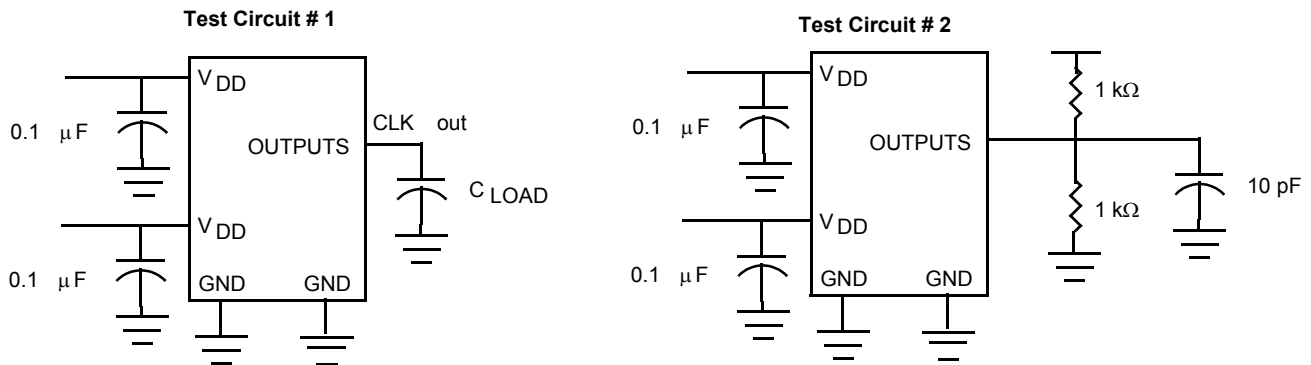

For parameter  $t_b$  (output slew rate) on -1H devices

## Thermal Resistance

Parameter <sup>[11]</sup>	Description	Test Conditions	8-pin SOIC	16-pin SOIC	16-pin TSSOP	Unit
$\theta_{JA}$	Thermal resistance (junction to ambient)	Test conditions follow standard test methods and procedures for measuring thermal impedance, in accordance with EIA/JESD51.	140	111	117	°C/W
$\theta_{JC}$	Thermal resistance (junction to case)		54	60	22	°C/W

**Note**

11. These parameters are guaranteed by design and are not tested.

## Typical Duty Cycle and I<sub>DD</sub> Trends

For CY2305-1 and CY2309-1 [12, 13]

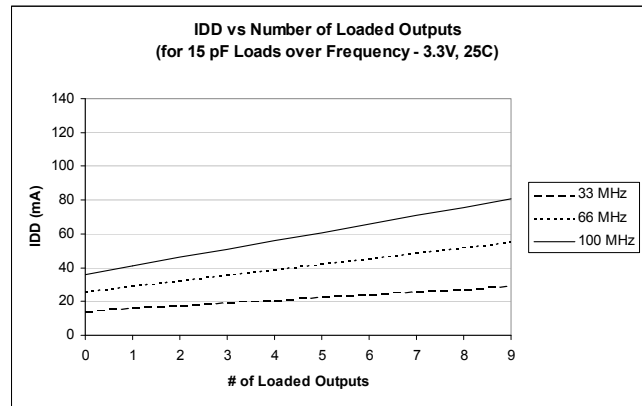
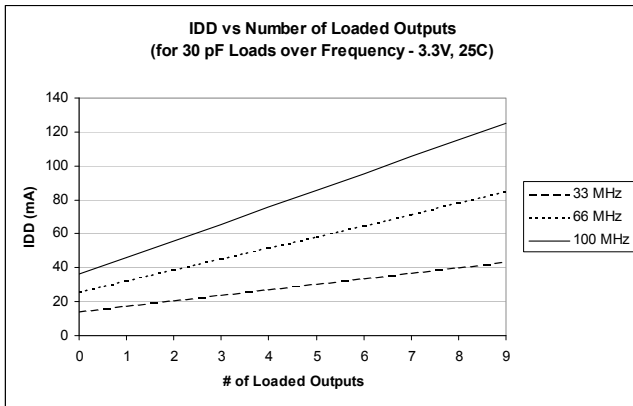
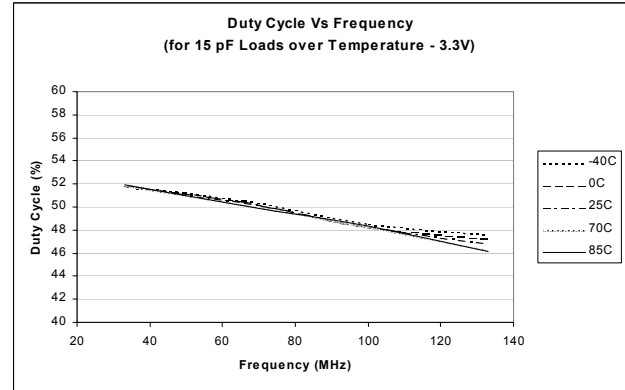
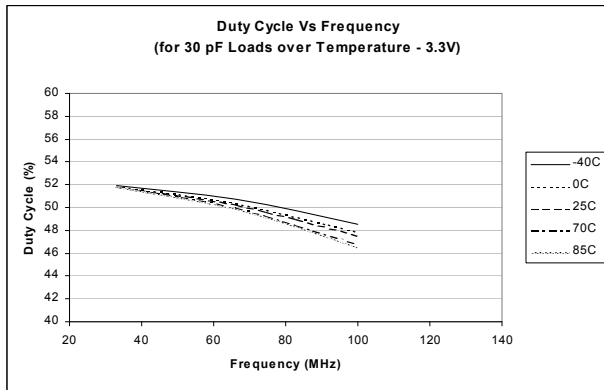
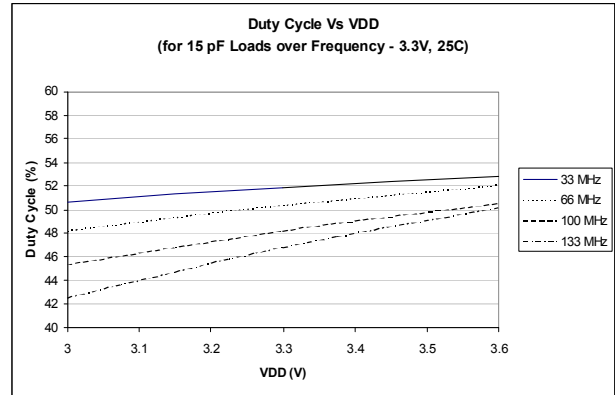
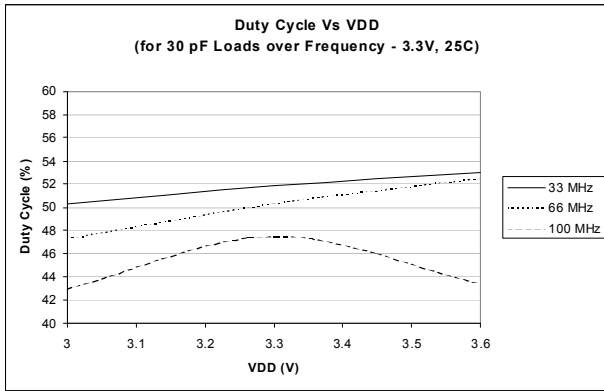

### Notes

12. Duty cycle is taken from typical chip measured at 1.4 V.

13. I<sub>DD</sub> data is calculated from  $I_{DD} = I_{CORE} + nCVf$ , where  $I_{CORE}$  is the unloaded current. ( $n$  = # of outputs;  $C$  = Capacitance load per output (F);  $V$  = Supply Voltage (V);  $f$  = frequency (Hz)).

## Typical Duty Cycle and $I_{DD}$ Trends

For CY2305-1H and CY2309-1H [14, 15]

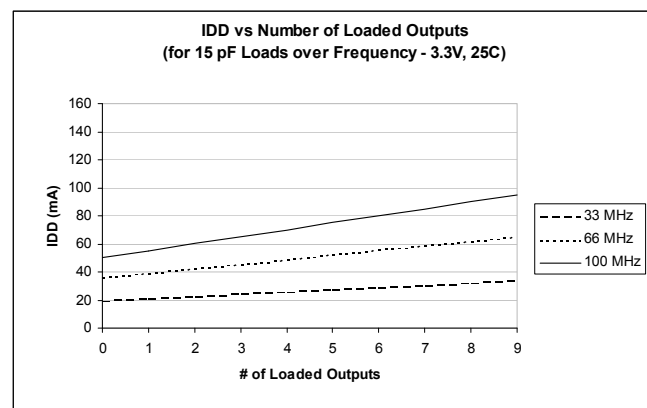
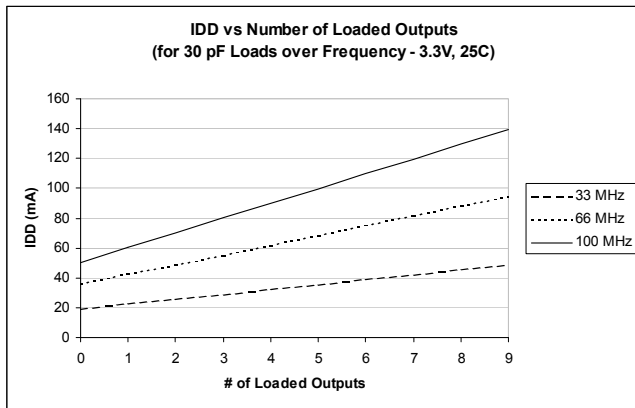
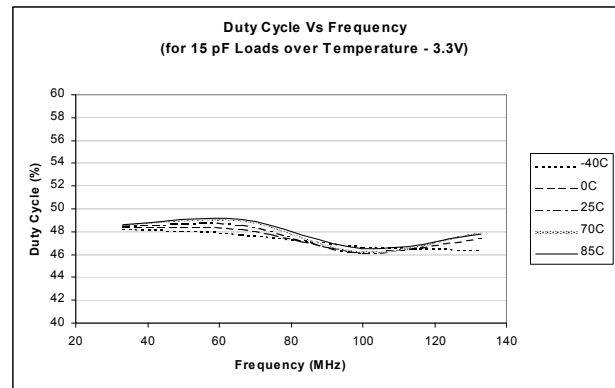
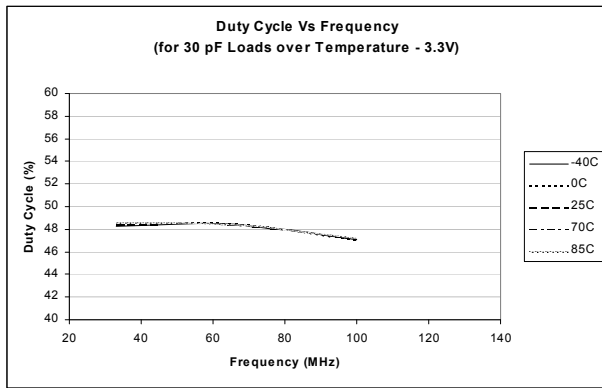
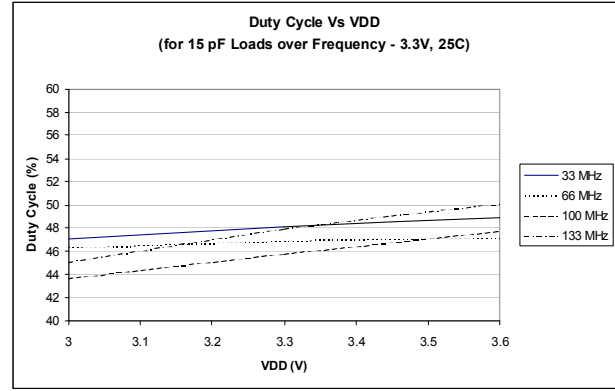
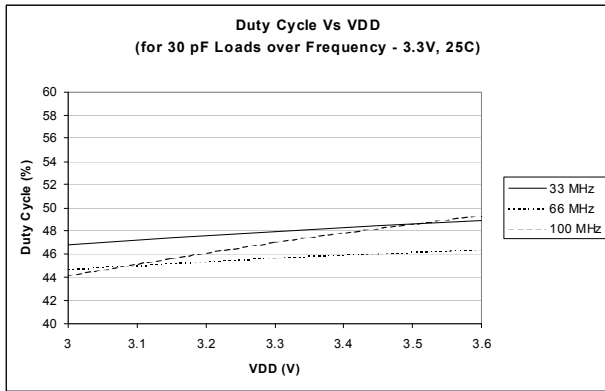

### Notes

14. Duty cycle is taken from typical chip measured at 1.4 V.

15.  $I_{DD}$  data is calculated from  $I_{DD} = I_{CORE} + nCVf$ , where  $I_{CORE}$  is the unloaded current. ( $n$  = # of outputs;  $C$  = Capacitance load per output (F);  $V$  = Supply Voltage (V);  $f$  = frequency (Hz)).

## Switching Characteristics

For CY2305SC-1 and CY2309SC-1 Commercial Temperature Devices

Parameter <sup>[16]</sup>	Description	Test Conditions	Min	Typ	Max	Unit
t <sub>1</sub>	Output frequency	30-pF load	10	–	100	MHz
		10-pF load	10	–	133.33	MHz
t <sub>DC</sub>	Duty cycle <sup>[17]</sup> = t <sub>2</sub> ÷ t <sub>1</sub>	Measured at 1.4 V, F <sub>out</sub> = 66.67 MHz	40.0	50.0	60.0	%
t <sub>3</sub>	Rise time <sup>[17]</sup>	Measured between 0.8 V and 2.0 V	–	–	2.50	ns
t <sub>4</sub>	Fall time <sup>[17]</sup>	Measured between 0.8 V and 2.0 V	–	–	2.50	ns
t <sub>5</sub>	Output-to-output skew <sup>[17]</sup>	All outputs equally loaded	–	85	250	ps
t <sub>6A</sub>	Delay, REF rising edge to CLKOUT rising edge <sup>[17]</sup>	Measured at V <sub>DD</sub> /2	–	0	±350	ps
t <sub>6B</sub>	Delay, REF rising edge to CLKOUT rising edge <sup>[17]</sup>	Measured at V <sub>DD</sub> /2. Measured in PLL Bypass Mode, CY2309 device only.	1	5	8.7	ns
t <sub>7</sub>	Device-to-device skew <sup>[17]</sup>	Measured at V <sub>DD</sub> /2 on the CLKOUT pins of devices	–	–	700	ps
t <sub>J</sub>	Cycle-to-cycle jitter <sup>[17]</sup>	Measured at 66.67 MHz, loaded outputs	–	70	200	ps
t <sub>LOCK</sub>	PLL lock time <sup>[17, 18, 19]</sup>	Stable power supply, valid clock presented on REF pin	–	–	1.0	ms

### Notes

16. All parameters specified with loaded outputs.

17. Parameter is guaranteed by design and characterization. Not 100% tested in production.

18. The clock outputs are undefined until PLL is locked.

19. For on the fly change in reference input frequency, PLL lock time is only guaranteed when stop time between change in input reference frequency is > 10 μs, [Figure 10](#).

## Switching Characteristics

For CY2305SC-1H and CY2309SC-1H Commercial Temperature Devices

Parameter <sup>[20]</sup>	Description	Condition	Min	Typ	Max	Unit
t <sub>1</sub>	Output frequency	30 pF load	10	–	100	MHz
		10 pF load	10	–	133.33	MHz
t <sub>DC</sub>	Duty cycle <sup>[21]</sup> = t <sub>2</sub> ÷ t <sub>1</sub>	Measured at 1.4 V, F <sub>out</sub> = 66.67 MHz	40.0	50.0	60.0	%
t <sub>DC</sub>	Duty cycle <sup>[21]</sup> = t <sub>2</sub> ÷ t <sub>1</sub>	Measured at 1.4 V, F <sub>out</sub> < 50 MHz	45.0	50.0	55.0	%
t <sub>3</sub>	Rise time <sup>[21]</sup>	Measured between 0.8 V and 2.0 V	–	–	1.50	ns
t <sub>4</sub>	Fall time <sup>[21]</sup>	Measured between 0.8 V and 2.0 V	–	–	1.50	ns
t <sub>5</sub>	Output-to-output skew <sup>[21]</sup>	All outputs equally loaded	–	85	250	ps
t <sub>6A</sub>	Delay, REF rising edge to CLKOUT rising edge <sup>[21]</sup>	Measured at V <sub>DD</sub> /2	–	–	±350	ps
t <sub>6B</sub>	Delay, REF rising edge to CLKOUT rising edge <sup>[21]</sup>	Measured at V <sub>DD</sub> /2. Measured in PLL Bypass Mode, CY2309 device only.	1	5	8.7	ns
t <sub>7</sub>	Device-to-device skew <sup>[21]</sup>	Measured at V <sub>DD</sub> /2 on the CLKOUT pins of devices	–	–	700	ps
t <sub>8</sub>	Output slew rate <sup>[21]</sup>	Measured between 0.8 V and 2.0 V using Test Circuit #2	1	–		V/ns
t <sub>J</sub>	Cycle-to-cycle jitter <sup>[21]</sup>	Measured at 66.67 MHz, loaded outputs	–	60	200	ps
t <sub>LOCK</sub>	PLL lock time <sup>[21, 22, 23]</sup>	Stable power supply, valid clock presented on REF pin	–	–	1.0	ms

### Notes

20. All parameters specified with loaded outputs.

21. Parameter is guaranteed by design and characterization. Not 100% tested in production.

22. The clock outputs are undefined until PLL is locked.

23. For on the fly change in reference input frequency, PLL lock time is only guaranteed when stop time between change in input reference frequency is > 10 μs, [Figure 10](#).

## Switching Characteristics

For CY2305SI-1 and CY2309SI-1 Industrial Temperature Devices

Parameter <sup>[24]</sup>	Description	Test Conditions	Min	Typ	Max	Unit
t <sub>1</sub>	Output frequency	30 pF load	10	–	100	MHz
		10 pF load	10	–	133.33	MHz
t <sub>DC</sub>	Duty cycle <sup>[25]</sup> = $t_2 \div t_1$	Measured at 1.4 V, F <sub>out</sub> = 66.67 MHz	40.0	50.0	60.0	%
t <sub>3</sub>	Rise time <sup>[25]</sup>	Measured between 0.8 V and 2.0 V	–	–	2.50	ns
t <sub>4</sub>	Fall time <sup>[25]</sup>	Measured between 0.8 V and 2.0 V	–	–	2.50	ns
t <sub>5</sub>	Output-to-output skew <sup>[25]</sup>	All outputs equally loaded	–	85	250	ps
t <sub>6A</sub>	Delay, REF rising edge to CLKOUT rising edge <sup>[25]</sup>	Measured at V <sub>DD</sub> /2	–	–	±350	ps
t <sub>6B</sub>	Delay, REF rising edge to CLKOUT rising edge <sup>[25]</sup>	Measured at V <sub>DD</sub> /2. Measured in PLL Bypass Mode, CY2309 device only.	1	5	8.7	ns
t <sub>7</sub>	Device-to-device skew <sup>[25]</sup>	Measured at V <sub>DD</sub> /2 on the CLKOUT pins of devices	–	–	700	ps
t <sub>J</sub>	Cycle-to-cycle jitter <sup>[25]</sup>	Measured at 66.67 MHz, loaded outputs	–	70	200	ps
t <sub>LOCK</sub>	PLL lock time <sup>[25, 26, 27]</sup>	Stable power supply, valid clock presented on REF pin	–	–	1.0	ms

### Notes

24. All parameters specified with loaded outputs.

25. Parameter is guaranteed by design and characterization. Not 100% tested in production.

26. The clock outputs are undefined until PLL is locked.

27. For on the fly change in reference input frequency, PLL lock time is only guaranteed when stop time between change in input reference frequency is > 10 μs, [Figure 10](#).

## Switching Characteristics

For CY2305SI-1H and CY2309SI-1H Industrial Temperature Devices

Parameter <sup>[28]</sup>	Description	Conditions	Min	Typ	Max	Unit
t <sub>1</sub>	Output frequency	30 pF load	10	–	100	MHz
		10 pF load	10	–	133.33	MHz
t <sub>DC</sub>	Duty cycle <sup>[29]</sup> = t <sub>2</sub> ÷ t <sub>1</sub>	Measured at 1.4 V, F <sub>out</sub> = 66.67 MHz	40.0	50.0	60.0	%
t <sub>DC</sub>	Duty cycle <sup>[29]</sup> = t <sub>2</sub> ÷ t <sub>1</sub>	Measured at 1.4 V, F <sub>out</sub> < 50 MHz	45.0	50.0	55.0	%
t <sub>3</sub>	Rise time <sup>[29]</sup>	Measured between 0.8 V and 2.0 V	–	–	1.50	ns
t <sub>4</sub>	Fall time <sup>[29]</sup>	Measured between 0.8 V and 2.0 V	–	–	1.50	ns
t <sub>5</sub>	Output-to output skew <sup>[29]</sup>	All outputs equally loaded	–	85	250	ps
t <sub>6A</sub>	Delay, REF rising edge to CLKOUT rising edge <sup>[29]</sup>	Measured at V <sub>DD</sub> /2	–	–	±350	ps
t <sub>6B</sub>	Delay, REF rising edge to CLKOUT rising edge <sup>[29]</sup>	Measured at V <sub>DD</sub> /2. Measured in PLL Bypass Mode, CY2309 device only.	1	5	8.7	ns
t <sub>7</sub>	Device-to-device skew <sup>[29]</sup>	Measured at V <sub>DD</sub> /2 on the CLKOUT pins of devices	–	–	700	ps
t <sub>8</sub>	Output slew rate <sup>[29]</sup>	Measured between 0.8 V and 2.0 V using Test Circuit #2	1	–	–	V/ns
t <sub>J</sub>	Cycle-to-cycle jitter <sup>[29]</sup>	Measured at 66.67 MHz, loaded outputs	–	60	200	ps
t <sub>LOCK</sub>	PLL lock time <sup>[29, 30, 31]</sup>	Stable power supply, valid clock presented on REF pin	–	–	1.0	ms

### Notes

28. All parameters specified with loaded outputs.

29. Parameter is guaranteed by design and characterization. Not 100% tested in production.

30. The clock outputs are undefined until PLL is locked.

31. For on the fly change in reference input frequency, PLL lock time is only guaranteed when stop time between change in input reference frequency is > 10 μs, [Figure 10](#).

## Switching Waveforms

**Figure 5. Duty Cycle Timing**

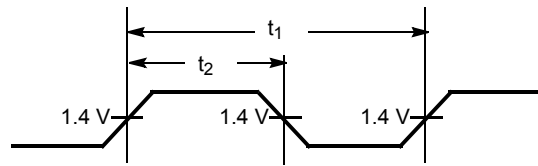

**Figure 6. All Outputs Rise/Fall Time**

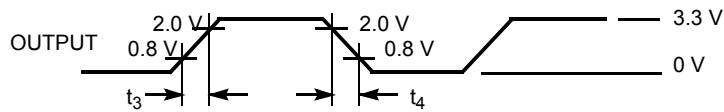

**Figure 7. Output-Output Skew**

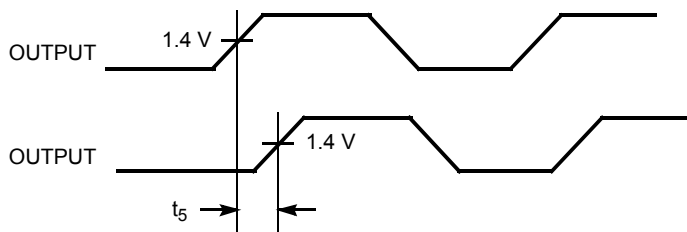

**Figure 8. Input-Output Propagation Delay**

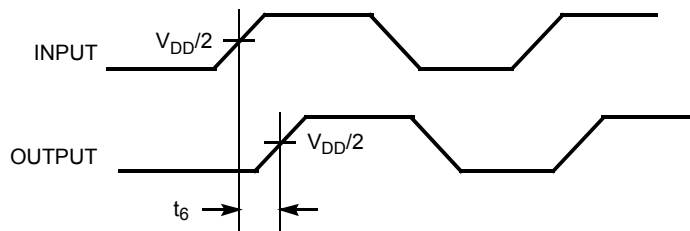

**Figure 9. Device-Device Skew**

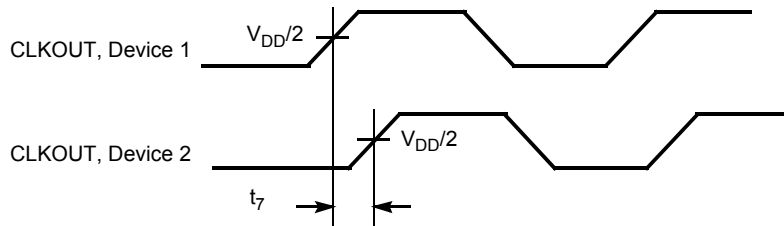

**Figure 10. Stop Time between Change in Input Reference Frequency**

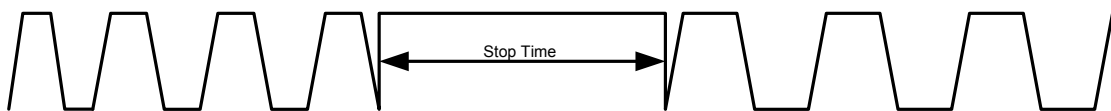

## Ordering Information

For CY2305

Ordering Code	Package Type	Operating Range
CY2305SC-1	8-pin SOIC (150 Mils)	Commercial
CY2305SC-1T	8-pin SOIC (150 Mils) – Tape and Reel	Commercial
<b>Pb-free</b>		
CY2305SXC-1	8-pin SOIC (150 Mils)	Commercial
CY2305SXC-1T	8-pin SOIC (150 Mils) – Tape and Reel	Commercial
CY2305SXI-1	8-pin SOIC (150 Mils)	Industrial
CY2305SXI-1T	8-pin SOIC (150 Mils) – Tape and Reel	Industrial
CY2305SXC-1H	8-pin SOIC (150 Mils)	Commercial
CY2305SXC-1HT	8-pin SOIC (150 Mils) – Tape and Reel	Commercial
CY2305SXI-1H	8-pin SOIC (150 Mils)	Industrial
CY2305SXI-1HT	8-pin SOIC (150 Mils) – Tape and Reel	Industrial

## Ordering Information

For CY2309

Ordering Code	Package Type	Operating Range
<b>Pb-free</b>		
CY2309SXC-1	16-pin SOIC (150 Mils)	Commercial
CY2309SXC-1T	16-pin SOIC (150 Mils) – Tape and Reel	Commercial
CY2309SXI-1	16-pin SOIC (150 Mils)	Industrial
CY2309SXI-1T	16-pin SOIC (150 Mils) – Tape and Reel	Industrial
CY2309SXC-1H	16-pin SOIC (150 Mils)	Commercial
CY2309SXC-1HT	16-pin SOIC (150 Mils) – Tape and Reel	Commercial
CY2309SXI-1H	16-pin SOIC (150 Mils)	Industrial
CY2309SXI-1HT	16-pin SOIC (150 Mils) – Tape and Reel	Industrial
CY2309ZXC-1H	16-pin TSSOP (4.4 mm)	Commercial
CY2309ZXC-1HT	16-pin TSSOP (4.4 mm) – Tape and Reel	Commercial
CY2309ZXI-1H	16-pin TSSOP (4.4 mm)	Industrial
CY2309ZXI-1HT	16-pin TSSOP (4.4 mm) – Tape and Reel	Industrial

**Ordering Code Definitions**

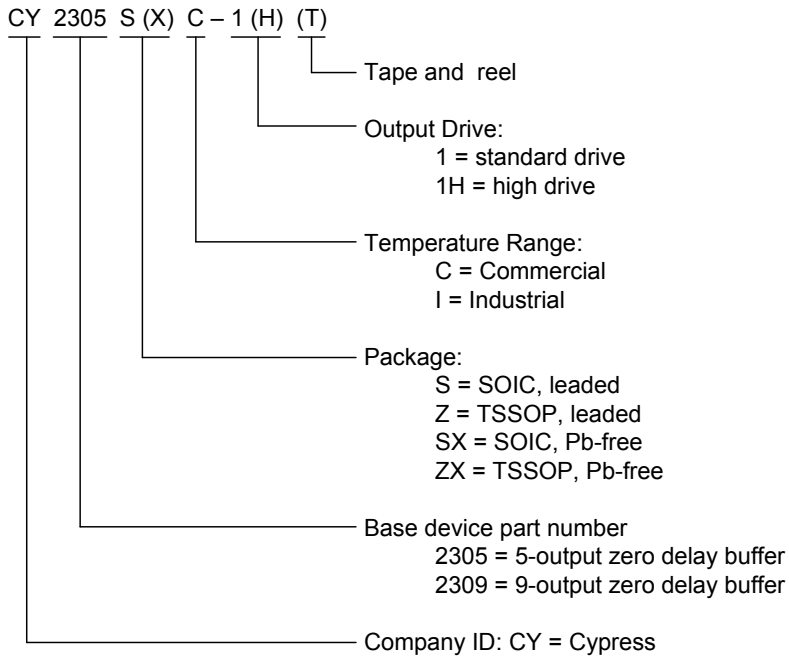

### Package Drawing and Dimensions

Figure 11. 8-pin SOIC (150 Mils) S0815/SZ815/SW815 Package Outline, 51-85066

1. DIMENSIONS IN INCHES[MM] MIN. MAX.
2. PIN 1 ID IS OPTIONAL.  
ROUND ON SINGLE LEADFRAME  
RECTANGULAR ON MATRIX LEADFRAME
3. REFERENCE JEDEC MS-012
4. PACKAGE WEIGHT 0.07gms

PART #	
S08.15	STANDARD PKG
SZ08.15	LEAD FREE PKG
SW8.15	LEAD FREE PKG

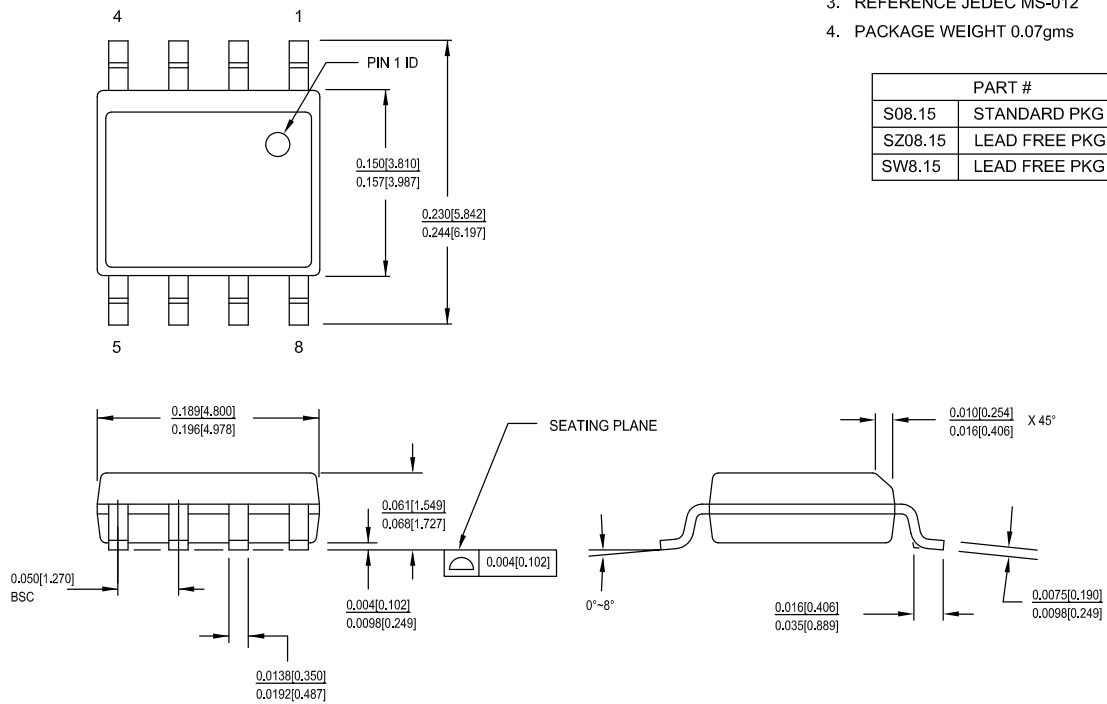

51-85066 \*H

Package Drawing and Dimensions (continued)

Figure 12. 16-pin SOIC (150 Mils) S16.15/SZ16.15 Package Outline, 51-85068

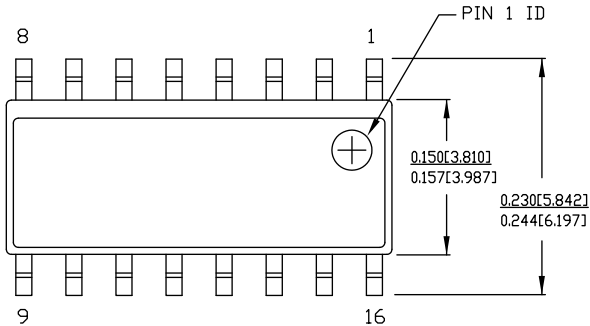

NOTE:

1. DIMENSIONS IN INCHES[MM] MAX.
2. REFERENCE JEDEC MS-012
3. PACKAGE WEIGHT : refer to PMDD spec. 001-04308

PART #	
S16.15	STANDARD PKG.
SZ16.15	LEAD FREE PKG.

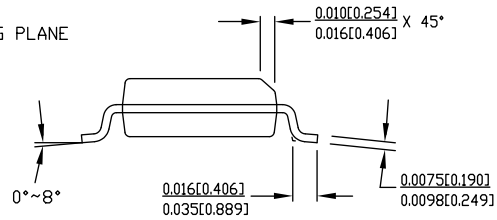
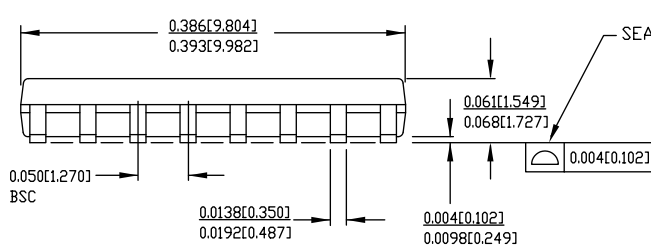

51-85068 \*E

Figure 13. 16-pin TSSOP (4.40 mm Body) Z16.173/ZZ16.173 Package Outline, 51-85091

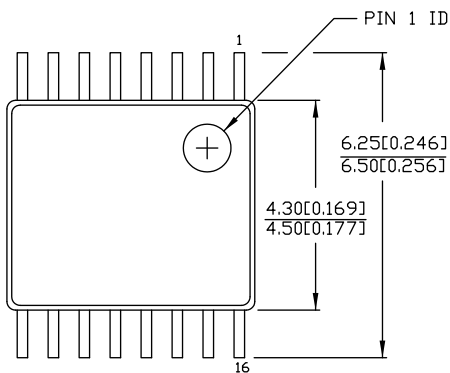

DIMENSIONS IN MM[INCHES] MIN.  
MAX.  
REFERENCE JEDEC MO-153  
PACKAGE WEIGHT 0.05gms

PART #	
Z16.173	STANDARD PKG.
ZZ16.173	LEAD FREE PKG.

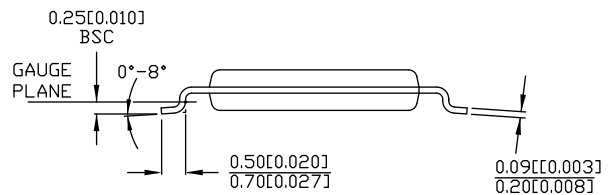
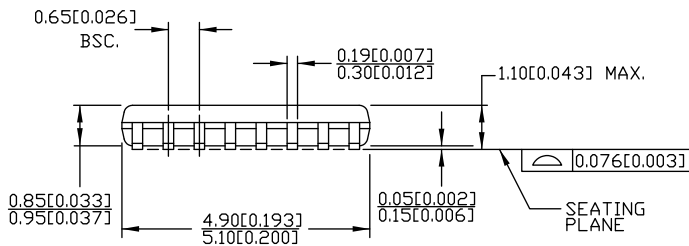

51-85091 \*E

## Acronyms

Acronym	Description
PCI	Personal Computer Interconnect
PLL	Phase Locked Loop
SDRAM	Synchronous Dynamic Random Access Memory
SOIC	Small Outline Integrated Circuit
TSSOP	Thin Small Outline Package
ZDB	Zero Delay Buffer

## Document Conventions

### Units of Measure

Symbol	Unit of Measure
°C	degree Celsius
μA	microampere
mA	milliampere
ms	millisecond
MHz	megahertz
ns	nanosecond
pF	picofarad
ps	picosecond
V	volt

## Errata

This section describes the errata for Cypress Zero Delay Clock Buffers of the family CY2305/CY2309. Details include errata trigger conditions, scope of impact, available workaround, and silicon revision applicability.

Contact your local Cypress Sales Representative if you have questions.

### Part Numbers Affected

Part Number	Device Characteristics
CY2305SC-1	All Variants
CY2305SC-1T	All Variants
CY2305SC-1H	All Variants
CY2305SC-1HT	All Variants
CY2305SI-1H	All Variants
CY2305SI-1HT	All Variants
CY2305SXC-1	All Variants
CY2305SXC-1T	All Variants
CY2305SXI-1	All Variants
CY2305SXI-1H	All Variants
CY2305SXC-1HT	All Variants
CY2305SXI-1H	All Variants
CY2305SXI-1HT	All Variants
CY2309NZSXC-1H	All Variants
CY2309NZSXC-1HT	All Variants
CY2309NZSXI-1H	All Variants
CY2309NZSXI-1HT	All Variants
CY2309SC-1HT	All Variants
CY2309SXC-1H	All Variants
CY2309SXC-1HT	All Variants
CY2309SXI-1H	All Variants
CY2309SXI-1HT	All Variants
CY2309ZC-1H	All Variants
CY2309ZC-1HT	All Variants
CY2309ZXC-1H	All Variants
CY2309ZXC-1HT	All Variants
CY2309ZXI-1H	All Variants
CY2309ZXI-1HT	All Variants
CY2309SXC-1	All Variants
CY2309SXC-1T	All Variants
CY2309SXI-1	All Variants
CY2309SXI-1T	All Variants
CY2309SC-1	All Variants
CY2309SC-1T	All Variants
CY2309SXC-1	All Variants
CY2309SXC-1T	All Variants
CY2309SXI-1	All Variants
CY2309SXI-1T	All Variants

**CY2305/CY2309 Errata Summary**

Items	Part Number	Silicon Revision	Fix Status
Start up lock time issue [CY2305]	All	B	Silicon fixed. New silicon available from WW 25 of 2011
Start up lock time issue [CY2309]	All	B	Silicon fixed. New silicon available from WW 10 of 2013

**CY2305/CY2309 Qualification Status**

Product Status: In production

Qualification report last updated on 11/27/2012 (<http://www.cypress.com/?riD=72595>)

**1. Start up lock time issue**

■ **Problem Definition**

Output of CY2305/CY2309 fails to locks within 1 ms (as per data sheet spec)

■ **Parameters Affected**

PLL lock time

■ **Trigger Condition(S)**

Start up

■ **Scope of Impact**

It can impact the performance of system and its throughput

■ **Workaround**

Apply reference input (RefClk) before power up (VDD) Input noise propagates to output due to absence of reference input signal during power up. If reference input is present during power up, the noise will not propagate to output and device will start normally without problems.

■ **Fix Status**

This issue is due to design marginality. Two minor design modifications have been made to address this problem.

- Addition of VCO bias detector block as shown in the following figure which keeps comparator power down till VCO bias is present and thereby eliminating the propagation of noise to feedback.
- Bias generator enhancement for successful initialization.

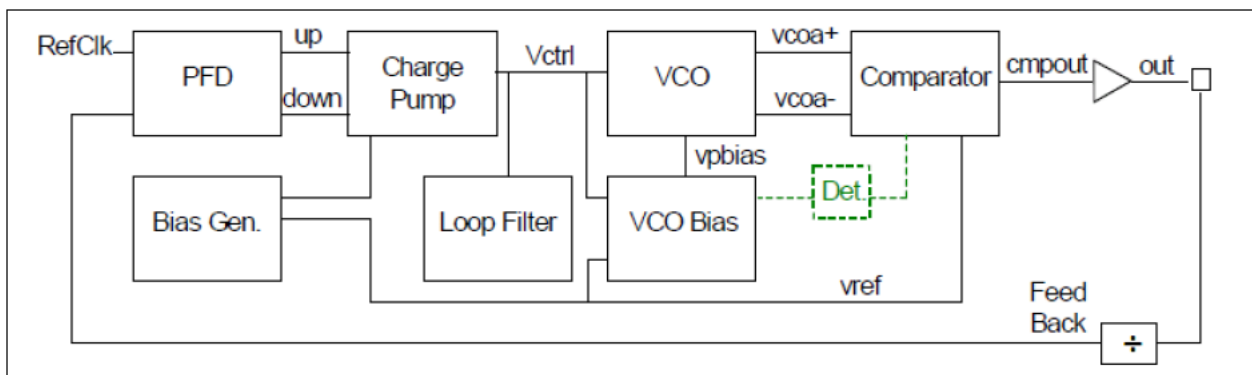

## Document History Page

Document Title: CY2305/CY2309, Low Cost 3.3 V Zero Delay Buffer				
Document Number: 38-07140				
Revision	ECN	Orig. of Change	Submission Date	Description of Change
**	110249	SZV	10/19/01	Change from Spec number: 38-00530 to 38-07140
*A	111117	CKN	03/01/02	Added t6B row to the Switching Characteristics Table; also added the letter "A" to the t6A row Corrected the table title from CY2305SC-IH and CY2309SC-IH to CY2305SI-IH and CY2309SI-IH
*B	117625	HWT	10/21/02	Added eight-pin TSSOP packages (CY2305ZC-1 and CY2305ZC-1T) to the ordering information table. Added the Tape and Reel option to all the existing packages: CY2305SC-1T, CY2305SI-1T, CY2305SC-1HT, CY2305SI-1HT, CY2305ZC-1T, CY2309SC-1T, CY2309SI-1T, CY2309SC-1HT, CY2309SI-1HT, CY2309ZC-1HT, CY2309ZI-1HT
*C	121828	RBI	12/14/02	Power up requirements added to Operating Conditions information
*D	131503	RGL	12/12/03	Added Lead-free for all the devices in the ordering information table
*E	214083	RGL	See ECN	Added a Lead-free with the new coding for all SOIC devices in the ordering information table
*F	291099	RGL	See ECN	Added TSSOP Lead-free devices
*G	390582	RGL	See ECN	Added typical values for jitter
*H	2542461	AESA	07/23/08	Updated template. Added Note "Not recommended for new designs." Added part number CY2305ESXC-1, CY2305ESXC-1T, CY2305ESXI-1, CY2305ESXI-1T, CY2305ESXC-1H, CY2305ESXC-1HT, CY2305ESXI-1H, CY2305ESXI-1HT, CY2309ESXC-1, CY2309ESXC-1T, CY2309ESXI-1, CY2309ESXI-1T, CY2309ESXC-1H, CY2309ESXC-1HT, CY2309ESXI-1H, CY2309ESXI-1HT, CY2309EZXC-1H, CY2309EZXC-1HT, CY2309EZXI-1H, and CY2309EZXI-1HT in ordering information table. Removed part number CY2305SZC-1, CY2305SZC-1T, CY2305SZI-1, CY2305SZI-1T, CY2305SZC-1H, CY2305SZC-1HT, CY2305SZI-1H, CY2305SZI-1HT, CY2309SZC-1, CY2309SZC-1T, CY2309SZI-1, CY2309SZI-1T, CY2309SZC-1H, CY2309SZC-1HT, CY2309SZI-1H, CY2309SZI-1HT, CY2309ZZC-1H, CY2309ZZC-1HT, CY2309ZI-1H, CY2309ZI-1HT, CY2309ZZI-1H, and CY2309ZZI-1HT in Ordering Information table. Changed Lead-Free to Pb-Free.
*I	2565153	AESA	09/18/08	Removed part number CY2305ESXC-1, CY2305ESXC-1T, CY2305ESXI-1, CY2305ESXI-1T, CY2305ESXC-1H, CY2305ESXC-1HT, CY2305ESXI-1H, CY2305ESXI-1HT, CY2309ESXC-1, CY2309ESXC-1T, CY2309ESXI-1, CY2309ESXI-1T, CY2309ESXC-1H, CY2309ESXC-1HT, CY2309ESXI-1H, CY2309ESXI-1HT, CY2309EZXC-1H, CY2309EZXC-1HT, CY2309EZXI-1H, and CY2309EZXI-1HT in ordering information table. Removed note references to note 10 in Pb-Free sections of ordering information table. Changed IDD (PD mode) from 12.0 to 25.0 $\mu$ A for commercial temperature devices Deleted Duty Cycle parameters for $F_{out} < 50$ MHz commercial and industrial devices.
*J	2673353	KVM / PYRS	03/13/09	Reverted IDD (PD mode) and Duty Cycle parameters back to the values in revision *H: Changed IDD (PD mode) from 25 to 12 $\mu$ A for commercial devices. Added Duty Cycle parameters for $F_{out} < 50$ MHz for commercial and industrial devices.

**Document History Page** (continued)

Document Title: CY2305/CY2309, Low Cost 3.3 V Zero Delay Buffer				
Document Number: 38-07140				
Revision	ECN	Orig. of Change	Submission Date	Description of Change
*K	2904641	KVM	04/05/10	Updated <a href="#">Ordering Information</a> : Removed parts CY2305SI-1, CY2305SI-1T, CY2309SI-1, CY2309SI-1H, CY2309SI-1HT, CY2309SI-1T. Updated <a href="#">Package Drawing and Dimensions</a> .
*L	3047136	KVM	10/04/2010	Added <a href="#">Ordering Code Definitions</a> under <a href="#">Ordering Information</a> . Updated <a href="#">Package Drawing and Dimensions</a> . Added <a href="#">Acronyms</a> and <a href="#">Units of Measure</a> .
*M	3146330	CXQ	01/18/2011	Added "Not recommended for new designs" statement to Features on page 1. Added 'not recommended for new designs' footnote to all parts in the ordering information table.
*N	3241160	BASH	05/09/2011	Added Footnote 9 on page 6 (CDT 97105). Removed first bullet point "Not recommended for new designs. The CY2305C and CY2309C are form, fit, function compatible devices with improved specifications." from Features section. (CDT 99798). Removed Footnote 20 and all its references from document. (CDT 99798).
*O	3400613	BASH	10/10/2011	Added Footnote 19 and its reference to all PLL lock time parameters throughout the document. Added <a href="#">Figure 10</a> for Stop Time Illustration.
*P	3859773	AJU	01/07/2013	Updated <a href="#">Ordering Information</a> (Updated part numbers). Updated <a href="#">Ordering Information</a> (Updated part numbers). Updated <a href="#">Package Drawing and Dimensions</a> : spec 51-85068 – Changed revision from *D to *E.
*Q	3997602	AJU	05/11/2013	Updated <a href="#">Package Drawing and Dimensions</a> : spec 51-85066 – Changed revision from *E to *F. Added <a href="#">Errata</a> .
*R	4124780	CINM	10/24/2013	Updated to new template. Completing Sunset Review.
*S	4307827	CINM	03/13/2014	Updated <a href="#">Errata</a> .
*T	4578443	TAVA	11/25/2014	Updated <a href="#">Functional Description</a> : Added "For a complete list of related documentation, click <a href="#">here</a> ." at the end. Updated <a href="#">Ordering Information</a> (Updated part numbers). Updated <a href="#">Ordering Information</a> (Updated part numbers).
*U	5206812	TAVA	04/05/2016	Updated <a href="#">Zero Delay and Skew Control</a> : Updated description. Updated <a href="#">Package Drawing and Dimensions</a> : spec 51-85066 – Changed revision from *F to *H. Updated to new template.
*V	5242499	SDHK / PSR	04/26/2016	Updated <a href="#">Electrical Characteristics</a> : Updated details in "Test Conditions" column corresponding to $V_{OL}$ and $V_{OH}$ parameters. Updated <a href="#">Operating Conditions</a> : Added $t_{pU}$ parameter and its details. Updated <a href="#">Electrical Characteristics</a> : Updated details in "Test Conditions" column corresponding to $V_{OL}$ and $V_{OH}$ parameters. Added <a href="#">Thermal Resistance</a> .
*W	5516682	TAVA	11/10/2016	Updated to new template. Completing Sunset Review.
*X	5708778	AESATMP7	04/27/2017	Updated Cypress Logo and Copyright.

## Sales, Solutions, and Legal Information

### Worldwide Sales and Design Support

Cypress maintains a worldwide network of offices, solution centers, manufacturer's representatives, and distributors. To find the office closest to you, visit us at [Cypress Locations](#).

#### Products

ARM® Cortex® Microcontrollers	<a href="http://cypress.com/arm">cypress.com/arm</a>
Automotive	<a href="http://cypress.com/automotive">cypress.com/automotive</a>
Clocks & Buffers	<a href="http://cypress.com/clocks">cypress.com/clocks</a>
Interface	<a href="http://cypress.com/interface">cypress.com/interface</a>
Internet of Things	<a href="http://cypress.com/iot">cypress.com/iot</a>
Lighting & Power Control	<a href="http://cypress.com/powerpsoc">cypress.com/powerpsoc</a>
Memory	<a href="http://cypress.com/memory">cypress.com/memory</a>
PSoC	<a href="http://cypress.com/psoc">cypress.com/psoc</a>
Touch Sensing	<a href="http://cypress.com/touch">cypress.com/touch</a>
USB Controllers	<a href="http://cypress.com/usb">cypress.com/usb</a>
Wireless/RF	<a href="http://cypress.com/wireless">cypress.com/wireless</a>

#### PSoC® Solutions

[PSoC 1](#) | [PSoC 3](#) | [PSoC 4](#) | [PSoC 5LP](#) | [PSoC 6](#)

#### Cypress Developer Community

[Forums](#) | [WICED IoT Forums](#) | [Projects](#) | [Video](#) | [Blogs](#) | [Training](#) | [Components](#)

#### Technical Support

[cypress.com/support](http://cypress.com/support)

---

© Cypress Semiconductor Corporation, 2001-2017. This document is the property of Cypress Semiconductor Corporation and its subsidiaries, including Spansion LLC ("Cypress"). This document, including any software or firmware included or referenced in this document ("Software"), is owned by Cypress under the intellectual property laws and treaties of the United States and other countries worldwide. Cypress reserves all rights under such laws and treaties and does not, except as specifically stated in this paragraph, grant any license under its patents, copyrights, trademarks, or other intellectual property rights. If the Software is not accompanied by a license agreement and you do not otherwise have a written agreement with Cypress governing the use of the Software, then Cypress hereby grants you a personal, non-exclusive, nontransferable license (without the right to sublicense) (1) under its copyright rights in the Software (a) for Software provided in source code form, to modify and reproduce the Software solely for use with Cypress hardware products, only internally within your organization, and (b) to distribute the Software in binary code form externally to end users (either directly or indirectly through resellers and distributors), solely for use on Cypress hardware product units, and (2) under those claims of Cypress's patents that are infringed by the Software (as provided by Cypress, unmodified) to make, use, distribute, and import the Software solely for use with Cypress hardware products. Any other use, reproduction, modification, translation, or compilation of the Software is prohibited.

TO THE EXTENT PERMITTED BY APPLICABLE LAW, CYPRESS MAKES NO WARRANTY OF ANY KIND, EXPRESS OR IMPLIED, WITH REGARD TO THIS DOCUMENT OR ANY SOFTWARE OR ACCOMPANYING HARDWARE, INCLUDING, BUT NOT LIMITED TO, THE IMPLIED WARRANTIES OF MERCHANTABILITY AND FITNESS FOR A PARTICULAR PURPOSE. To the extent permitted by applicable law, Cypress reserves the right to make changes to this document without further notice. Cypress does not assume any liability arising out of the application or use of any product or circuit described in this document. Any information provided in this document, including any sample design information or programming code, is provided only for reference purposes. It is the responsibility of the user of this document to properly design, program, and test the functionality and safety of any application made of this information and any resulting product. Cypress products are not designed, intended, or authorized for use as critical components in systems designed or intended for the operation of weapons, weapons systems, nuclear installations, life-support devices or systems, other medical devices or systems (including resuscitation equipment and surgical implants), pollution control or hazardous substances management, or other uses where the failure of the device or system could cause personal injury, death, or property damage ("Unintended Uses"). A critical component is any component of a device or system whose failure to perform can be reasonably expected to cause the failure of the device or system, or to affect its safety or effectiveness. Cypress is not liable, in whole or in part, and you shall and hereby do release Cypress from any claim, damage, or other liability arising from or related to all Unintended Uses of Cypress products. You shall indemnify and hold Cypress harmless from and against all claims, costs, damages, and other liabilities, including claims for personal injury or death, arising from or related to any Unintended Uses of Cypress products.

Cypress, the Cypress logo, Spansion, the Spansion logo, and combinations thereof, WICED, PSoC, CapSense, EZ-USB, F-RAM, and Traveo are trademarks or registered trademarks of Cypress in the United States and other countries. For a more complete list of Cypress trademarks, visit [cypress.com](http://cypress.com). Other names and brands may be claimed as property of their respective owners.

## Looking for pricing, stock, or lifecycle information?

Click below to explore more details on WIN SOURCE:

- ⊖ [View CY2305SXC-1H on WIN SOURCE](#)
- ⊖ [Cypress Semiconductor Corp Information](#)

## Optimize Your Supply Chain with WIN SOURCE Solutions

- ✓ Global Sourcing Solution
- ✓ Obsolete Management
- ✓ Cost Control Management
- ✓ Shortage Management
- ✓ Alternative Solution
- ✓ Excess Inventory Management