



**THE DATASHEET OF
SH01S1515A**



FEATURES

- Efficiency up to 80%
- SMD Package with Industry Standard Pinout
- Operating Temperature Range -40°C to $+85^{\circ}\text{C}$
- Moisture sensitivity level (MSL) 2
- Isolation Voltage 1500 VDC
- High Accuracy of Pin Planarity
- Lead free, RoHS Compliant
- 3 Years Product Warranty
- UL/cUL 62368-1, UL/cUL 60950-1 approval



The SH01S/D series is miniature, SMD Package, isolated 1W DC/DC converters with 1,500VDC isolation. It allows a wide operating temperature range of -40°C to $+85^{\circ}\text{C}$. These isolated DC/DC converters are the latest offering from a world leader in power systems technology and manufacturing — Delta Electronics, Inc

Model List

Model Number	Input Voltage (Range) VDC	Output Voltage VDC	Output Current		Input Current		Load Regulation % (max.)	Max. capacitive Load uF	Efficiency (typ.)		
			Max. mA	Min. mA	@Max. Load mA(typ.)	@No Load mA(typ.)			@Max. Load %		
SH01S0503A	5 (4.5 ~ 5.5)	3.3	300	6	271	30	10	33	73		
SH01S0505A		5	200	4	256		10		78		
SH01S0509A		9	110	2	254		10		78		
SH01S0512A		12	84	1.5	259		8	78			
SH01S0515A		15	67	1	254		7	79			
SH01D0505A		± 5	± 100	± 2	270		10	74			
SH01D0512A		± 12	± 42	± 0.8	259		8	33*	78		
SH01D0515A		± 15	± 33	± 0.7	254		7	78			
SH01S1203A		12 (10.8 ~ 13.2)	3.3	300	6		112	15	8	33	74
SH01S1205A			5	200	4		109		8		76
SH01S1209A	9		110	2	106	8	78				
SH01S1212A	12		84	1.5	106	5	79				
SH01S1215A	15		67	1	105	5	80				
SH01D1205A	± 5		± 100	± 2	113	8	74				
SH01D1212A	± 12		± 42	± 0.8	108	5	33*		78		
SH01D1215A	± 15		± 33	± 0.7	104	5	79				
SH01S1512A	15 (13.5 ~ 16.5)		12	84	1.5	86	14		5	33	78
SH01S1515A			15	67	1	86			5		78
SH01S2403A		3.3	300	6	58	8		8	33		72
SH01S2405A		5	200	4	54			8		78	
SH01S2409A		9	110	2	54			8		77	
SH01S2412A		12	84	1.5	55			5		77	
SH01S2415A	15	67	1	53	5		79				
SH01D2405A	± 5	± 100	± 2	57	8		73				
SH01D2412A	± 12	± 42	± 0.8	54	9	5	33*	78			
SH01D2415A	± 15	± 33	± 0.7	53		5	78				

* For each output



Input Characteristics

Parameter	Model	Min.	Typ.	Max.	Unit
Input Voltage Range	5V Input Models	4.5	5	5.5	VDC
	12V Input Models	10.8	12	13.2	
	15V Input Models	13.5	15	16.5	
	24V Input Models	21.6	24	26.4	
Input Surge Voltage (1 sec. max.)	5V Input Models	-0.7	---	9	
	12V Input Models	-0.7	---	18	
	15V Input Models	-0.7	---	20	
	24V Input Models	-0.7	---	30	
Reverse Polarity Input Current	All Models	---	---	0.3	A
Input Filter		Internal Capacitor			
Internal Power Dissipation		---	---	450	mW

Output Characteristics

Parameter	Conditions	Min.	Typ.	Max.	Unit
Output Voltage Balance	Dual Output, Balanced Loads	---	±0.1	±1.0	%
Line Regulation	For Vin Change of 1%	---	±1.2	±1.5	%
Load Regulation	Io=20% to 100%	See Model Selection Guide			
Ripple & Noise (20MHz)		---	60	120	mV _{P-P}
Ripple & Noise (20MHz)	Over Line, Load & Temp.	---	---	150	mV _{P-P}
Ripple & Noise (20MHz)		---	---	15	mV rms
Temperature Coefficient		---	±0.01	±0.02	%/°C
Short Circuit Protection		0.5 Second Max.			

General Characteristics

Parameter	Conditions	Min.	Typ.	Max.	Unit
I/O Isolation Voltage (rated)	60 Seconds	1500	---	---	VDC
I/O Isolation Resistance	500 VDC	1000	---	---	MΩ
I/O Isolation Capacitance	100KHz, 1V	---	40	100	pF
Switching Frequency		50	100	140	KHz
MTBF (calculated)	MIL-HDBK-217F@25°C, Ground Benign	2,000,000	---	---	Hours
Safety Approvals	UL/cUL 62368-1, UL/cUL 60950-1 recognition(CSA certificate)				
Moisture Sensitivity Level (MSL)	IPC/JEDEC J-STD-020D				Level 2

Recommended Input Fuse

5V Input Models	12V Input Models	15V Input Models	24V Input Models
500mA Slow-Blow Type	200mA Slow-Blow Type	150mA Slow-Blow Type	100mA Slow-Blow Type

Environmental Specifications

Parameter	Conditions	Min.	Max.	Unit
Operating Temperature Range (with Derating)	Ambient	-40	+85	°C
Case Temperature		---	+90	°C
Storage Temperature Range		-50	+125	°C
Humidity (non condensing)		---	95	% rel. H
Cooling	Free-Air convection			
Lead Temperature (1.5mm from case for 10Sec.)		---	260	°C

Output Voltage Tolerance

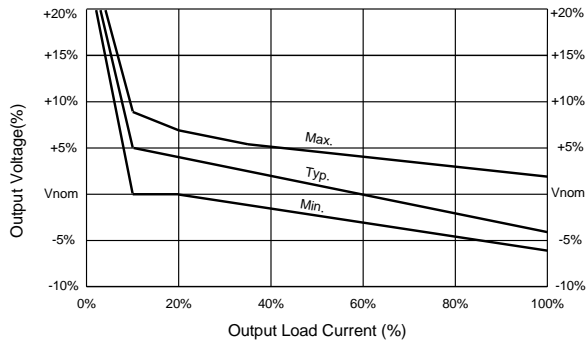

(3.3V & 5V Output)

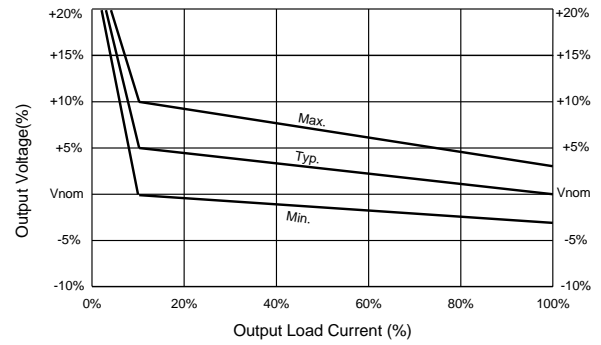

(All other Output)

Power Derating Curve

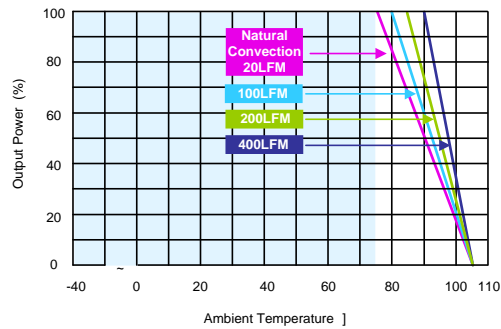

Notes

- 1 Specifications typical at $T_a = +25^\circ\text{C}$, resistive load, nominal input voltage and rated output current unless otherwise noted.
- 2 Ripple & Noise measurement bandwidth is 0-20MHz.
- 3 These power converters require a minimum output loading to maintain specified regulation, operation under no-load conditions will not damage these modules; however they may not meet all specifications listed.
- 4 All DC/DC converters should be externally fused at the front end for protection.
- 5 That "natural convection" is about 20LFM but is not equal to still air (0 LFM).
- 6 Specifications subject to change without notice.
- 7 It is not recommended to use water-washing process on SMT units.

Mechanical Drawing

Mechanical Dimensions (Single Output)

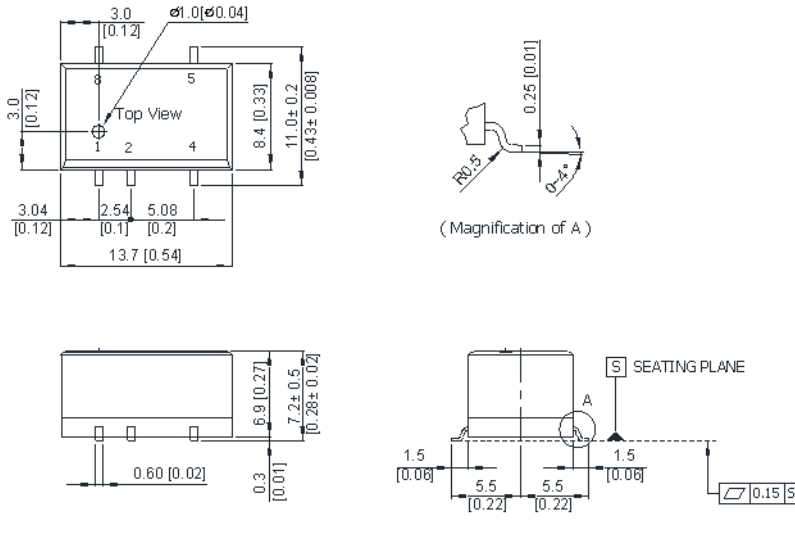

Connecting Pin Patterns

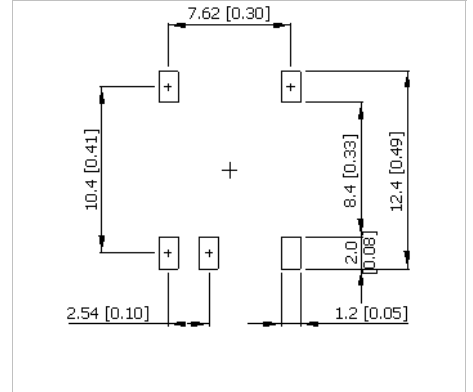

Mechanical Dimensions (Dual Output)

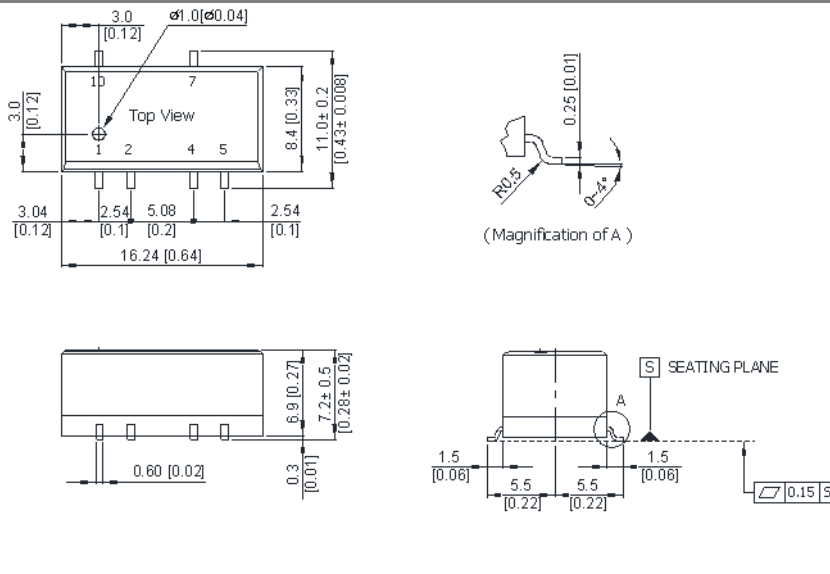

Connecting Pin Patterns

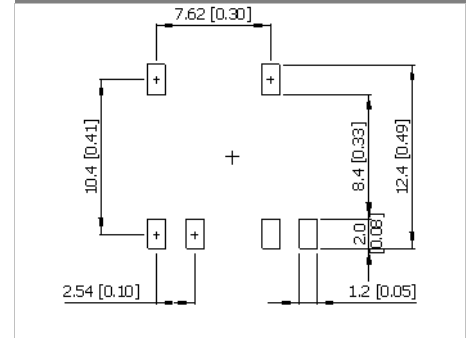

- ▶ All dimensions in mm (inches)
- ▶ Tolerance: X.X±0.25 (X.XX±0.01)
X.XX±0.13 (X.XXX±0.005)
- ▶ Pins ±0.05 (±0.002)

Pin Connections

Pin	Single Output	Dual Output
1	-Vin	-Vin
2	+Vin	+Vin
3	No Pin	No Pin
4	-Vout	Common
5	+Vout	-Vout
6	No Pin	No Pin
7	No Pin	+Vout
8	NA	No Pin
9	---	No Pin
10	---	NA

NA : Not Available for Electrical Connection

Physical Outline

Case Size (Single Output)	: 13.7x8.0x6.7mm (0.54x0.31x0.26 Inches)
Case Size (Dual Output)	: 16.24x8.0x6.7mm (0.64x0.31x0.26 Inches)
Case Material	: Non-Conductive Black Plastic (flammability to UL 94V-0 rated)
Weight (Single Output)	: 1.7g
Weight (Dual Output)	: 2.0g



Part Numbering System

S	H	01	S	05	05	A
Form factor	Family series	Watt	Number of Outputs	Input Voltage	Output Voltage	Option Code
D-DIP	A-Z	01:1W	S - Single	03:3.3V	03:3.3V	A - Std. Functions
P-SIP		02:2W	D- Dual	05: 5V	05: 5V	
S-SMD		03:3W		12:12V	12:12V	
		04:4W		24: 24V	15: 15V	
		06:6W		48:48V	24: 24V	

WARRANTY

Delta offers a three(3) years limited warranty. Complete warranty information is listed on our web site or is available upon request from Delta.

Information furnished by Delta is believed to be accurate and reliable. However, no responsibility is assumed by Delta for its use, nor for any infringements of patents or other rights of third parties, which may result from its use. No license is granted by implication or otherwise under any patent or patent rights of Delta. Delta reserves the right to revise these specifications at any time, without notice.







Looking for pricing, stock, or lifecycle information?

Click below to explore more details on WIN SOURCE:

 [View SH01S1515A on WIN SOURCE](#)

 [Delta Electronics](#) Information

Optimize Your Supply Chain with WIN SOURCE Solutions

-  Global Sourcing Solution
-  Obsolete Management
-  Cost Control Management
-  Shortage Management
-  Alternative Solution
-  Excess Inventory Management